

LEGO

EXO-FORCE



7713

Book 1



白雷

EXO

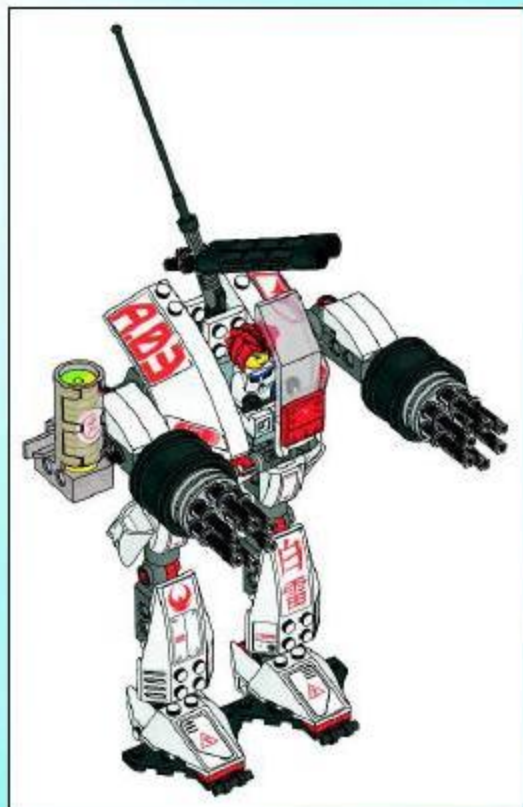

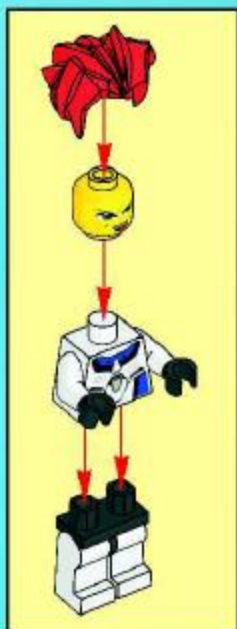

1

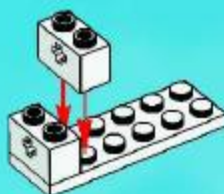

2

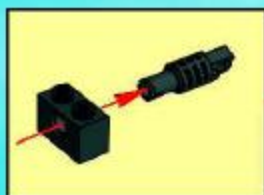



2x

3



2x

4



1x



2x

5





2x

6

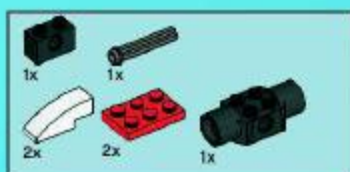

7

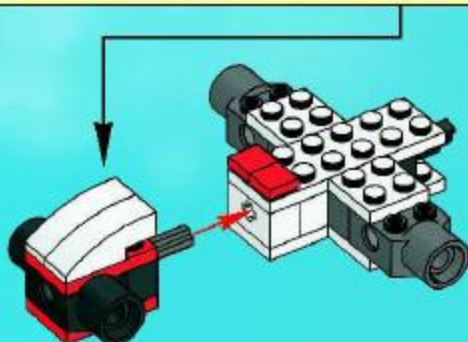
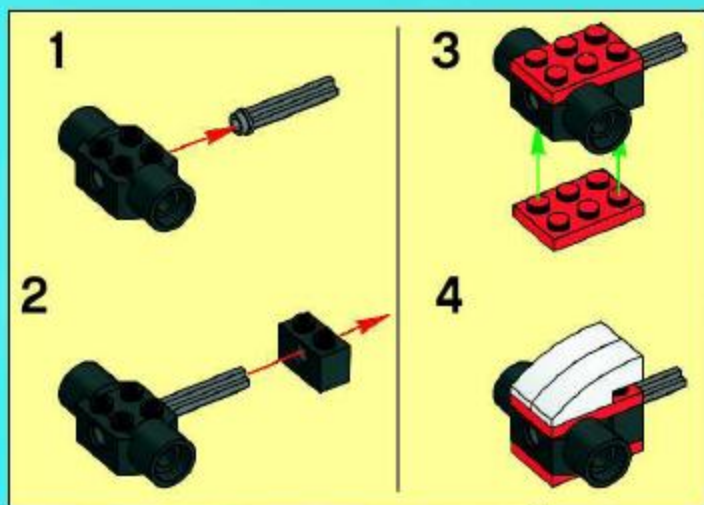



8

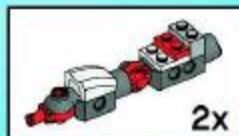
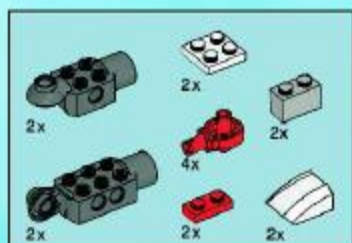
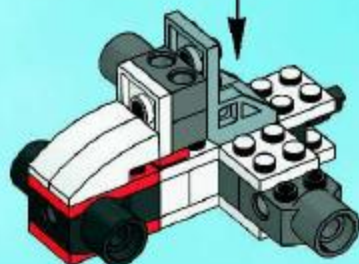
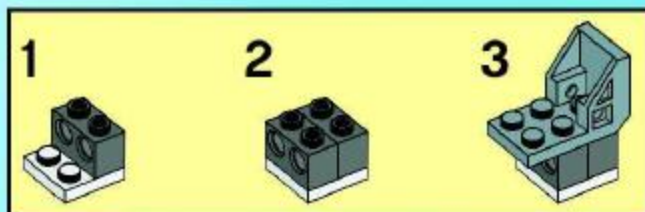

9

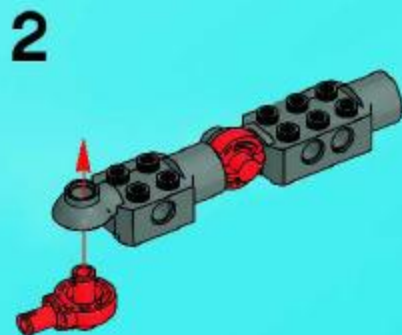

3

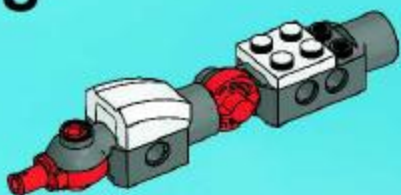

4

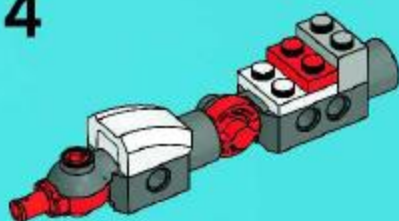

2x

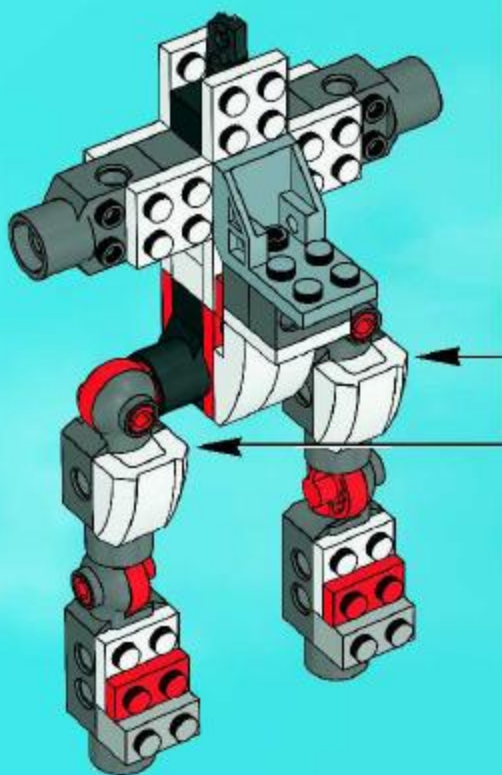

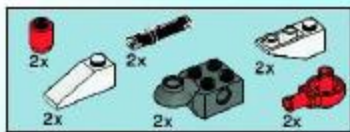

10

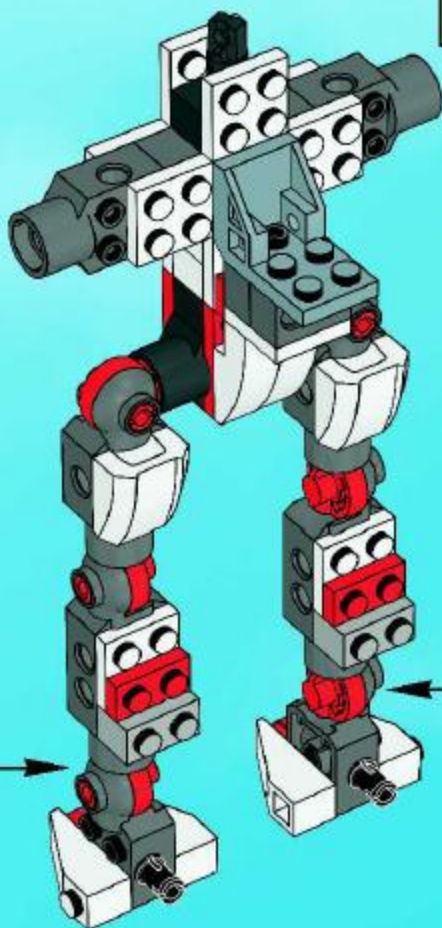
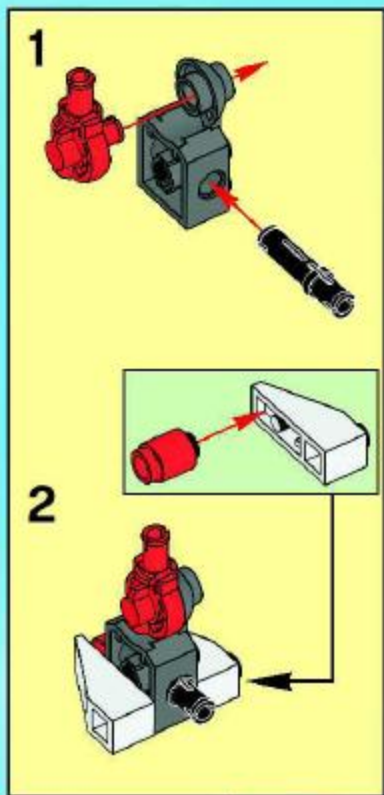
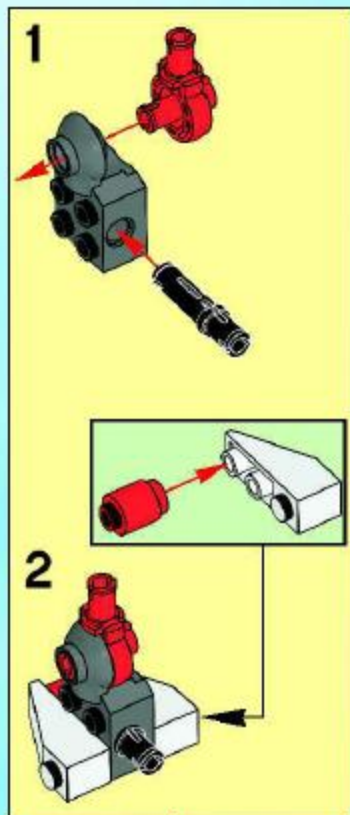

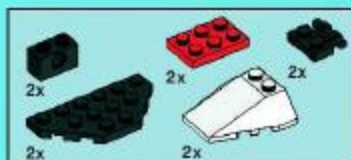

11

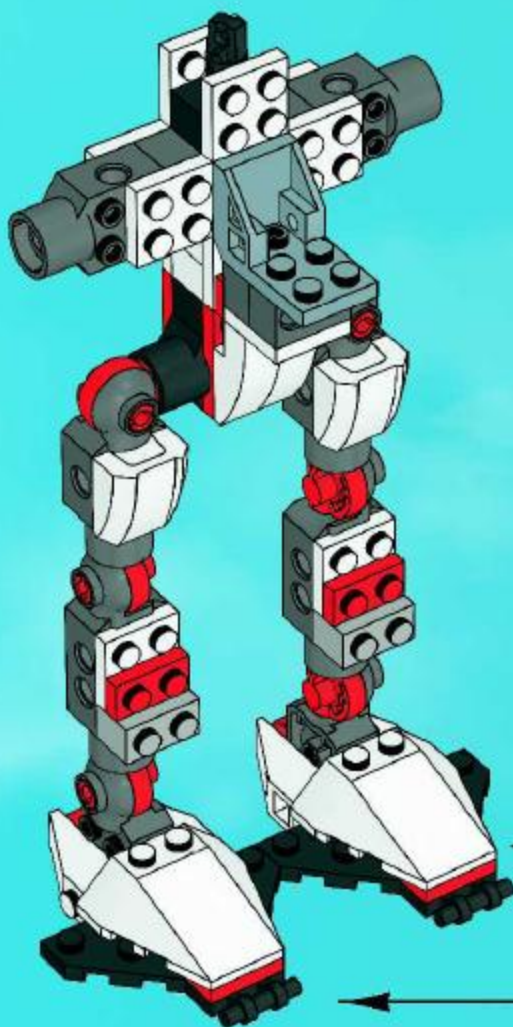
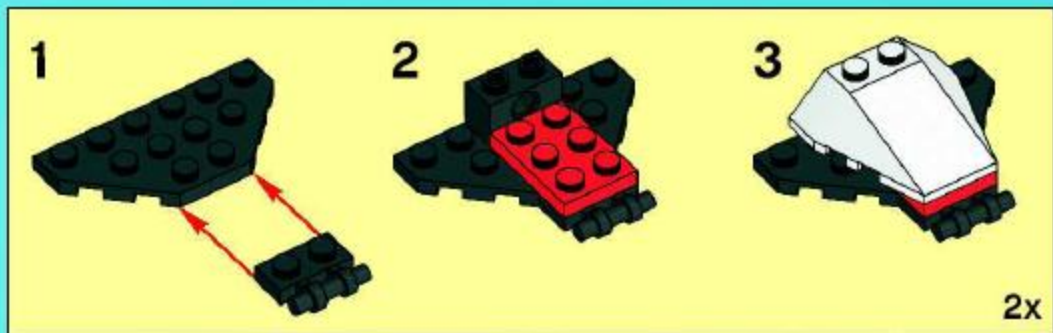

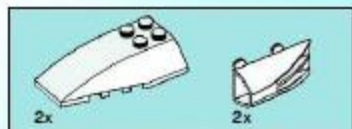

12

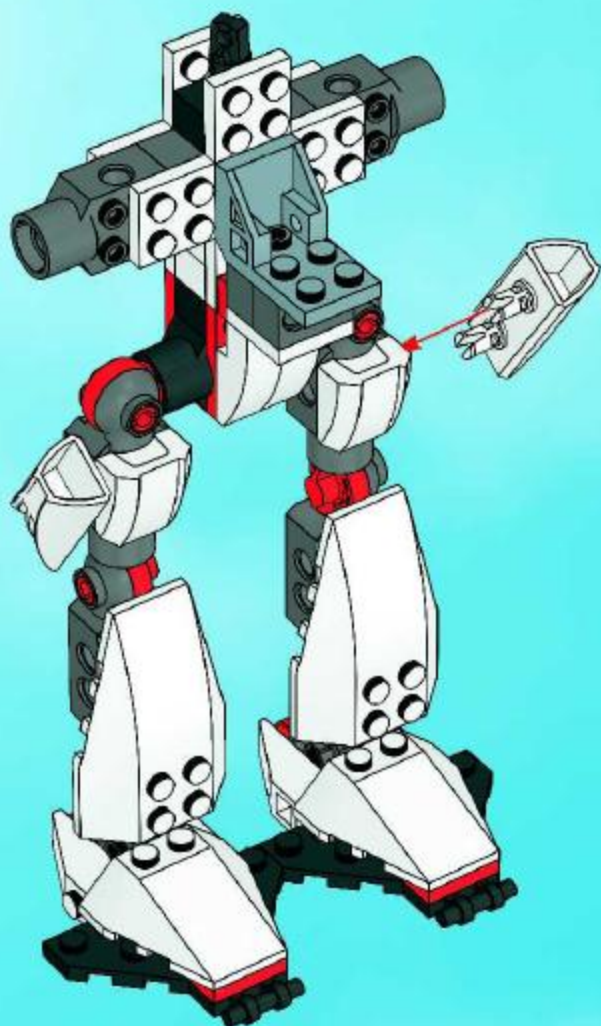

13

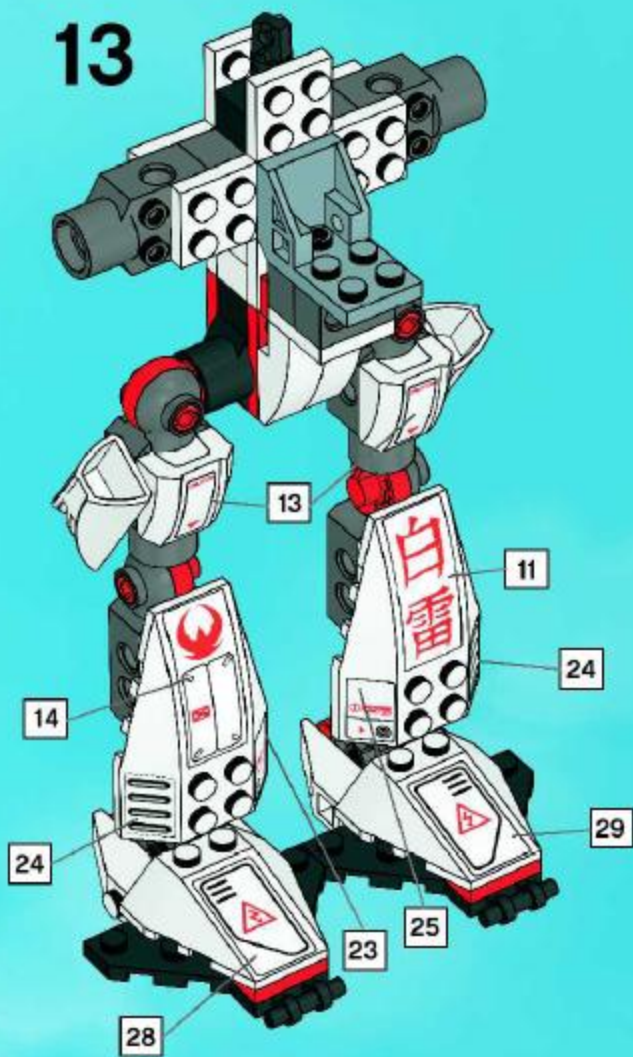



14

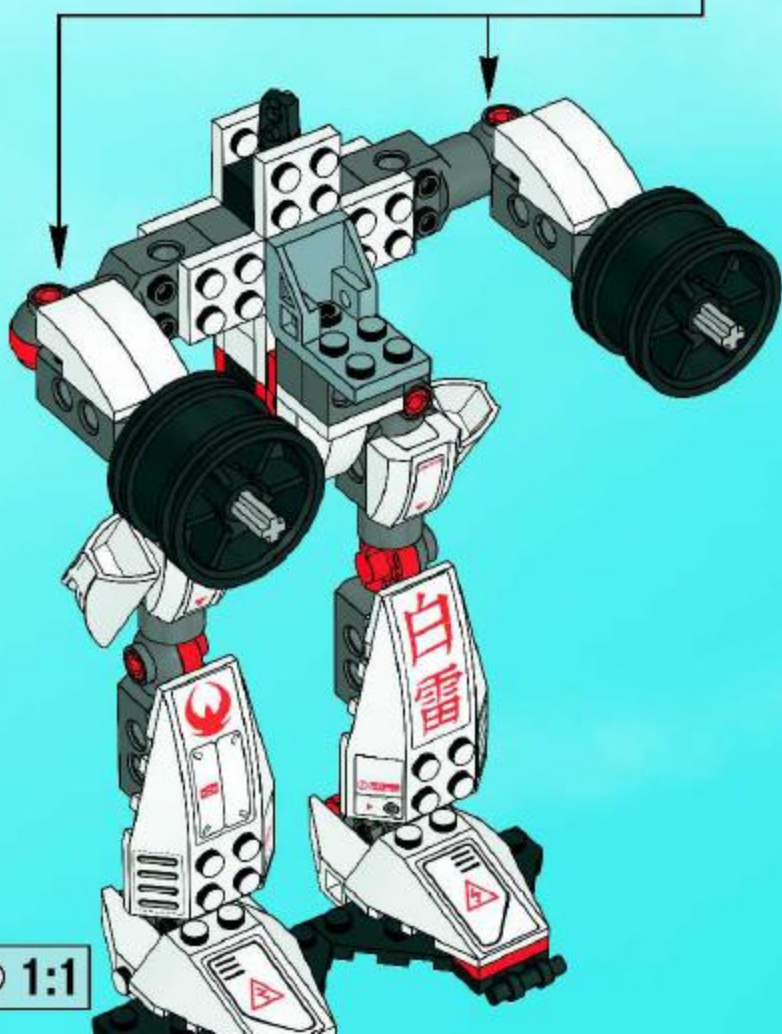
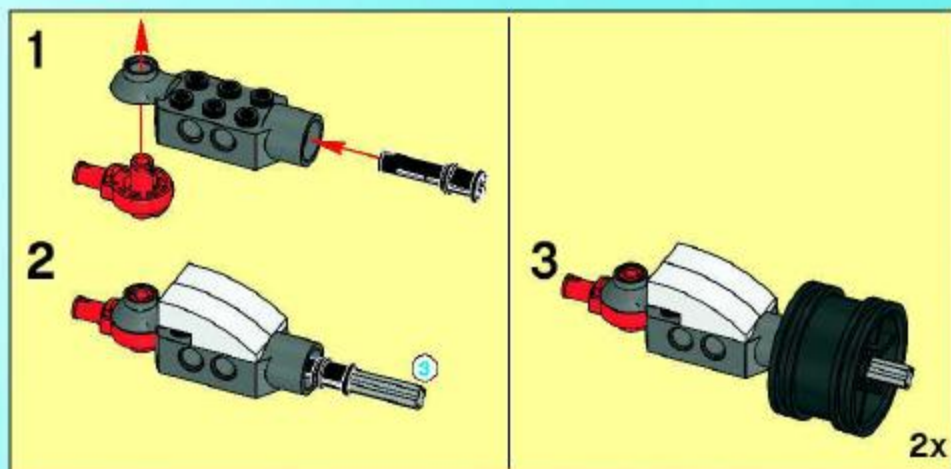

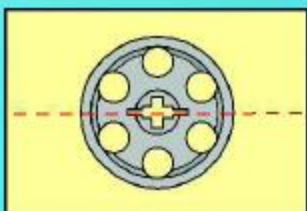

15

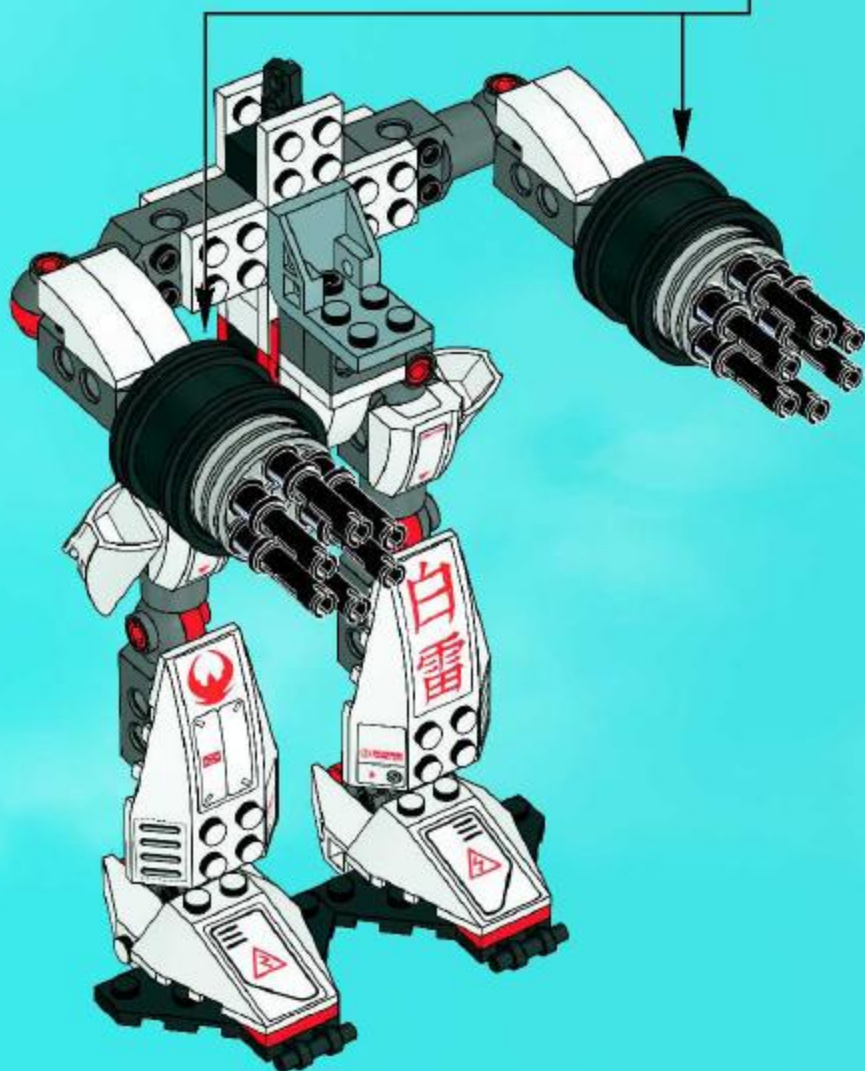
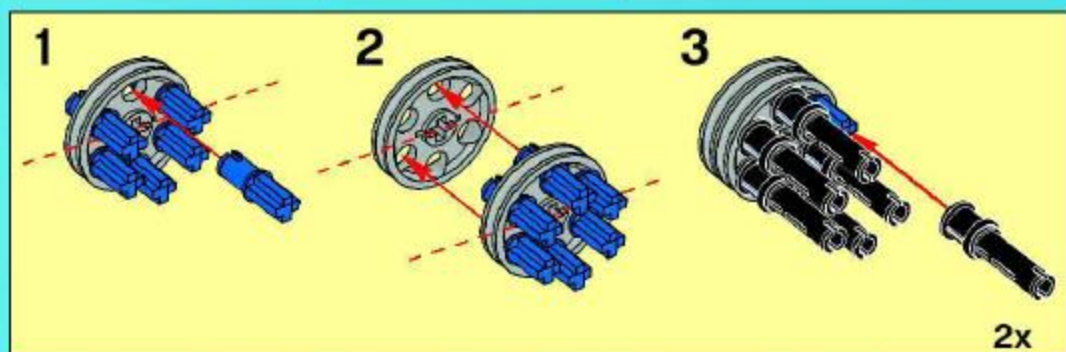



16

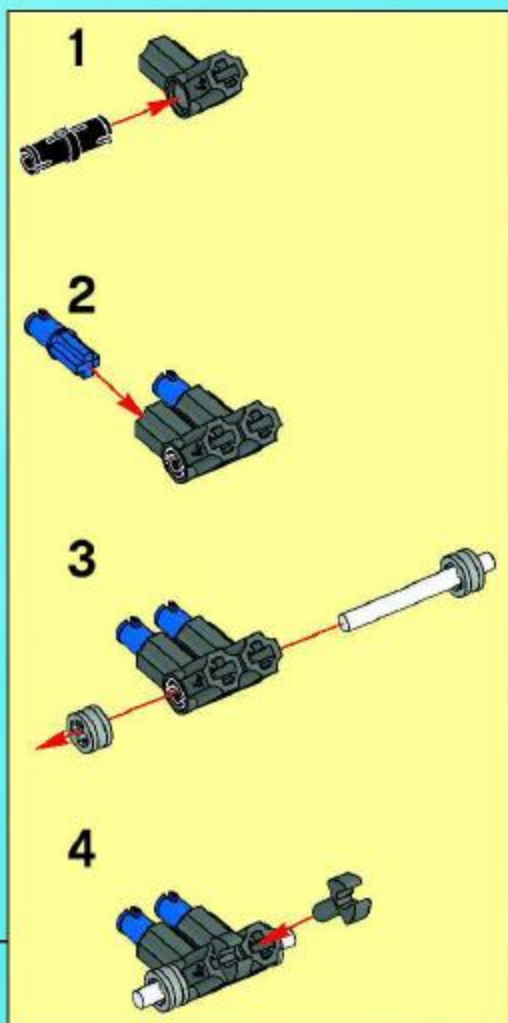
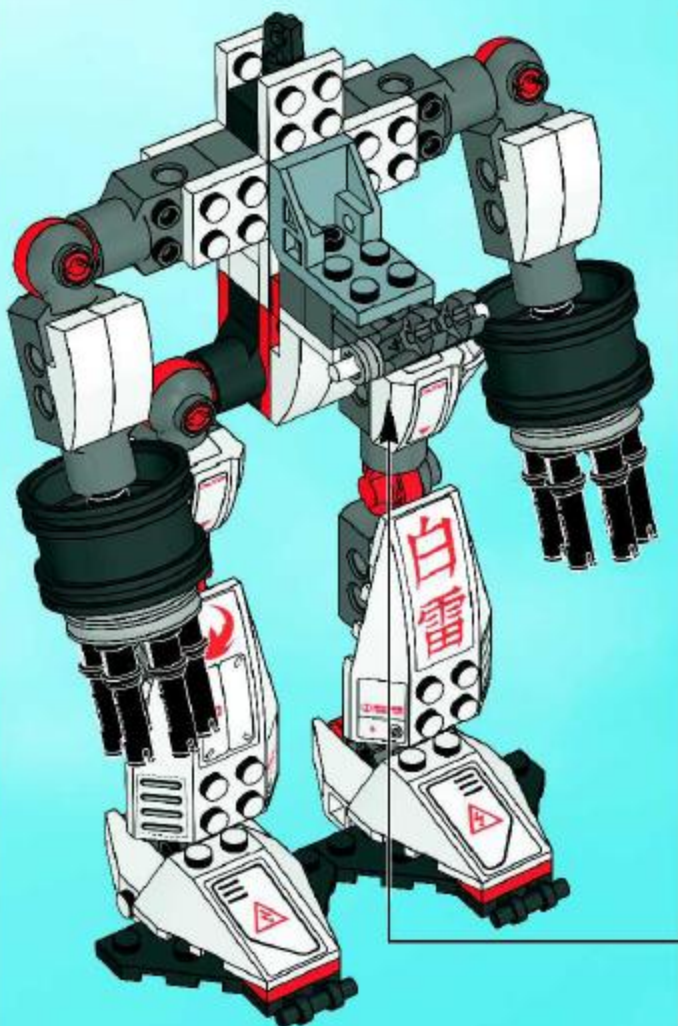

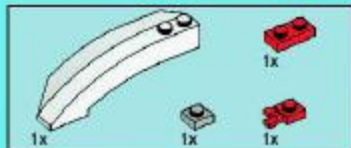

17

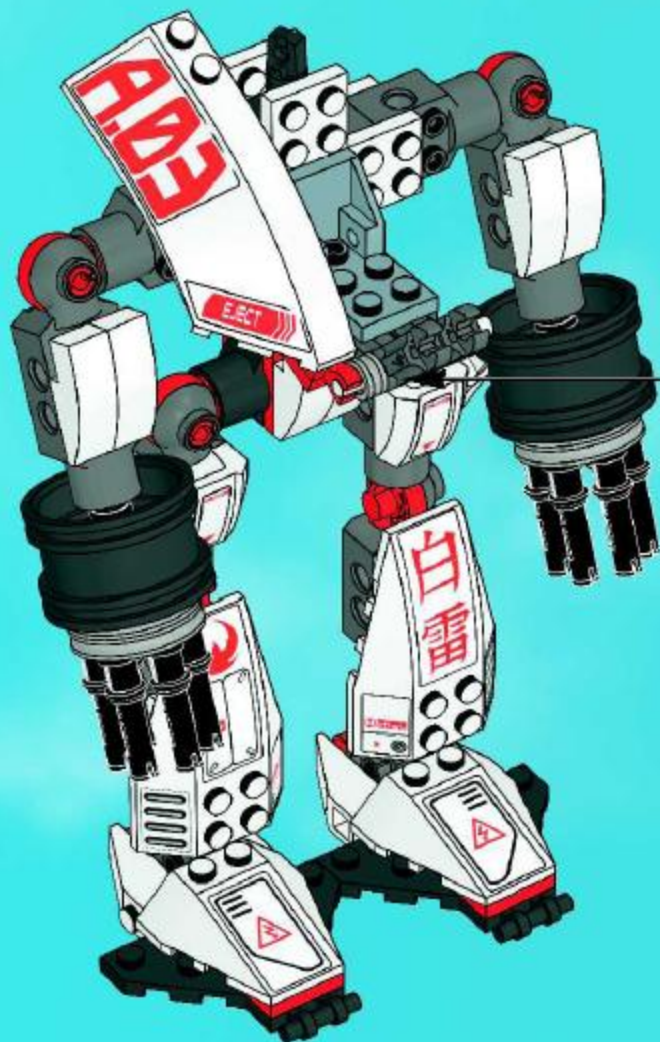
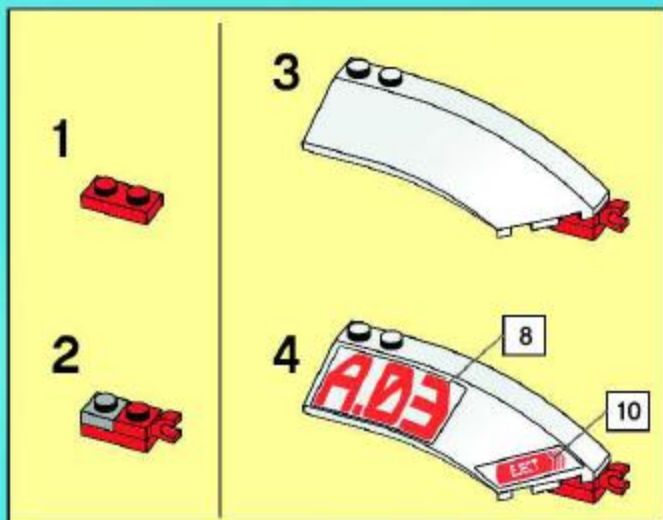



18

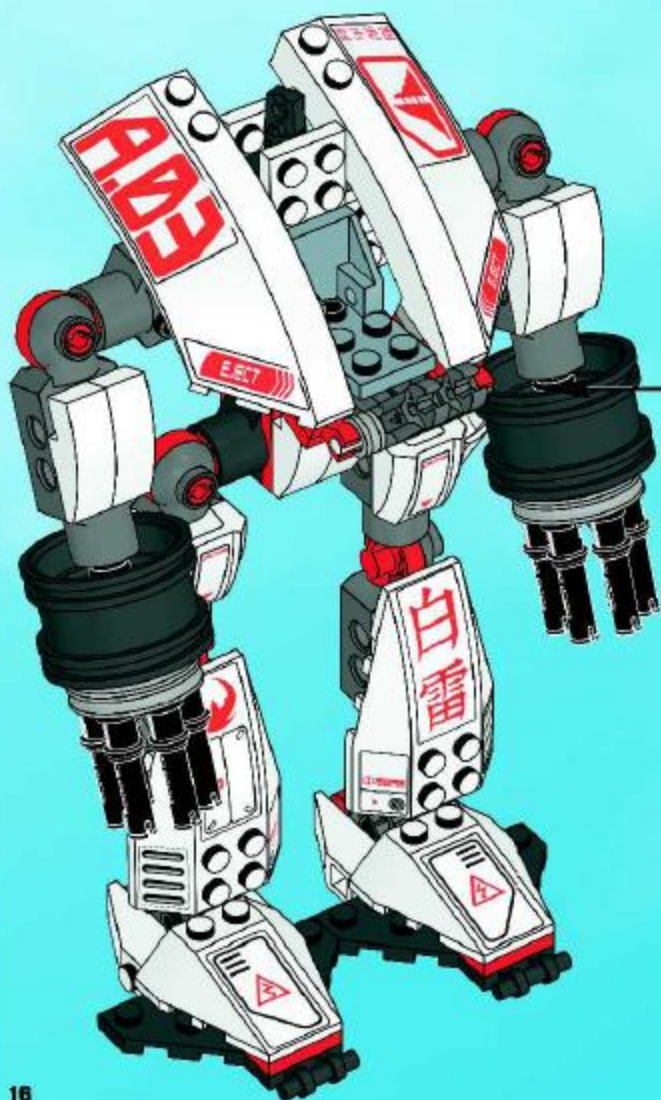
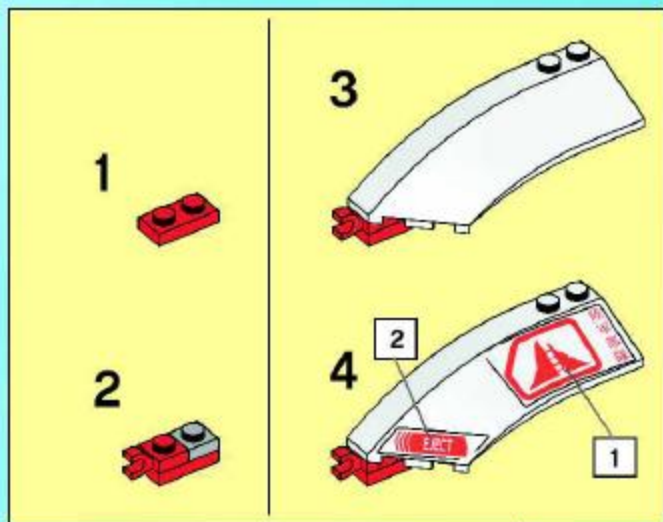



19

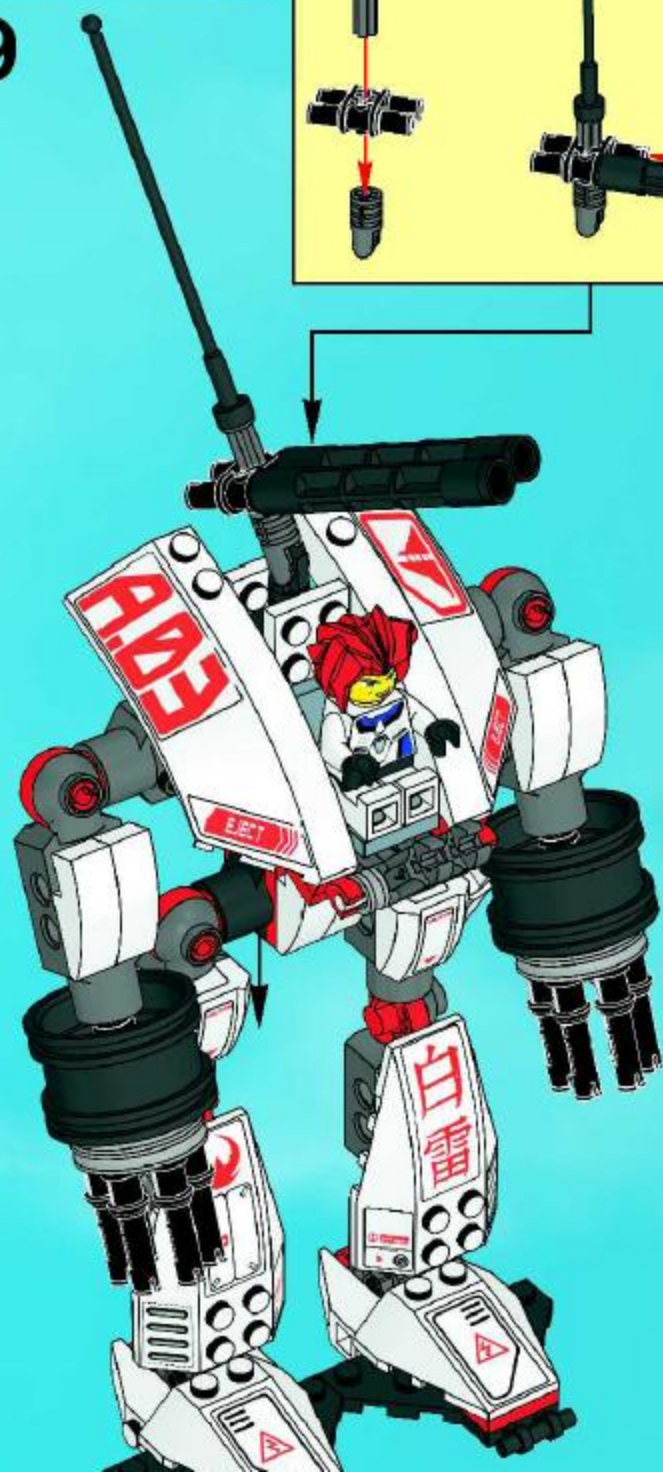
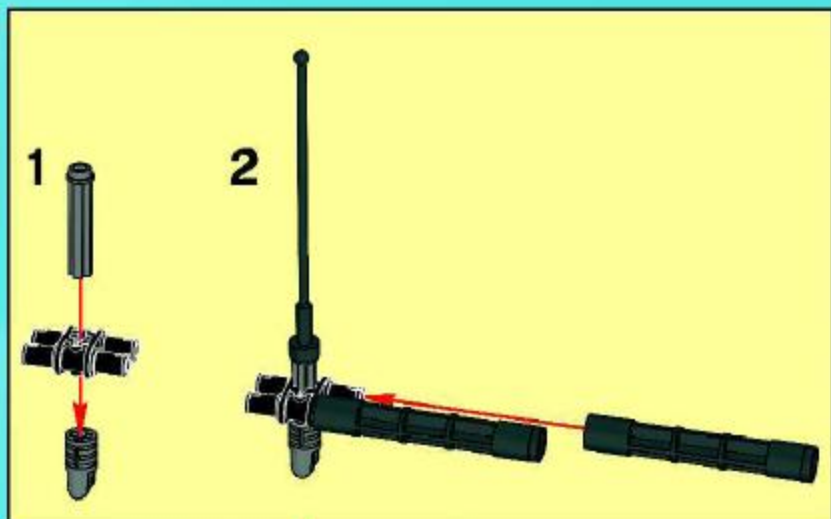

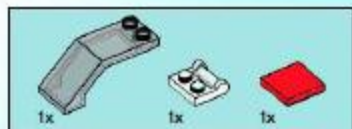

20

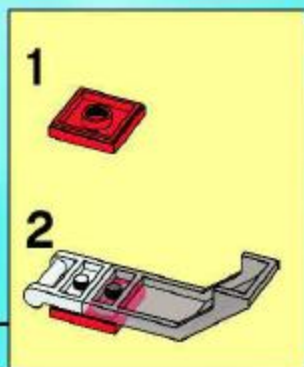

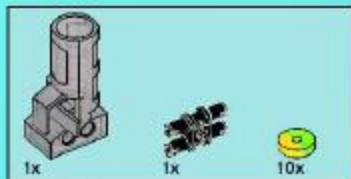

21

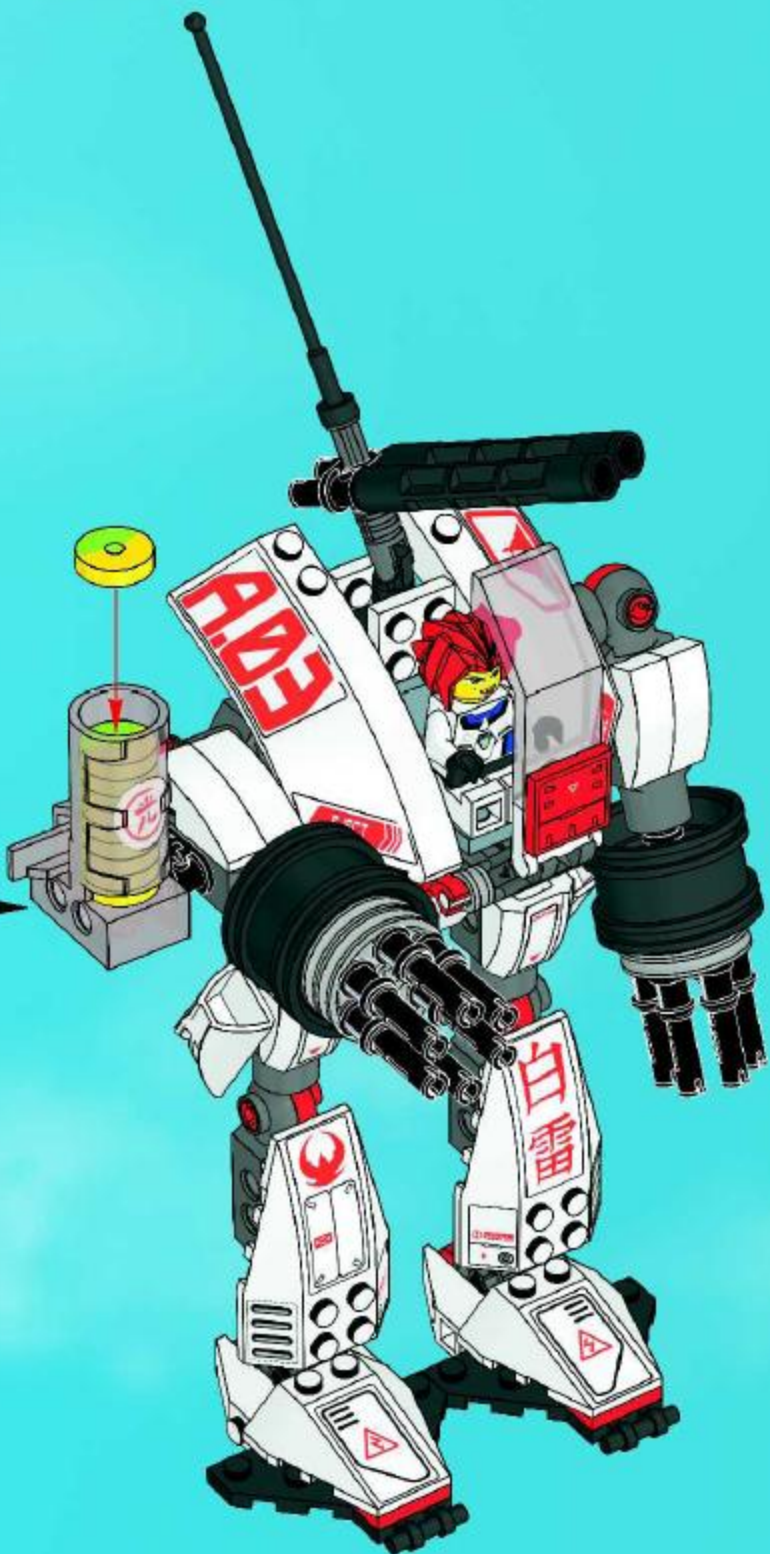
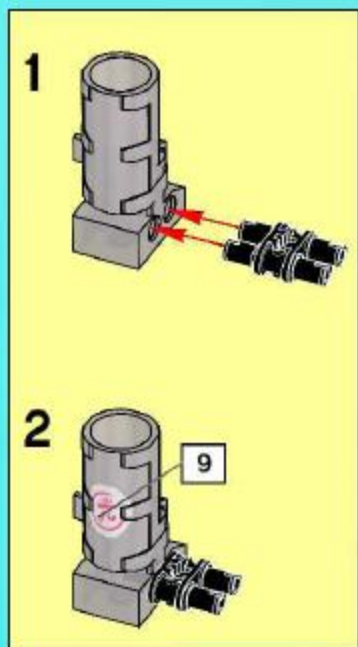

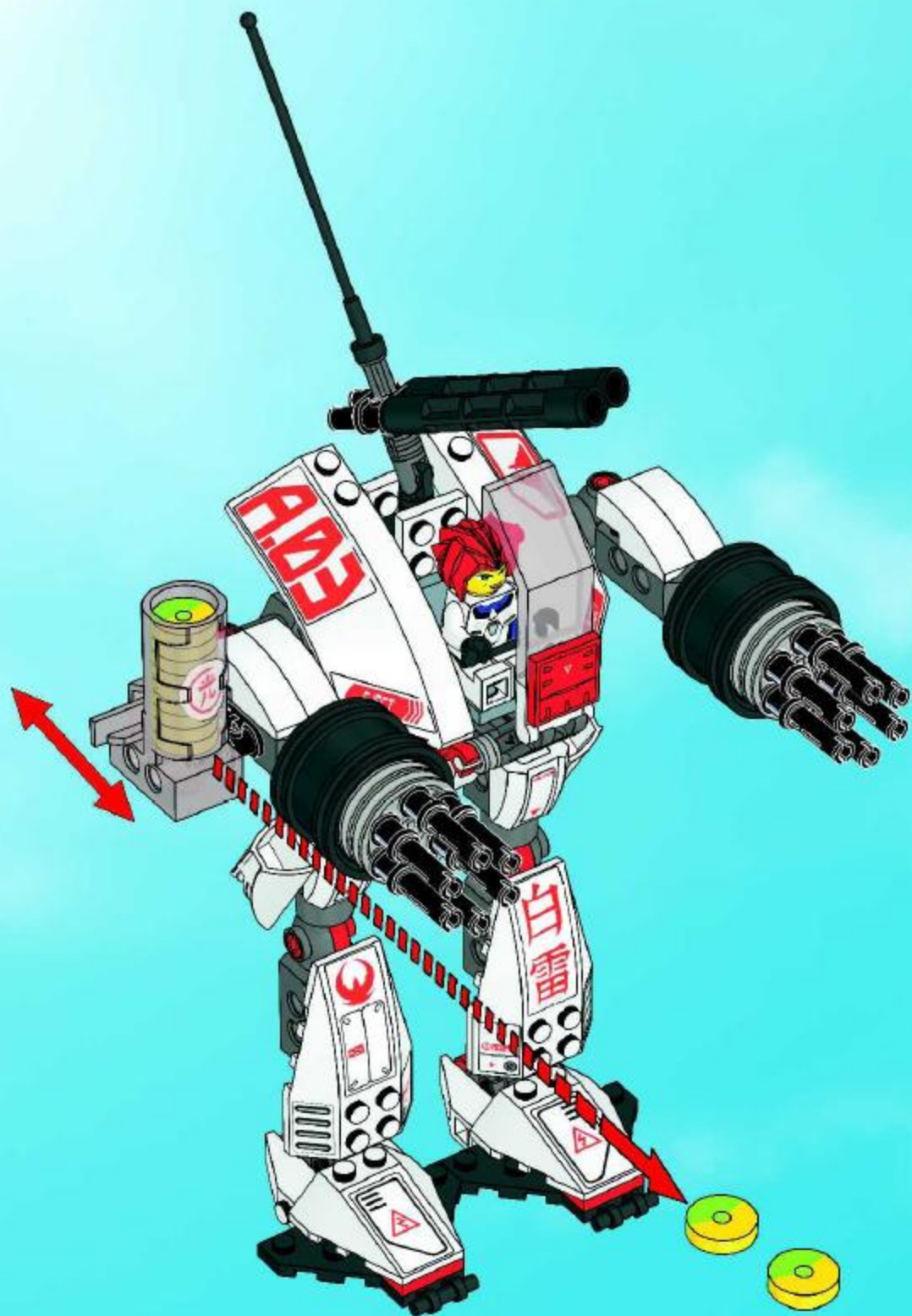



Raven Attacker

Fire Eagle

Alternative models

- Alternatives Modell
- Modelo alternativo
- Modèle alternatif
- Modelo alternativo
- Alternativ modell

www.EXO-FORCE.com







www.EXO-FORCE.com



©2008 The LEGO Group. 4502365

LEGO

EXO-FORCE



7713

Book 2



白雷

雷



- 1x 448397
- 2x 418325
- 1x 4273278
- 4x 42710359
- 4x 4225875
- 3x 42110366
- 3x 42110388
- 2x 42110723
- 2x 42111003
- 3x 42110050
- 2x 4225073
- 2x 4227399
- 1x 42110025
- 2x 42110893
- 4x 42111333
- 2x 42110556
- 3x 4107559
- 7x 370320
- 4x 42493919
- 12x 303328
- 1x 4184400
- 4x 4262615
- 1x 42773827
- 2x 42110834
- 2x 4211441
- 2x 42110336
- 1x 4211493
- 2x 4211353
- 3x 4211398
- 7x 4211448
- 4x 4211565
- 8x 4211396
- 4x 4180345
- 4x 014320
- 4x 4180913
- 2x 4202938
- 4x 4213374
- 6x 4194583
- 1x 394226
- 4x 4225900
- 2x 4180550
- 2x 398526
- 4x 302526
- 2x 4387713
- 1x 4200486
- 2x 4159103
- 1x 4238017
- 4x 4144525
- 4x 4225487
- 2x 4226628
- 2x 256626
- 2x 473287
- 2x 4106572
- 3x 4103524
- 2x 4201592
- 1x 4200482
- 2x 4103300
- 2x 3008841
- 4x 4163557
- 4x 4273860
- 8x 4107106
- 30x 3005199
- 2x 4204024
- 1x 4281254
- 2x 4270734
- 4x 4494219
- 2x 4140301
- 1x 4400434
- 1x 4227398
- 2x 4210597
- 2x 4263001
- 4x 4494900
- 4x 4494925
- 2x 4184909
- 1x 4597302
- 2x 4408643
- 2x 4498844

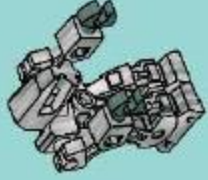
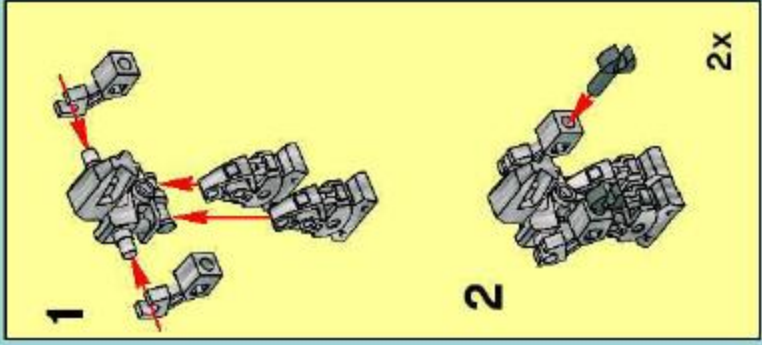

1

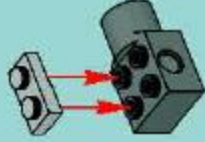



2

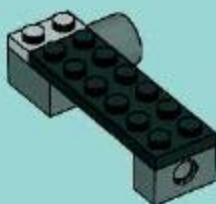

3



4

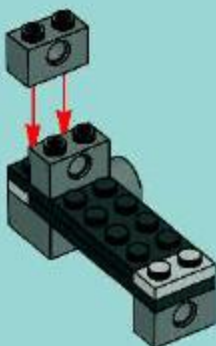

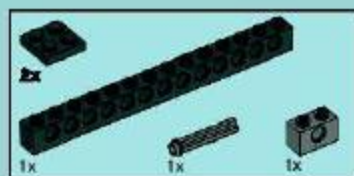

5

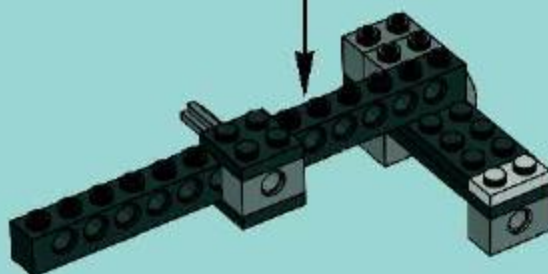
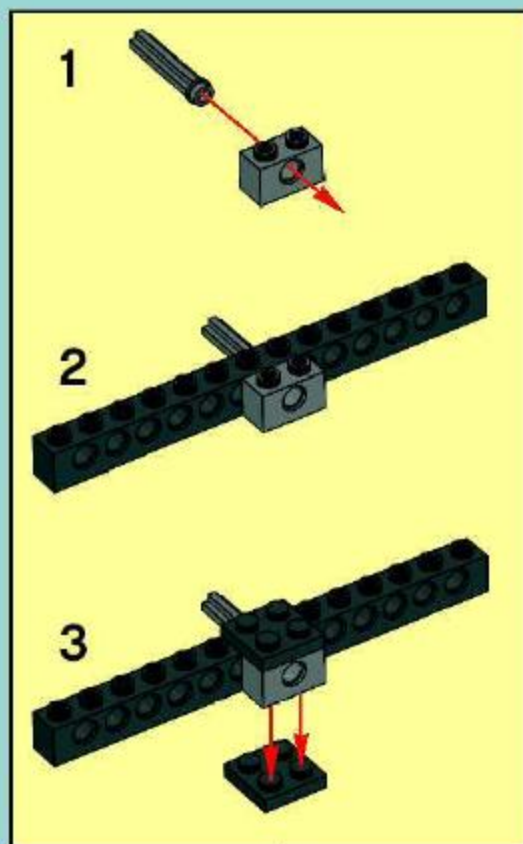

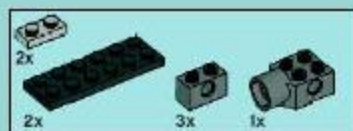

6

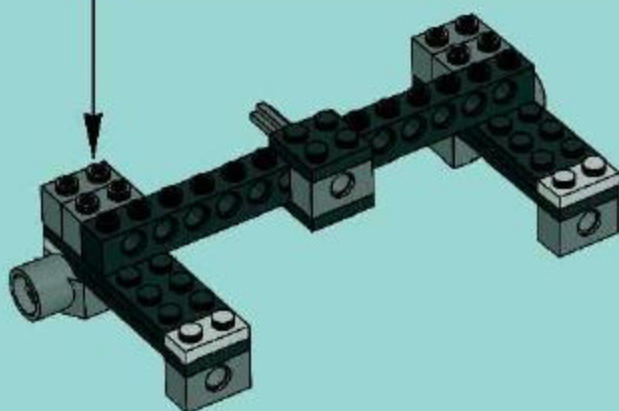
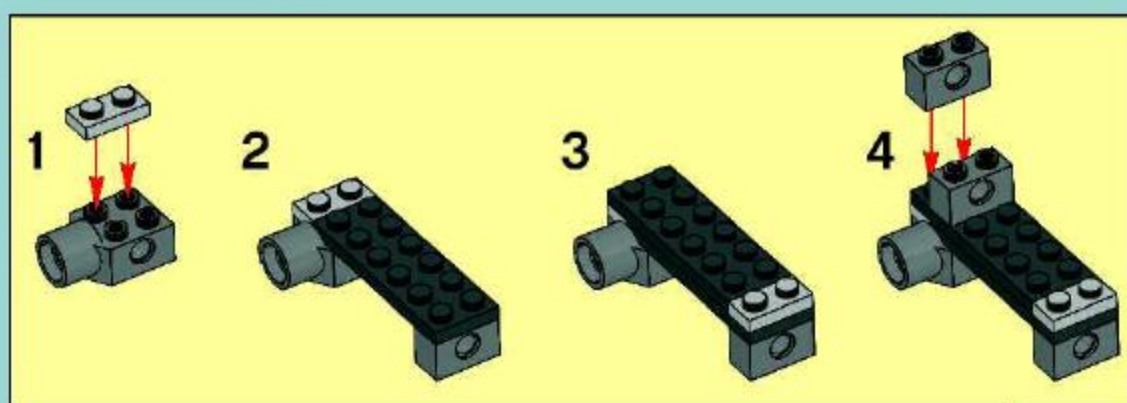

7

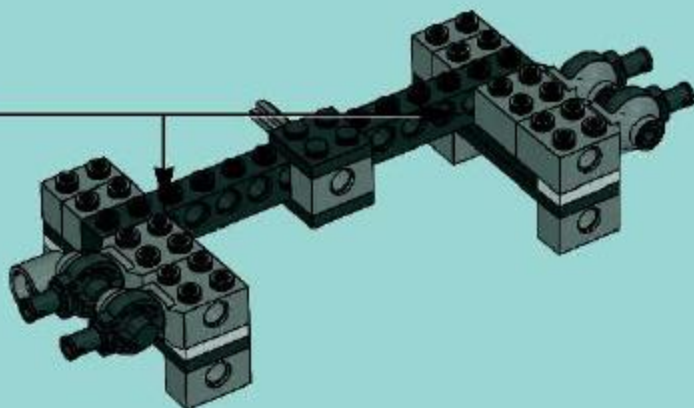
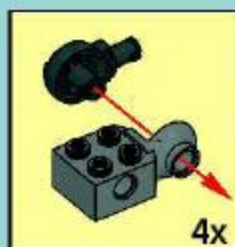



8

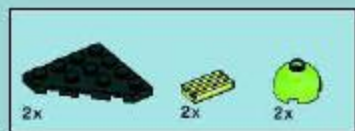
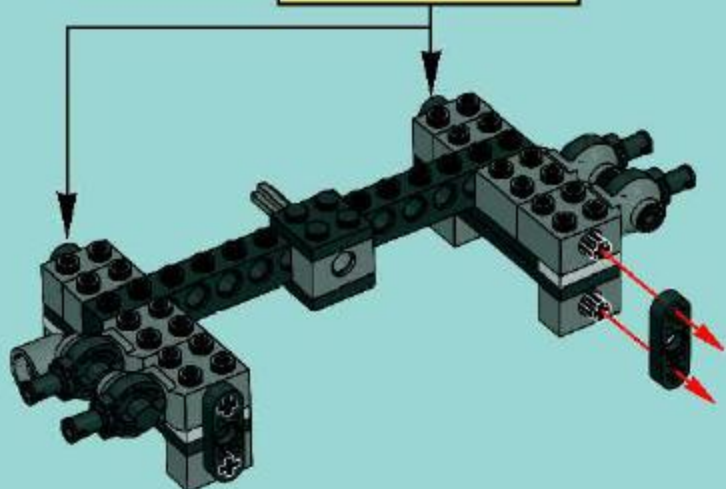
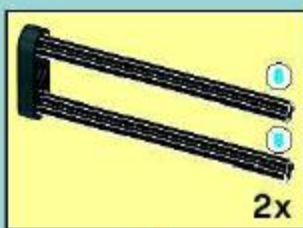

9

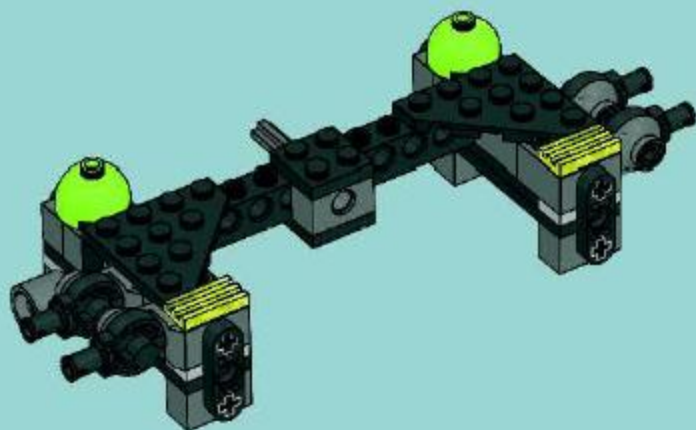



1



2





3



4

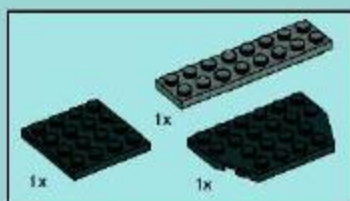
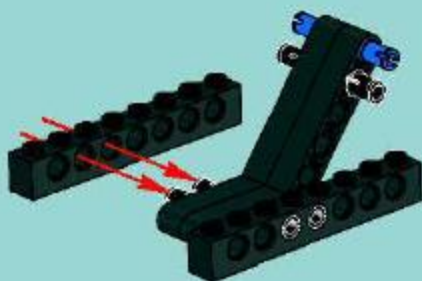

5





6



7

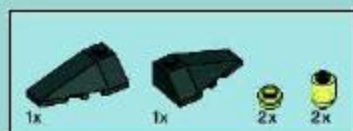
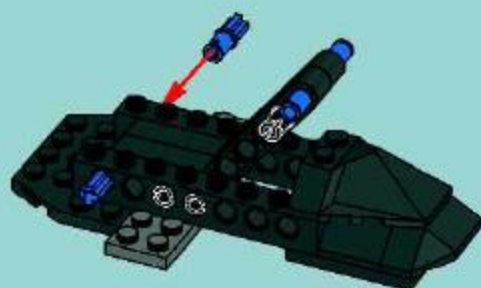

8





9



10



11



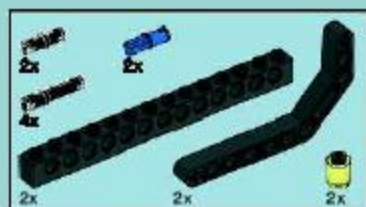

12

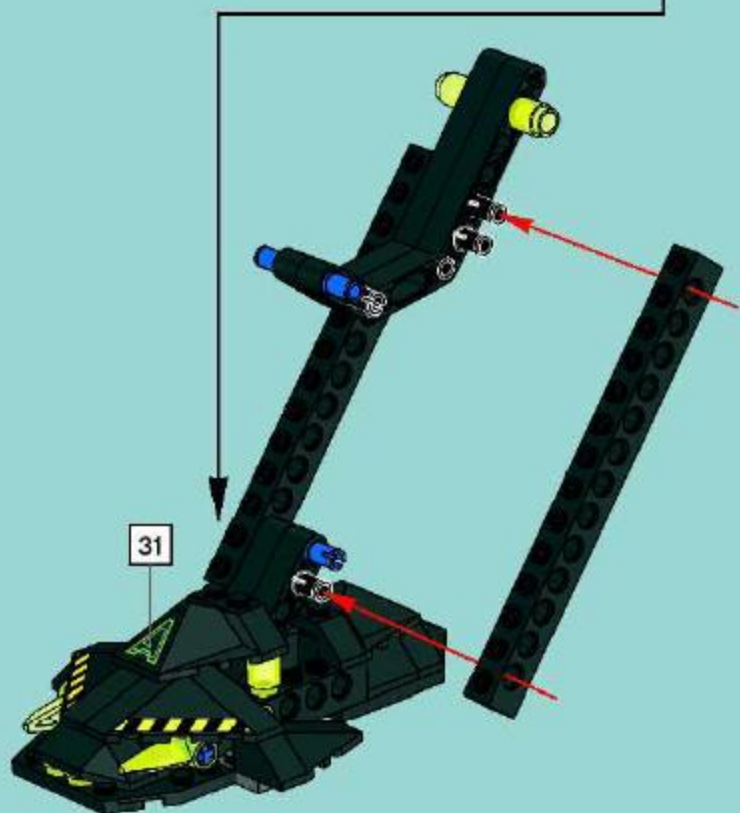
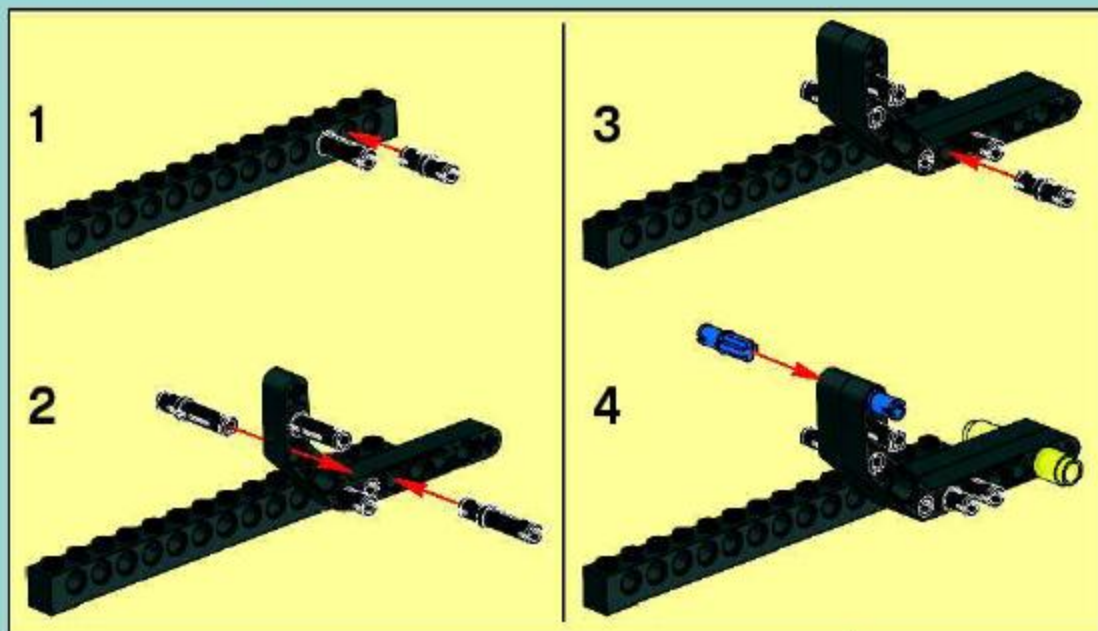



13

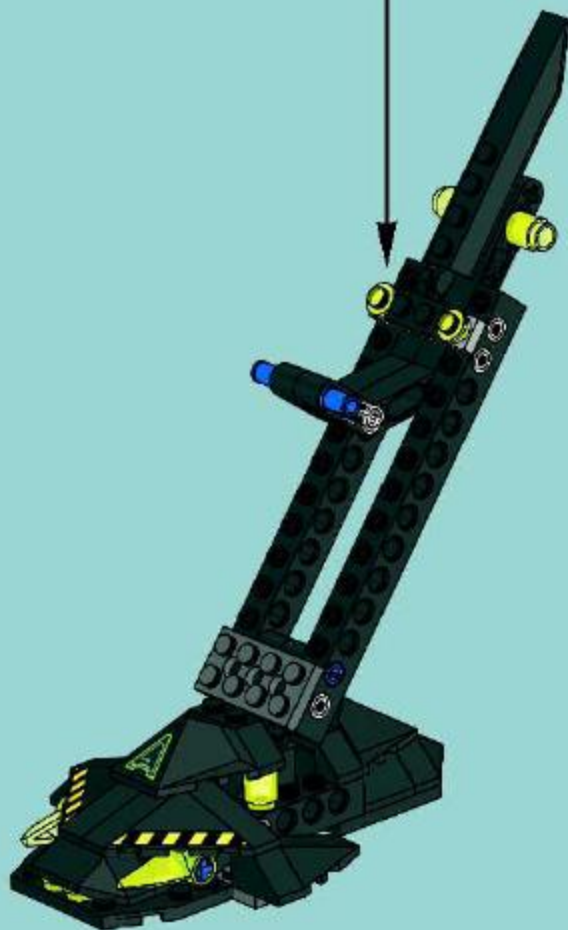
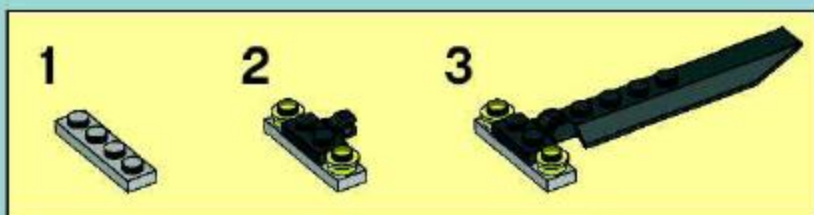



14

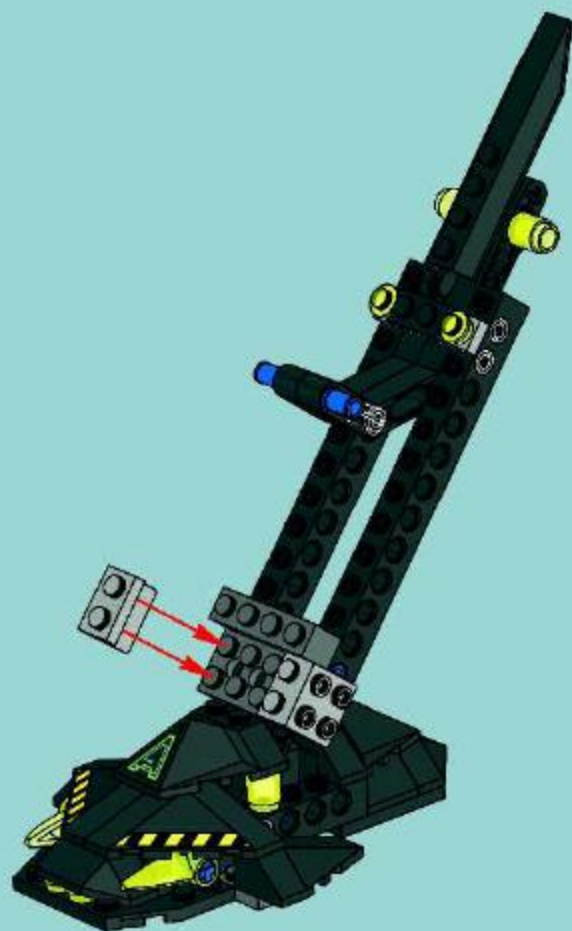



15

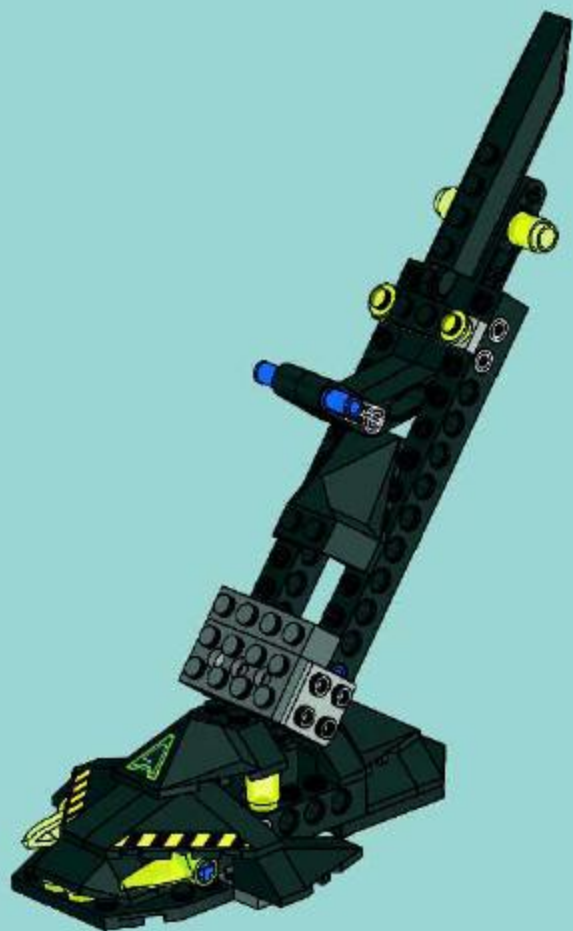

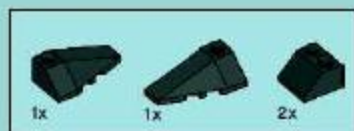

16

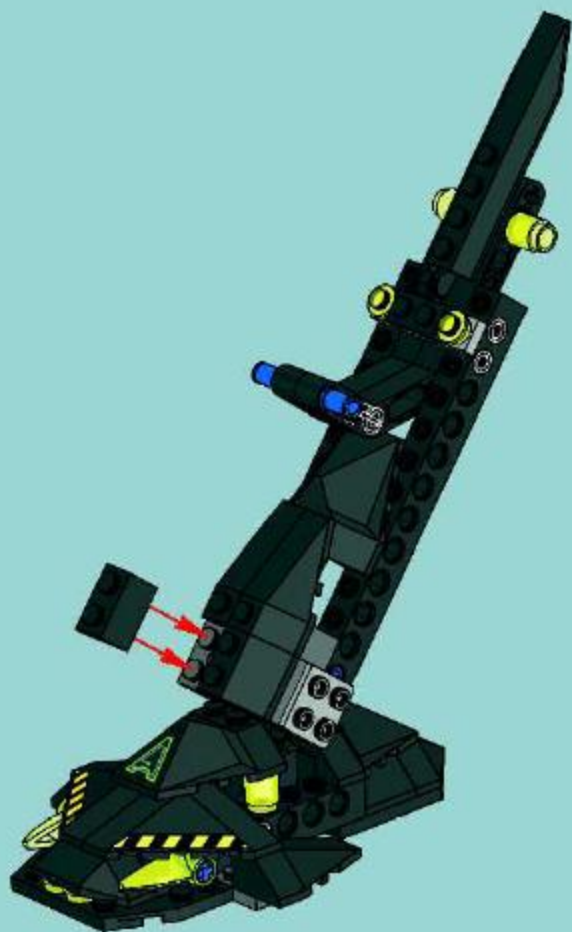



17

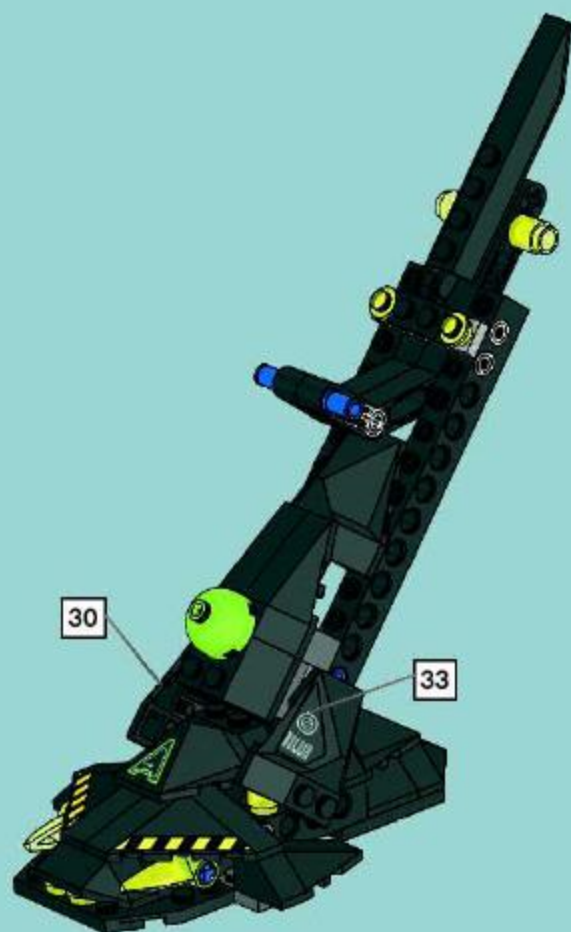

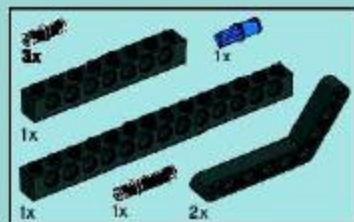

18

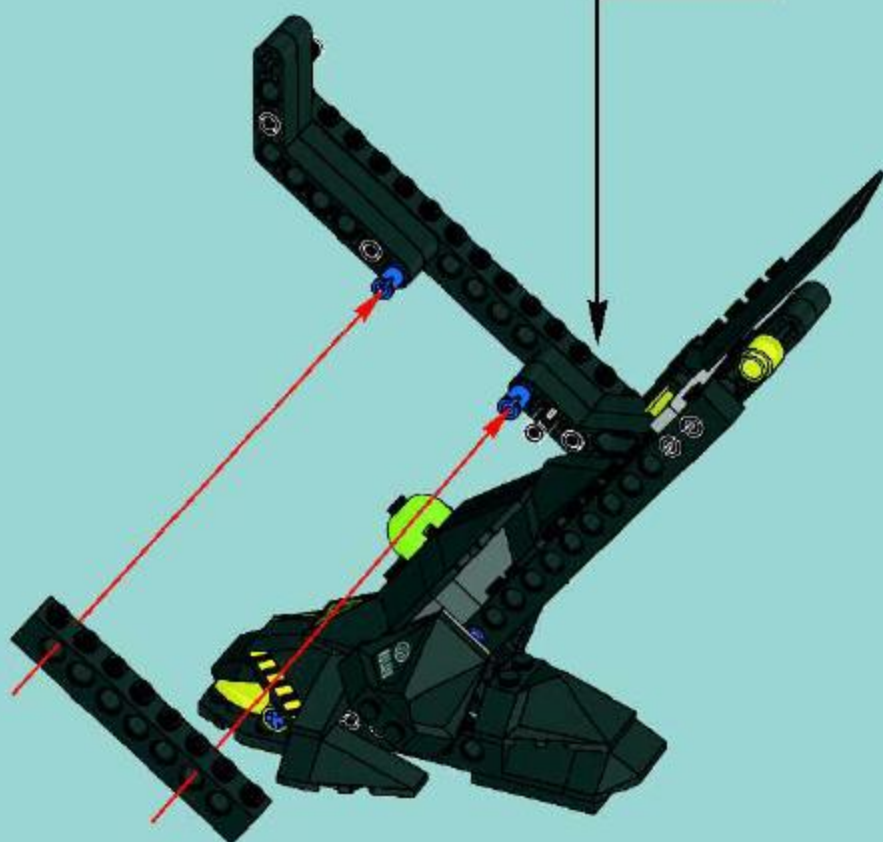
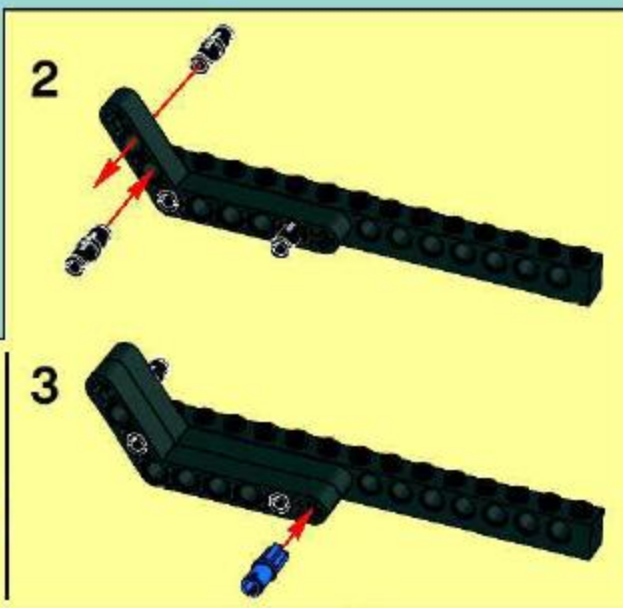



19

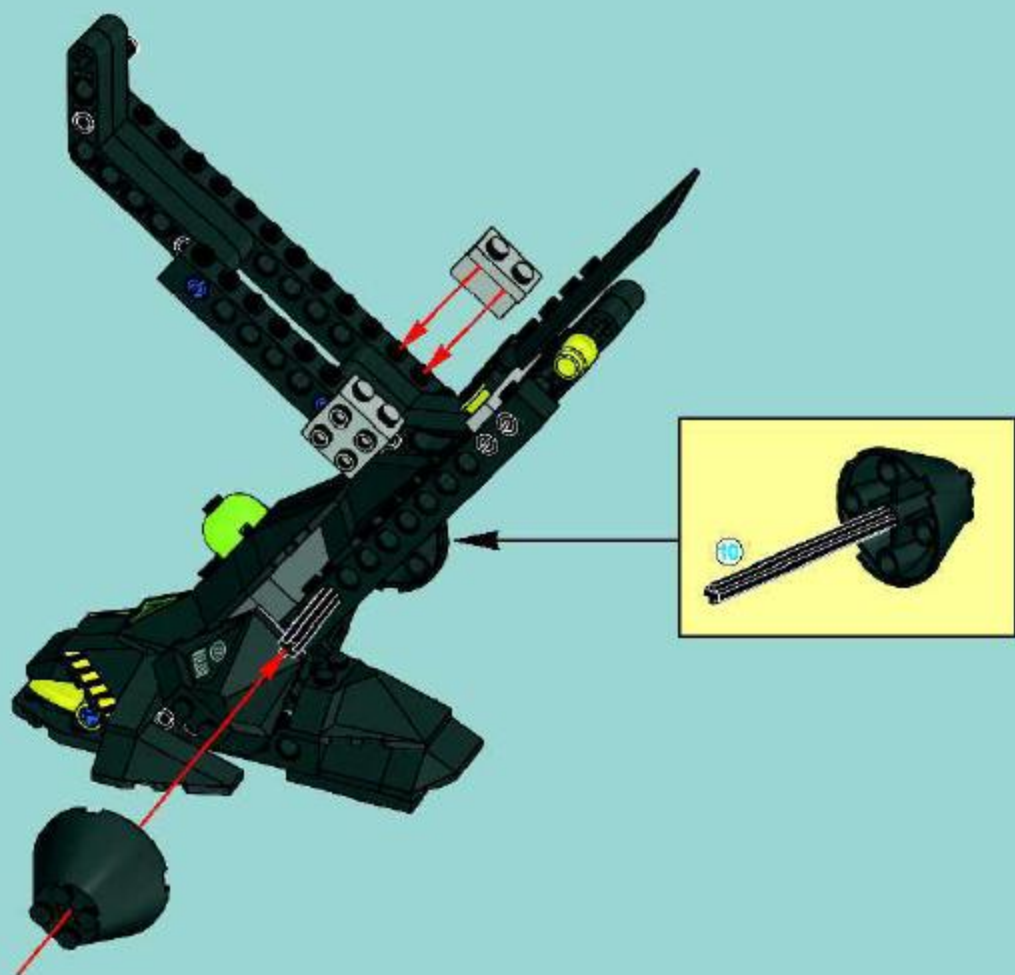

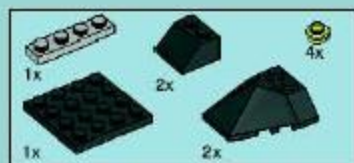

20

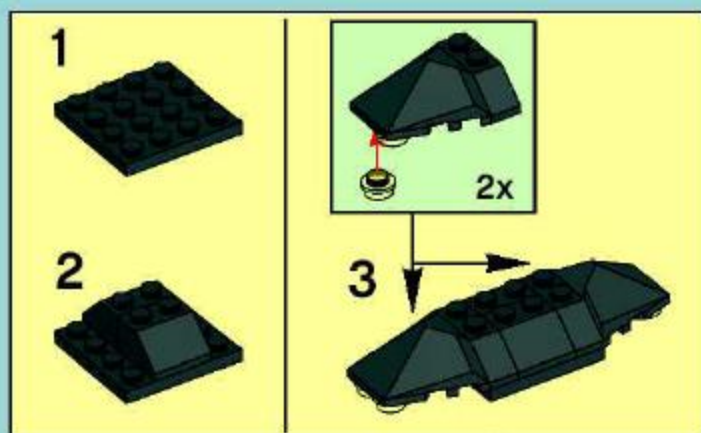



21

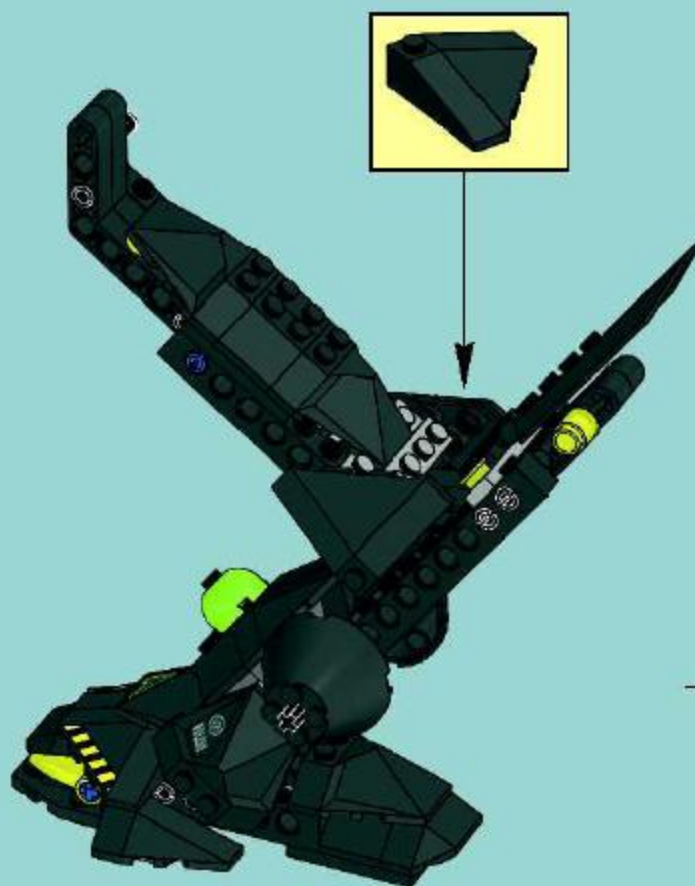

10



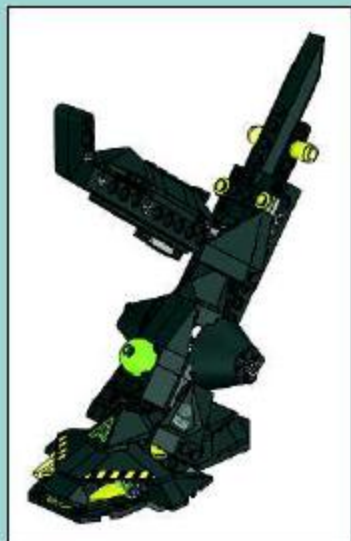

1



2





3



4

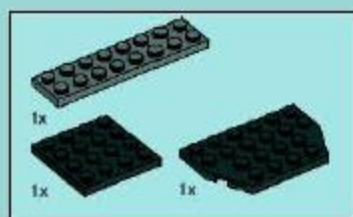
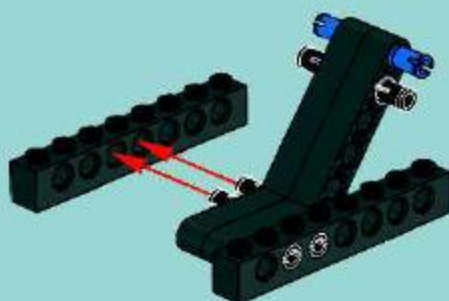

5

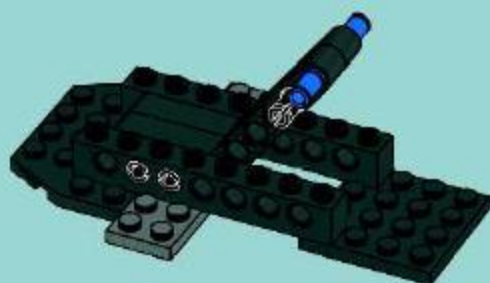



6

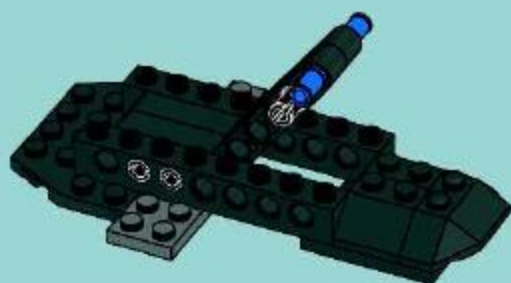

7

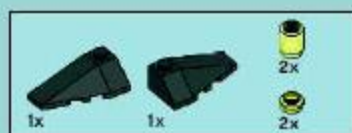
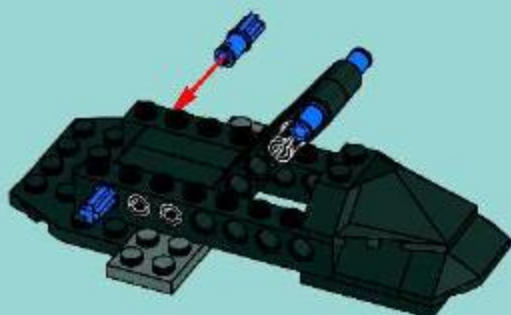

8





9



10



11





12

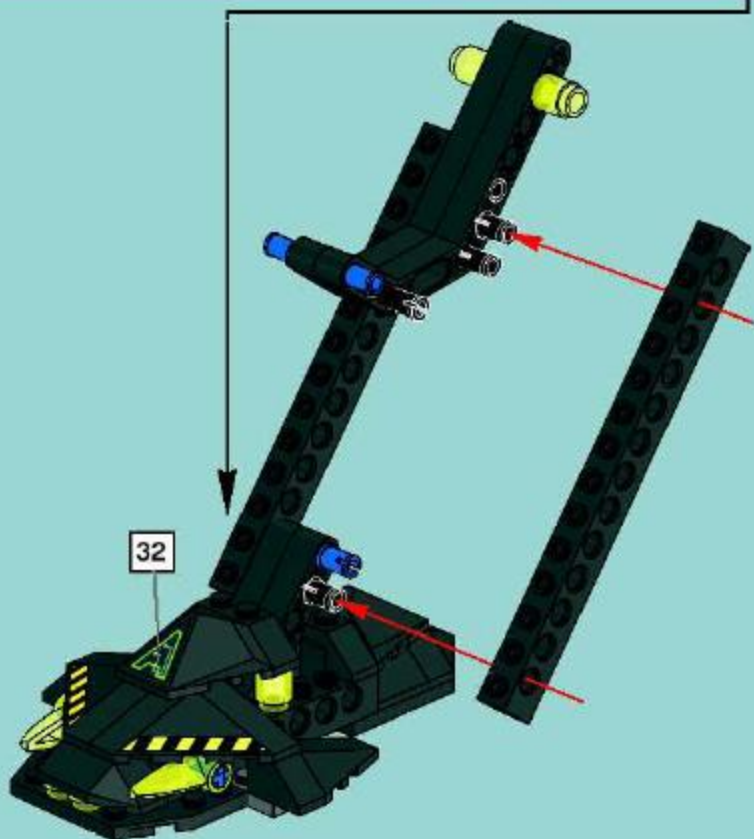
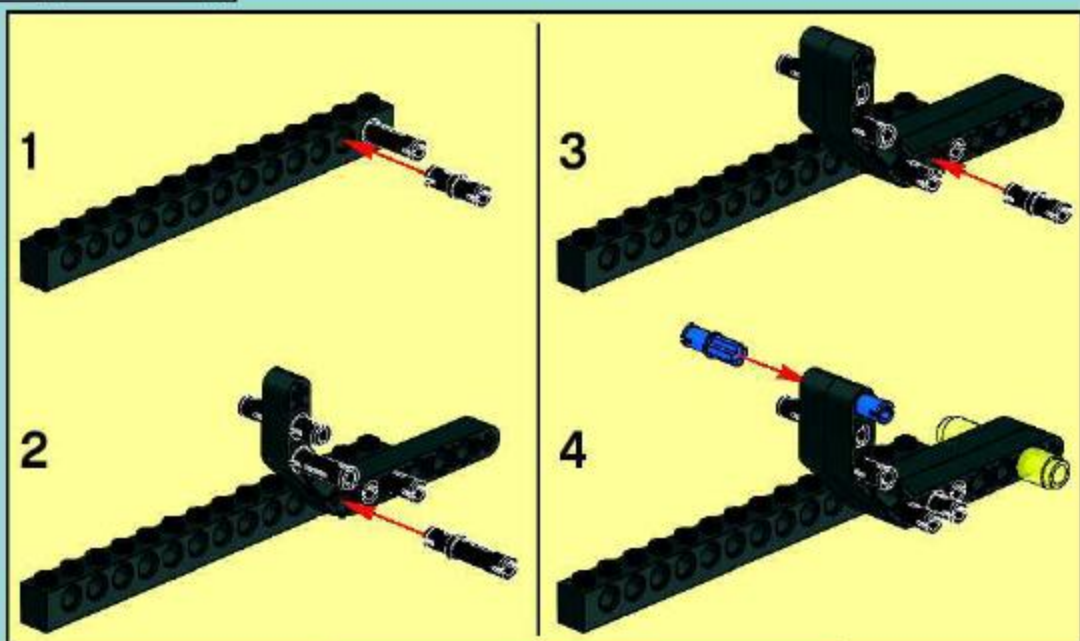



13

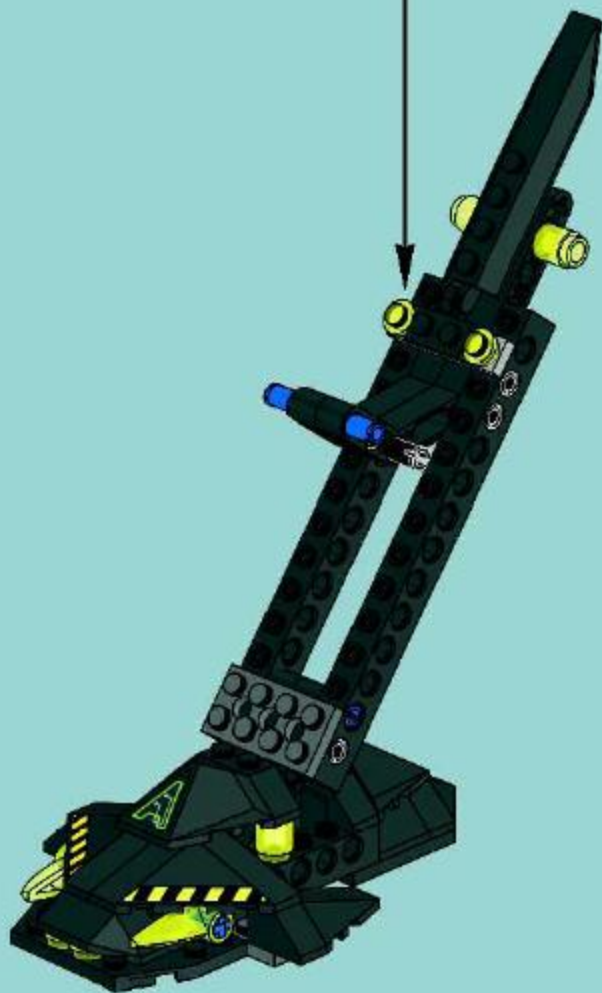



14

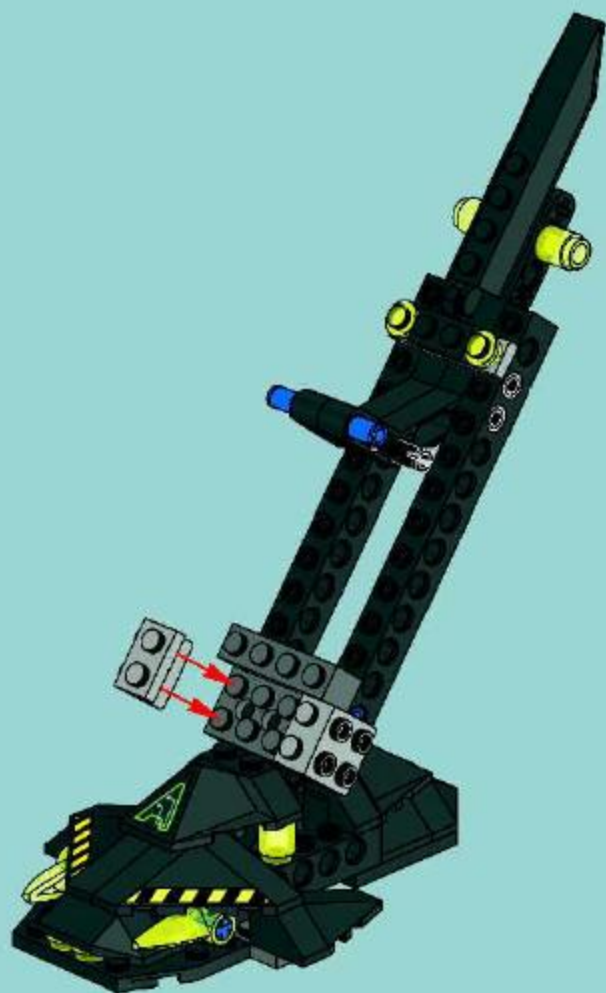



15

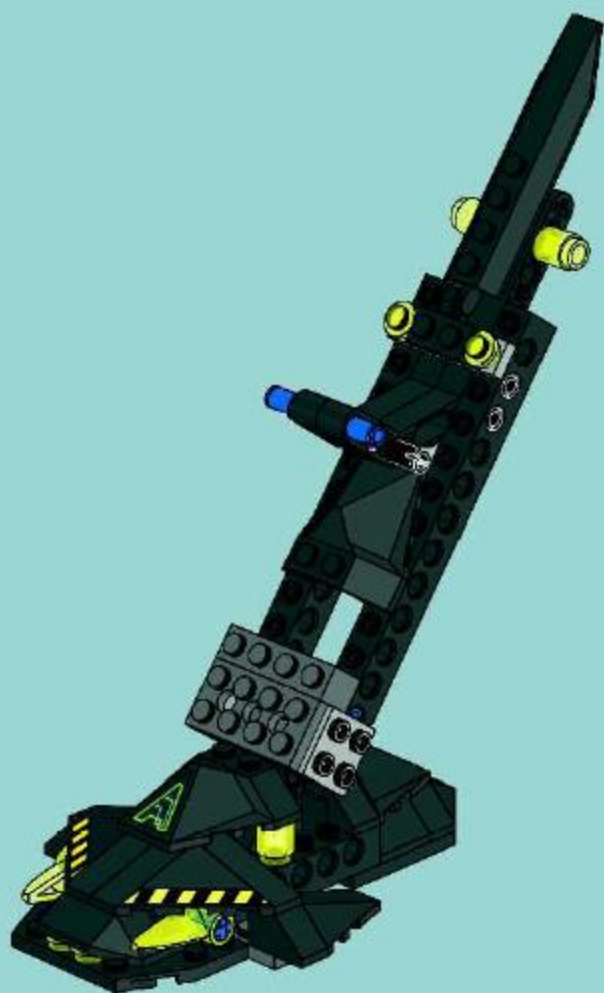



16

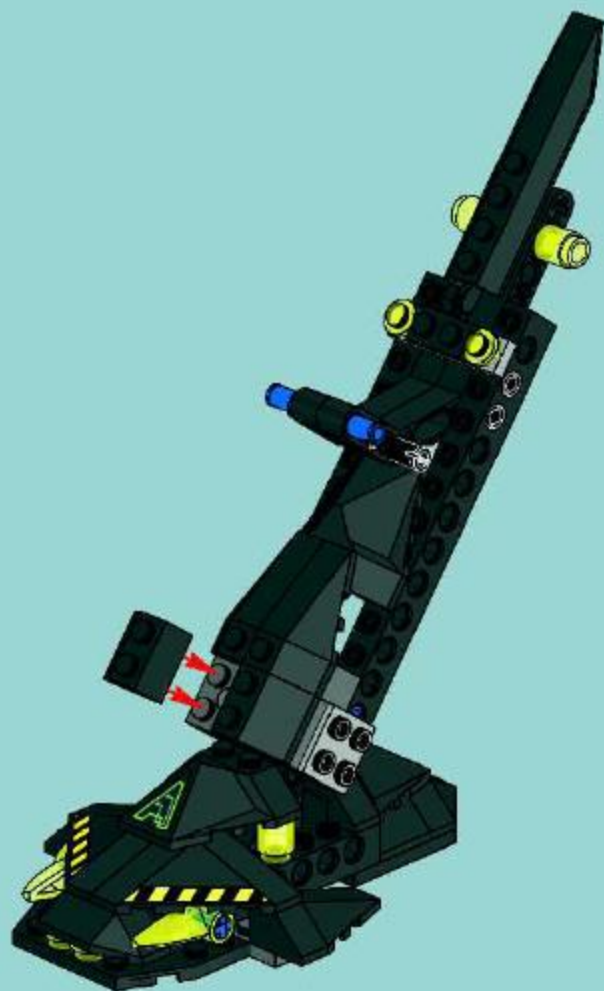



17

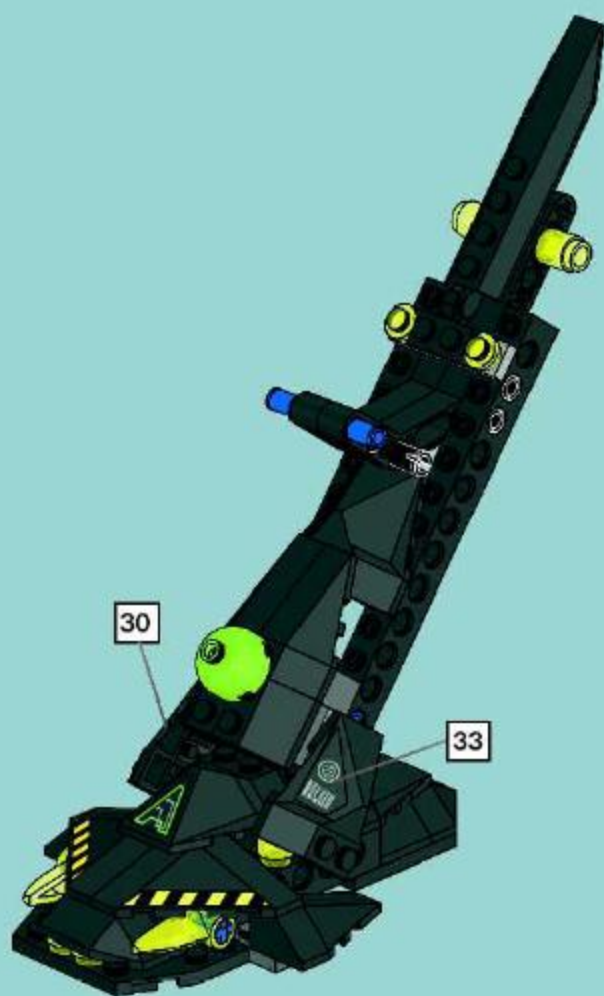

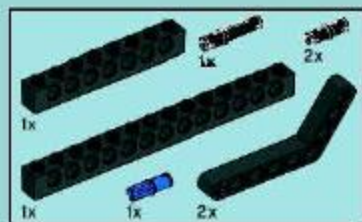

18

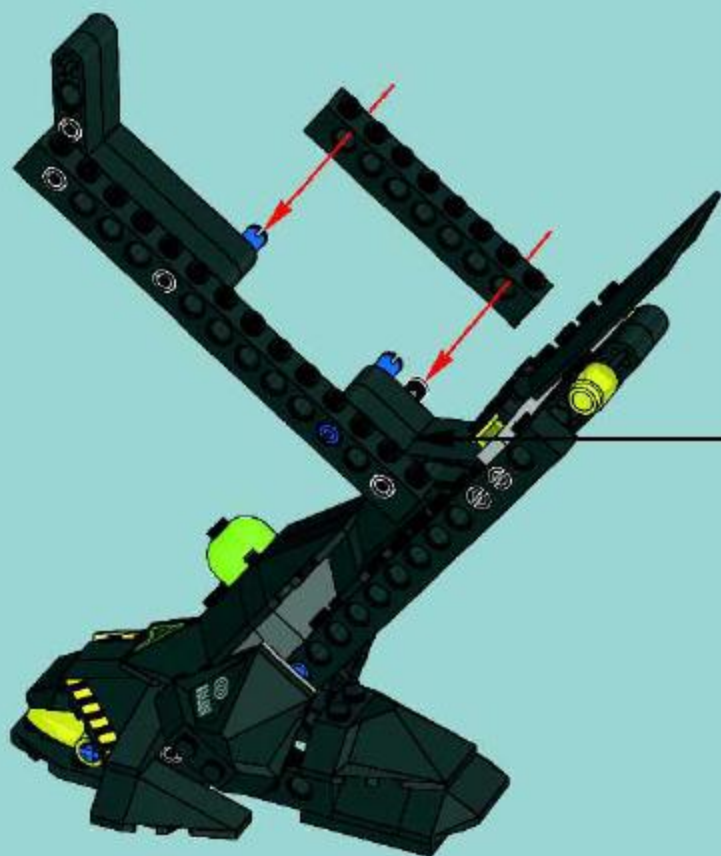
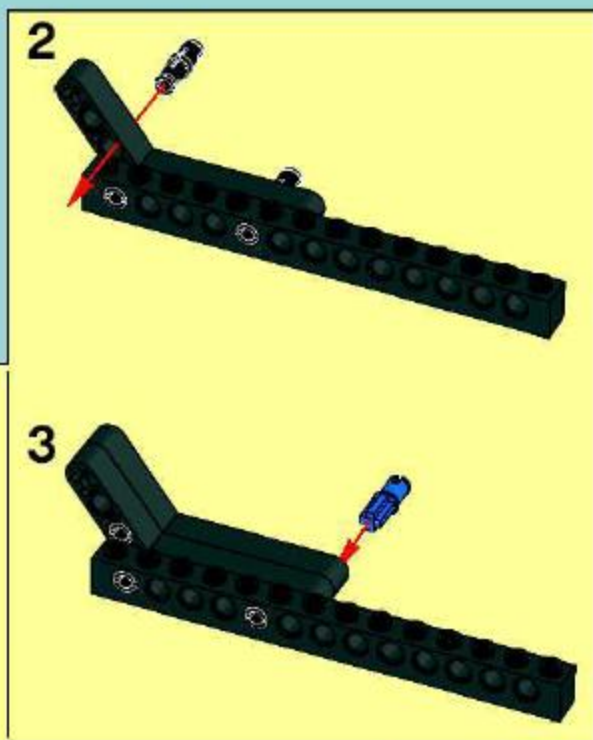
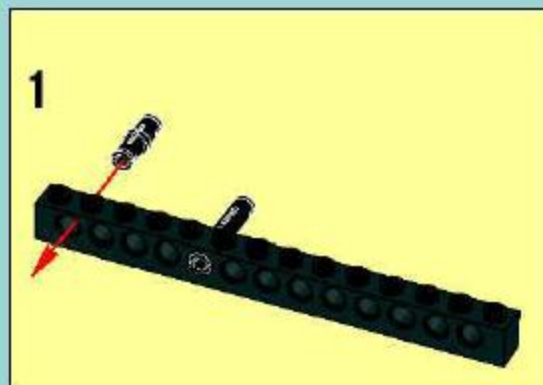

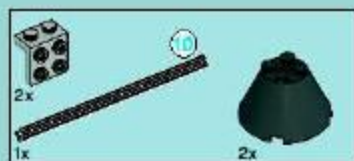

19

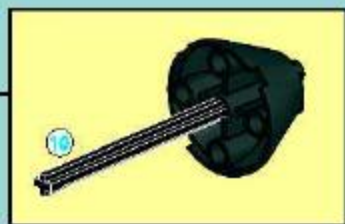
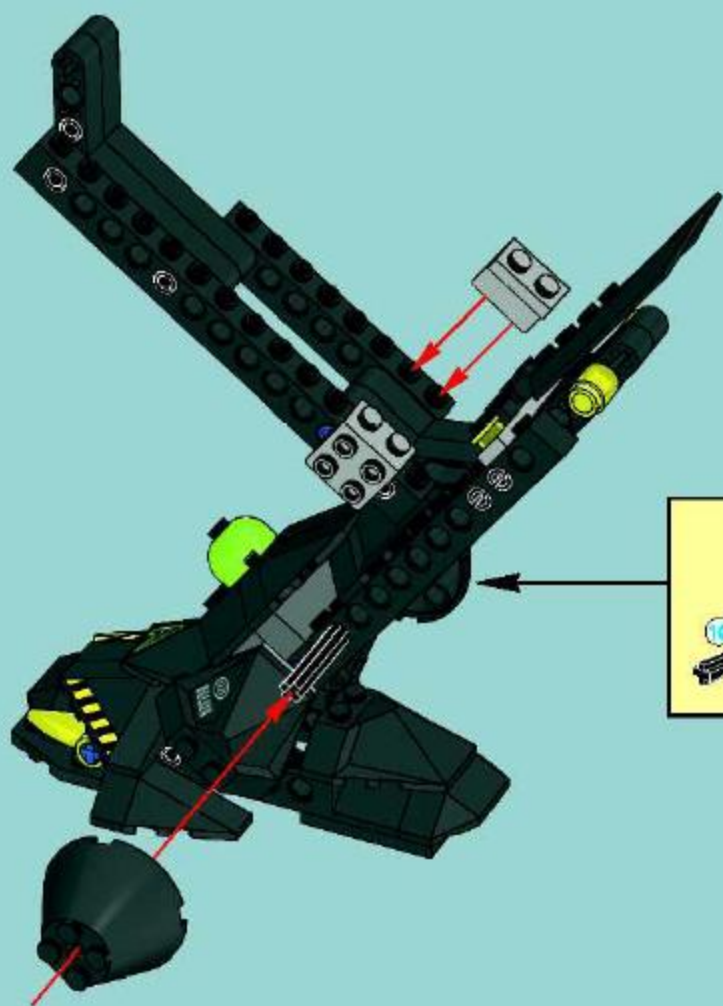

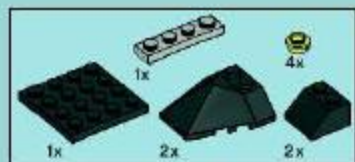

20

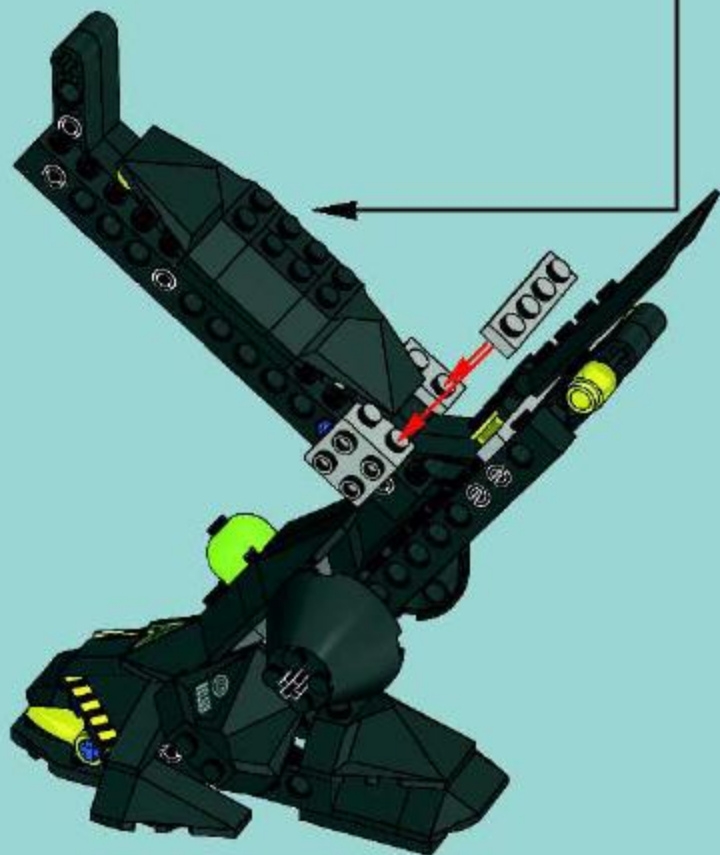
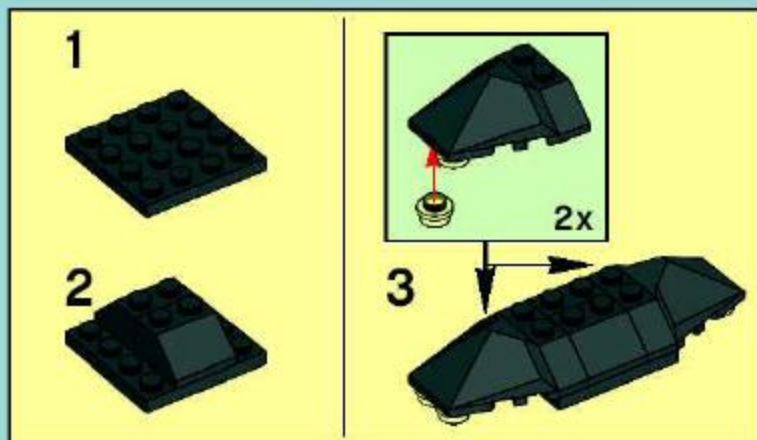



2x

21

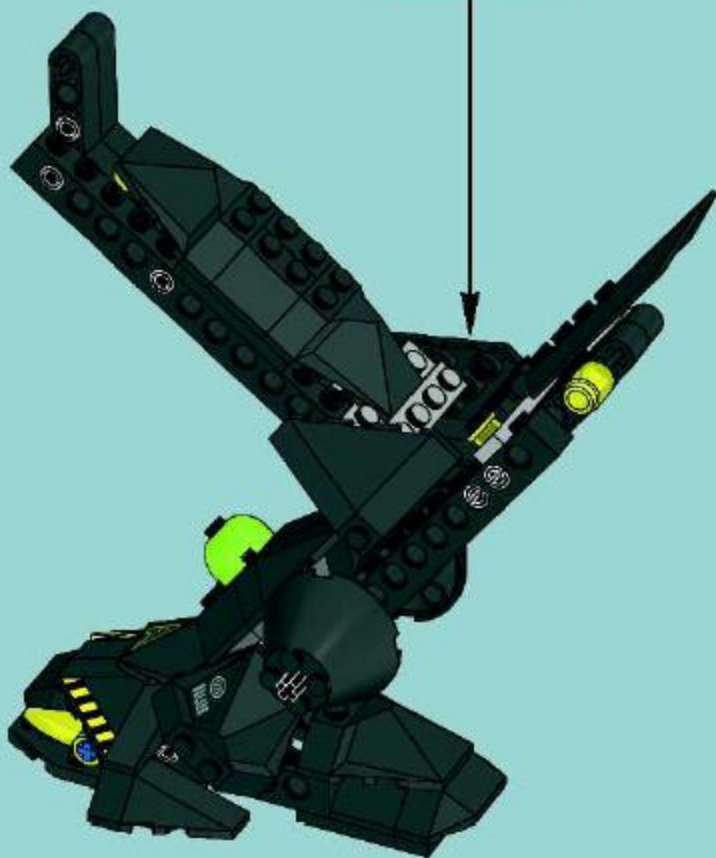

11

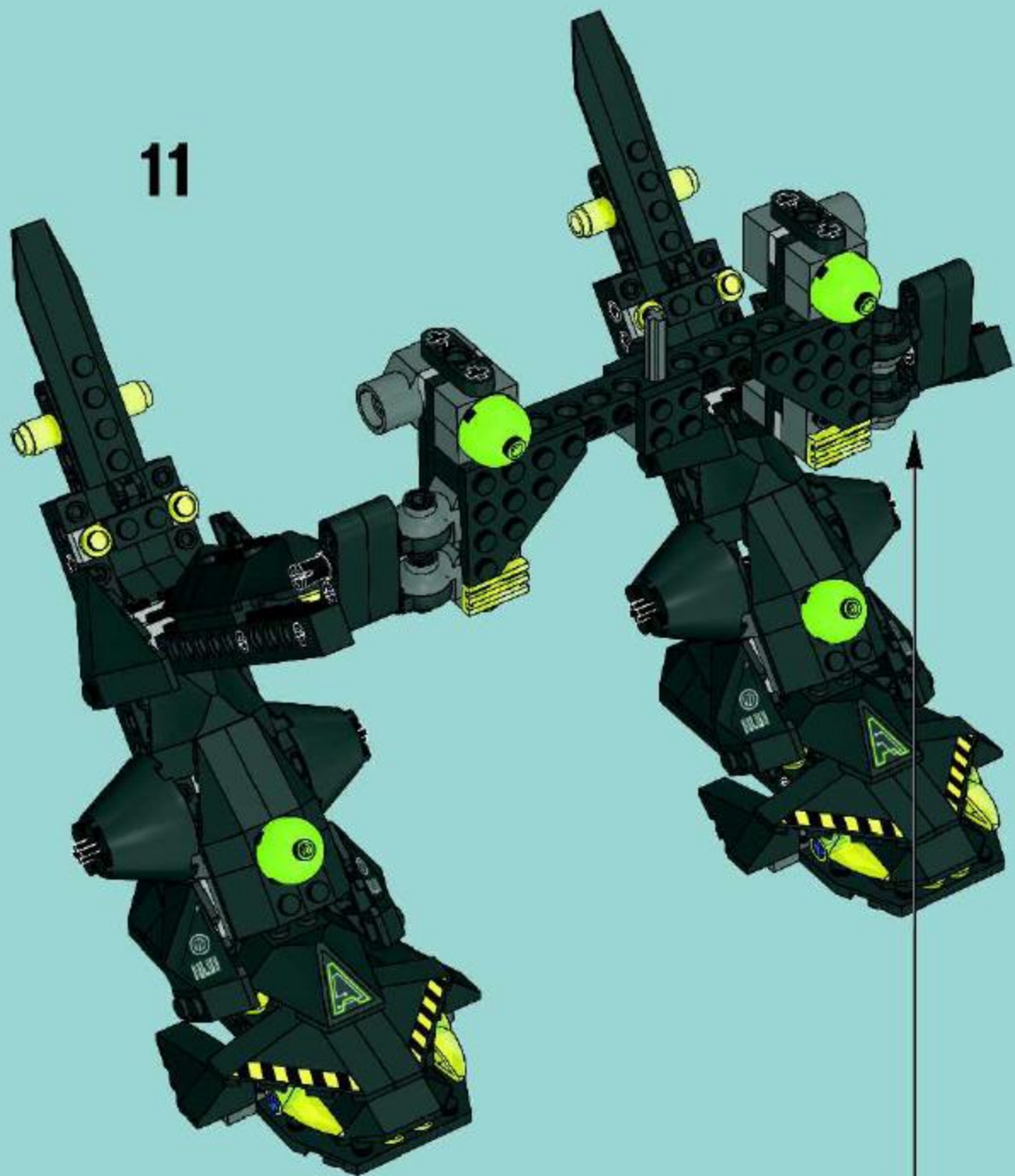

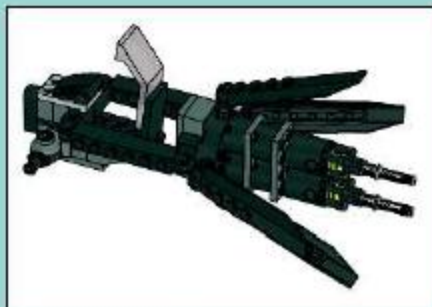

1



2

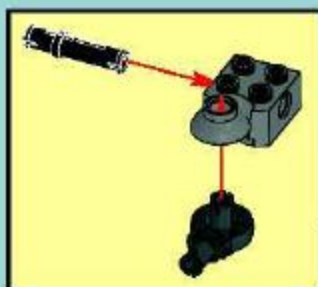



3

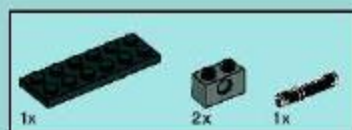

4

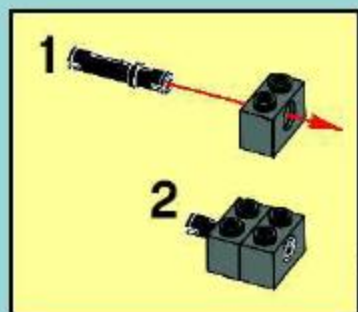

5

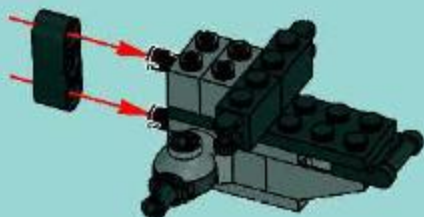



6

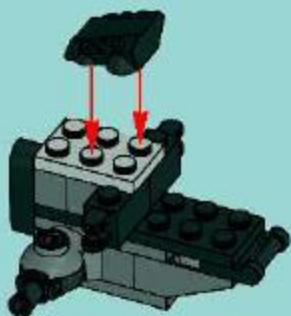

7

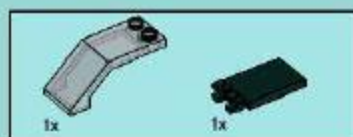
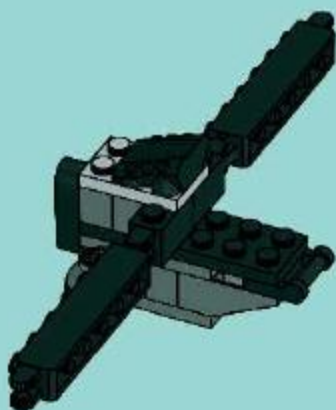

8

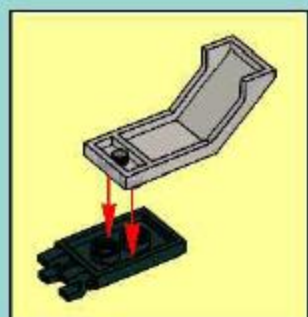
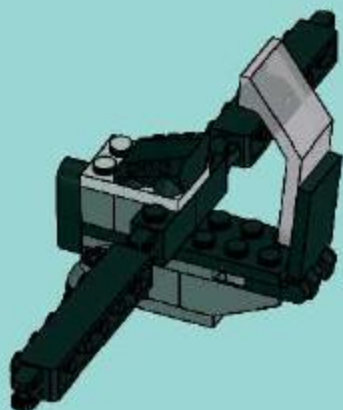



1



2



3





4x

4



1x



2x

5

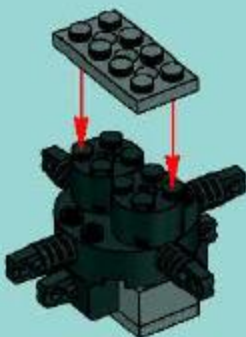

4

2x

6



1:1



7



8

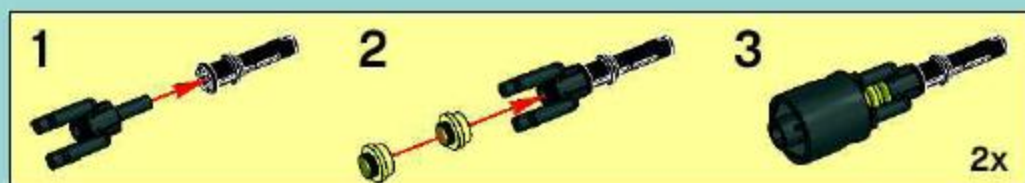

9

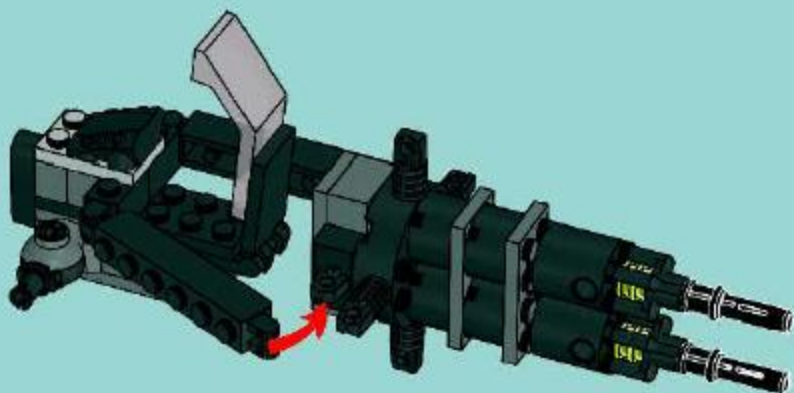

10

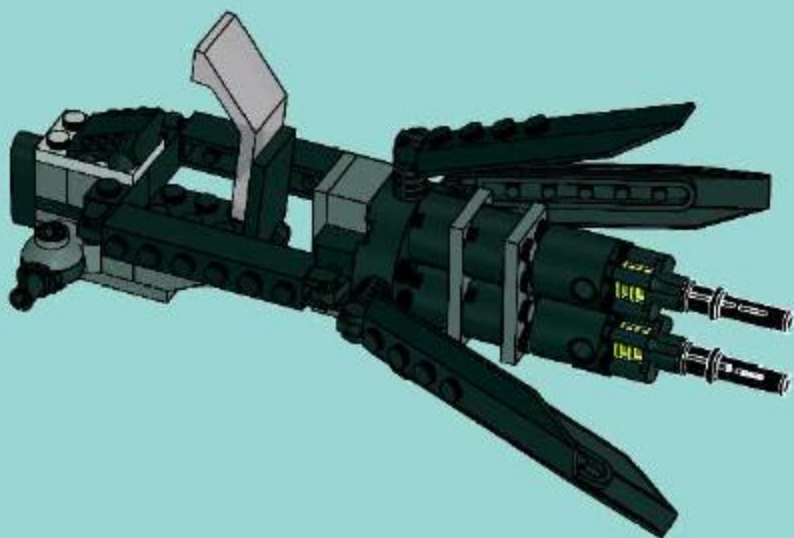

11

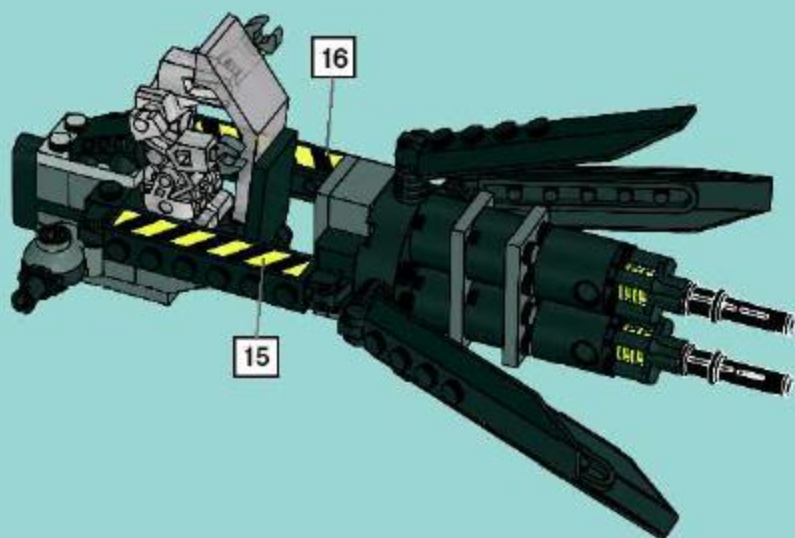

12



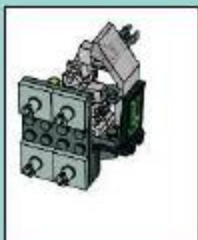

1



2

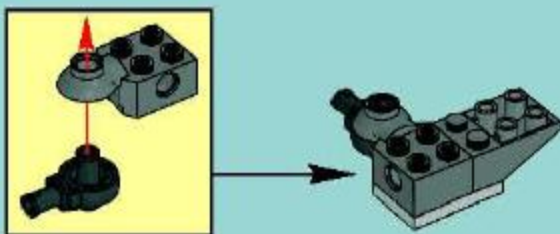



3



4



5



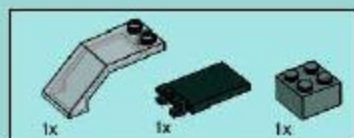

6

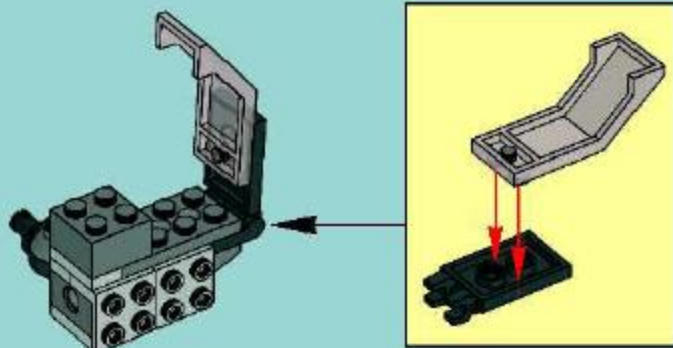

7



8

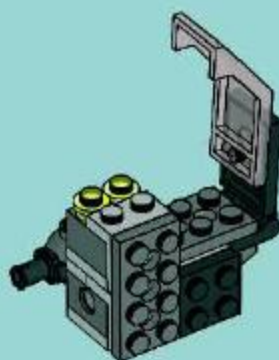



9



10

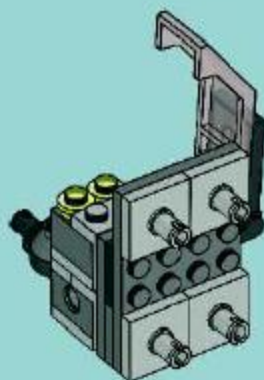

11

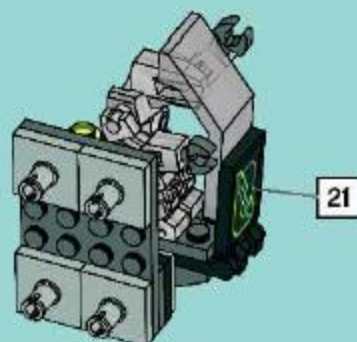

13

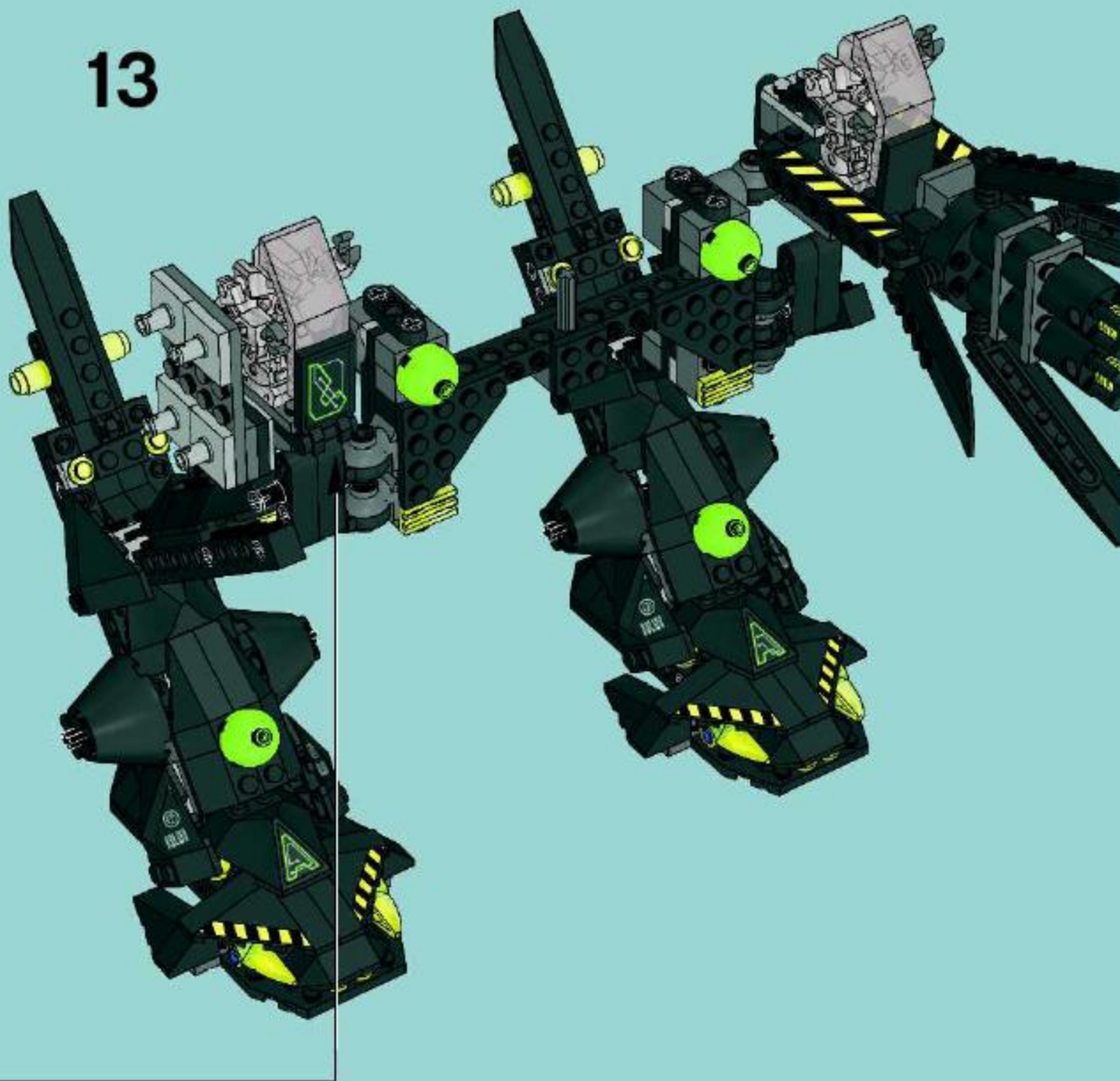



1



2



3





4

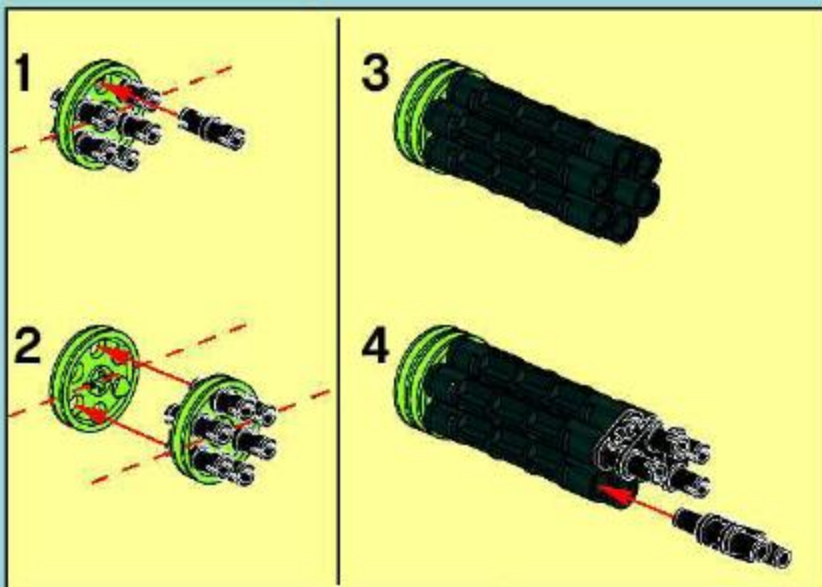
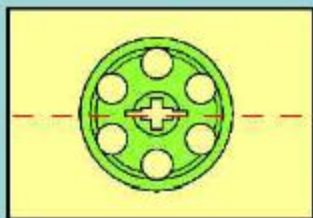

14

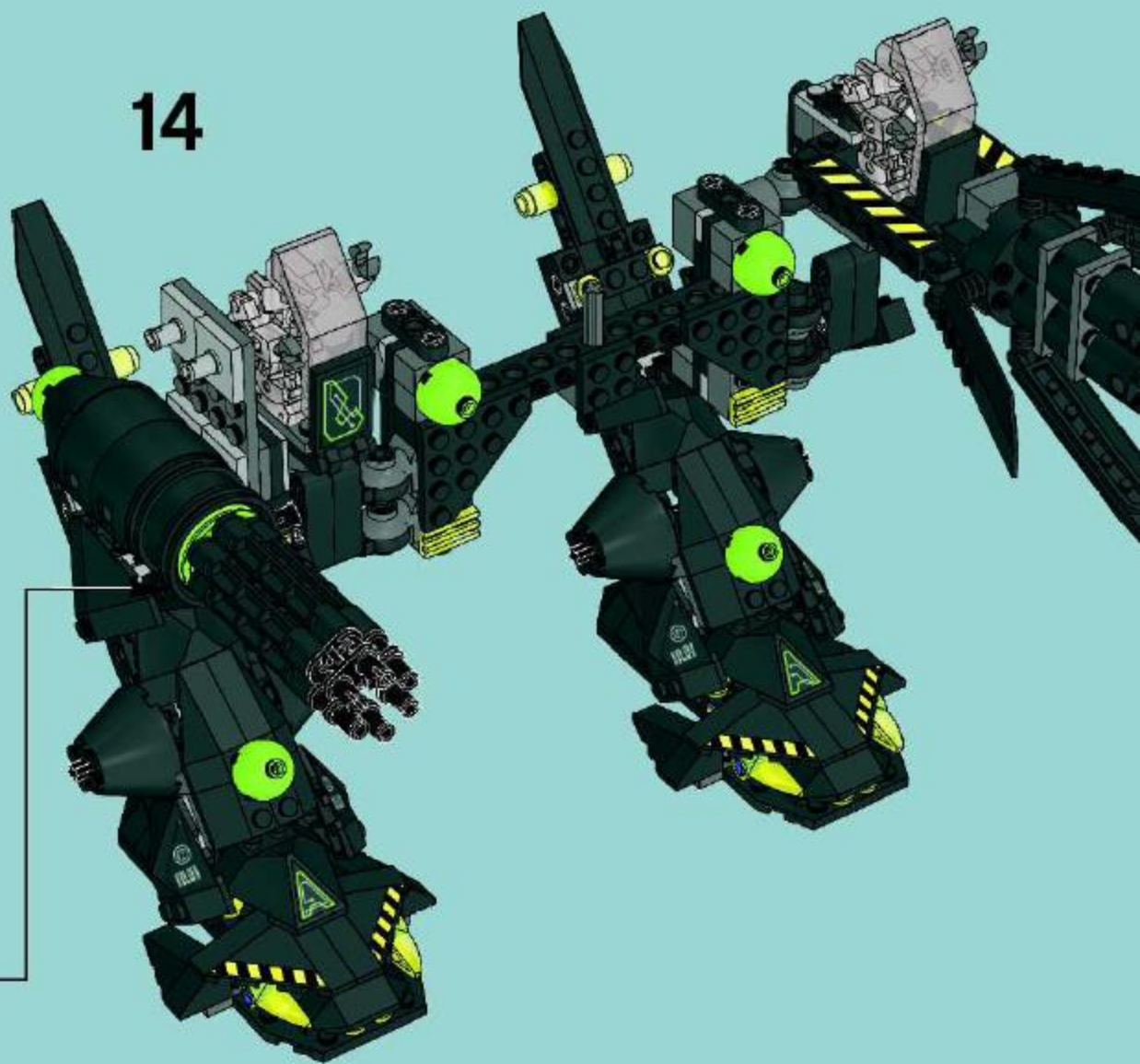

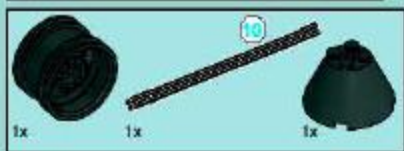

1

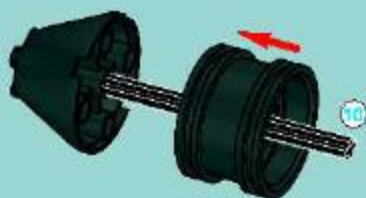

2



3



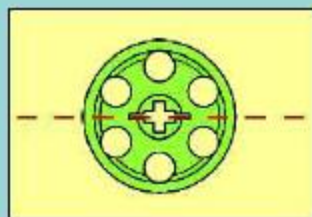

4

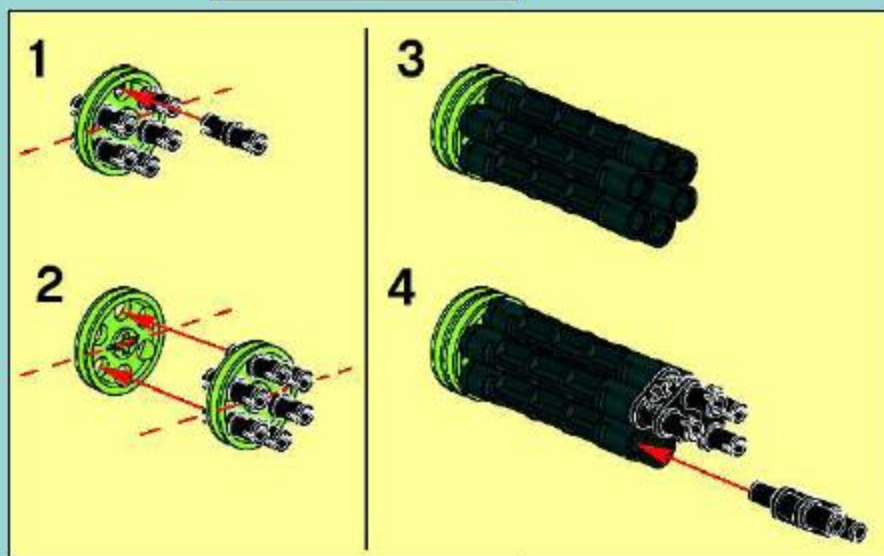

5





6



15

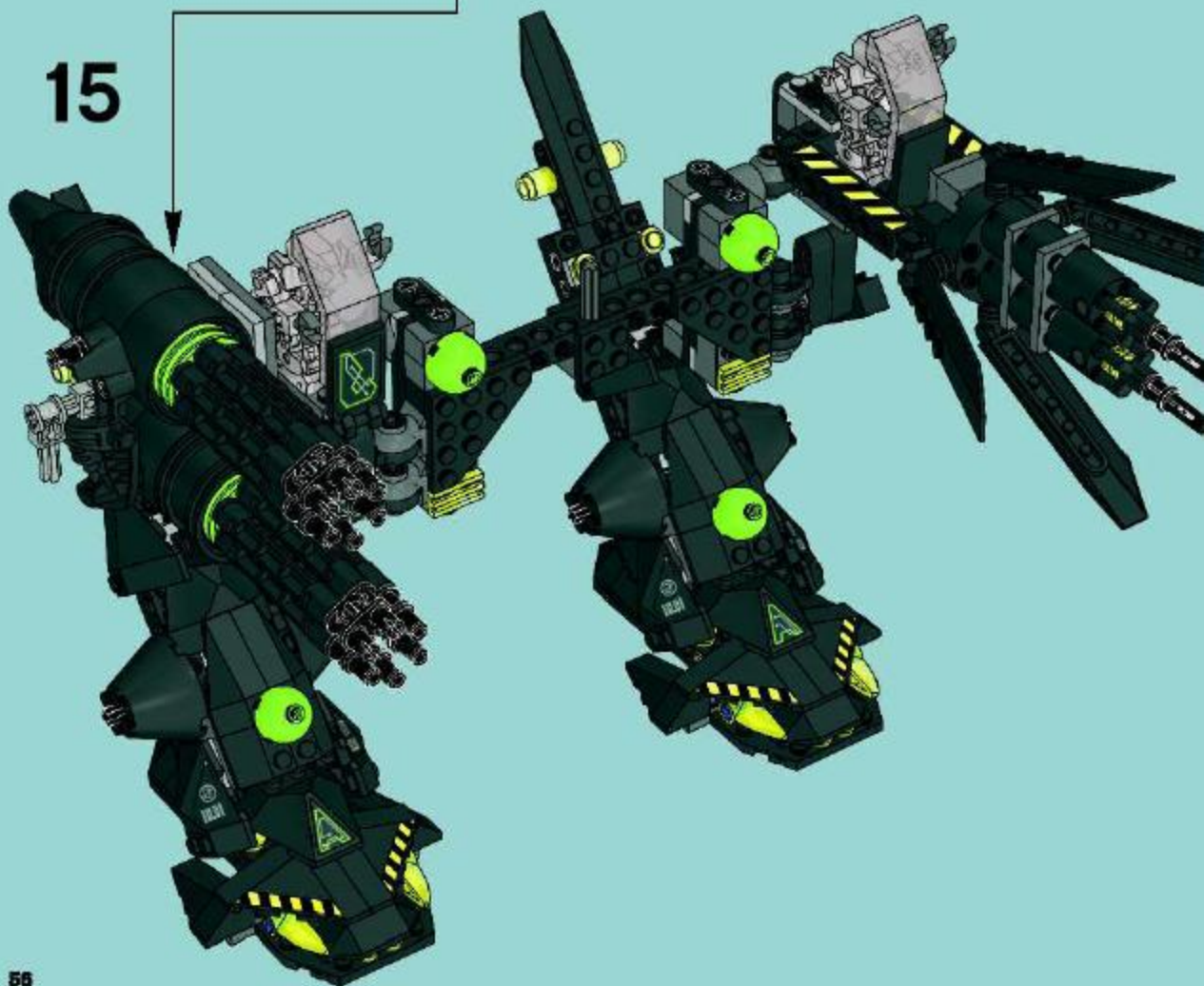



16

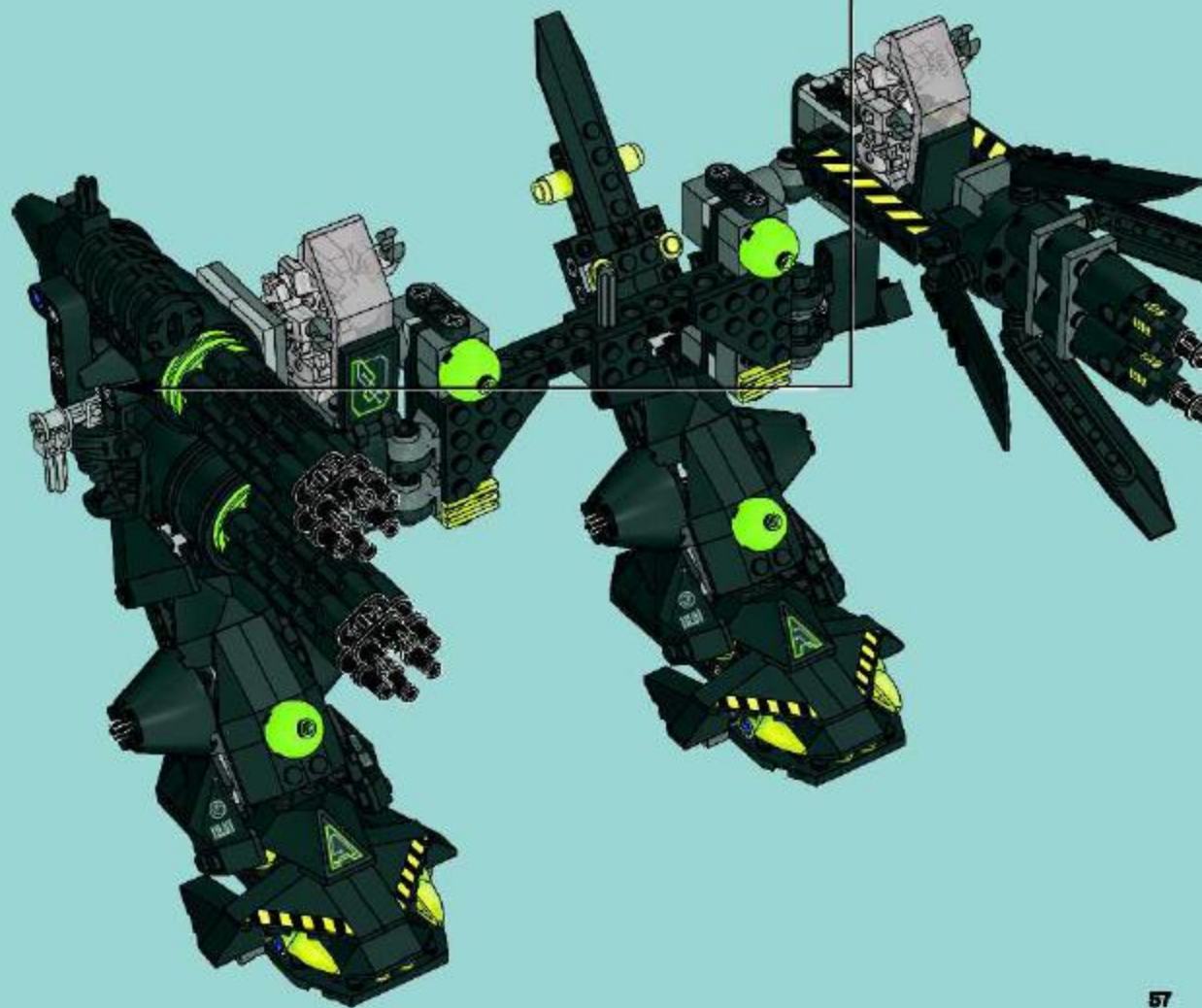
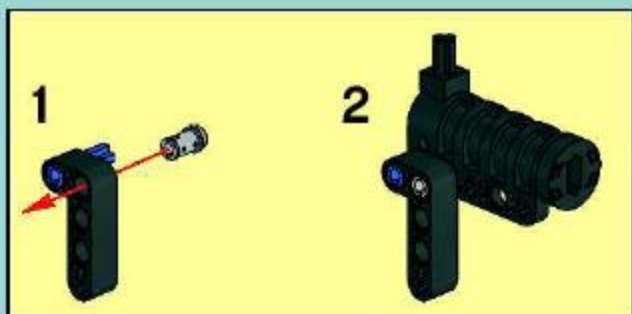

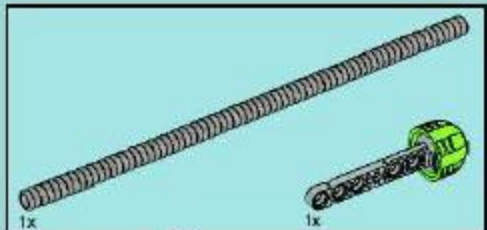

17

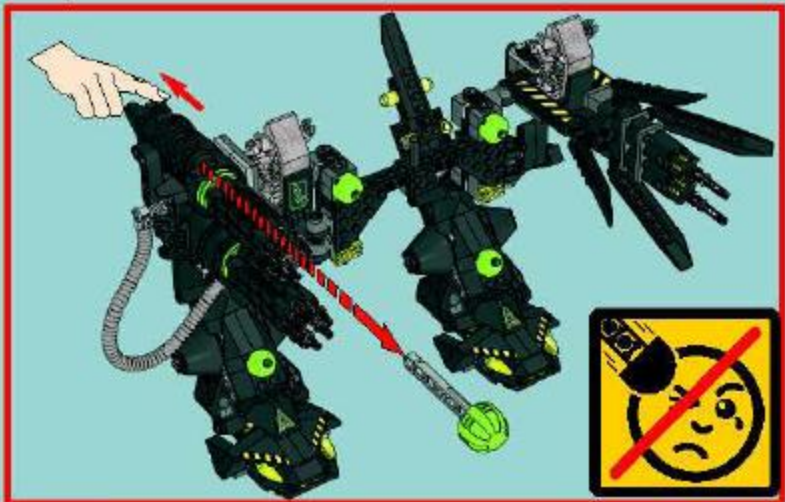
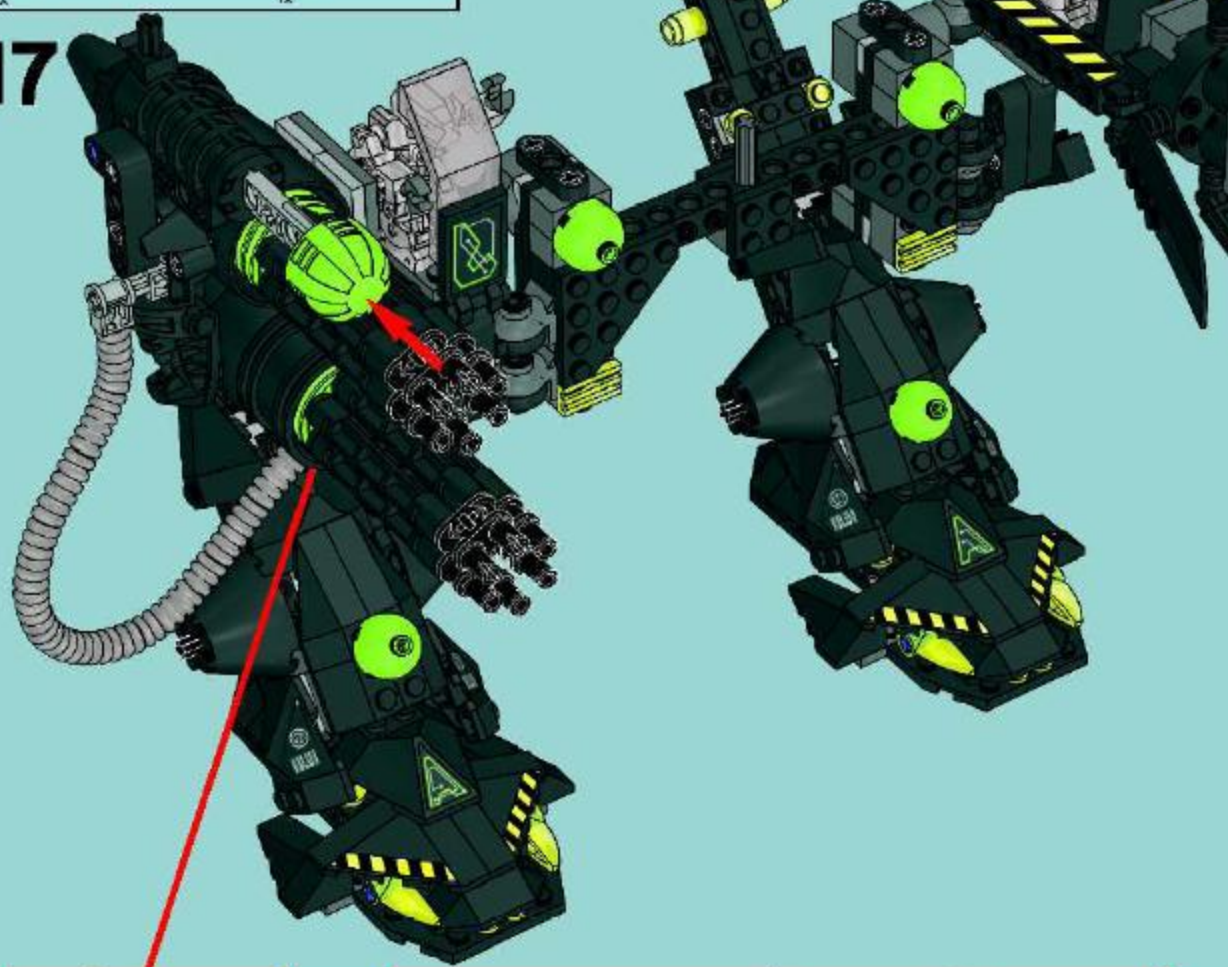



1

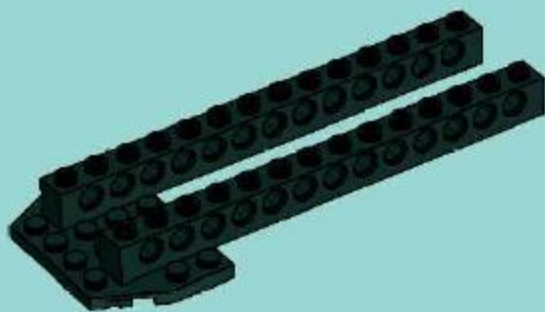

2

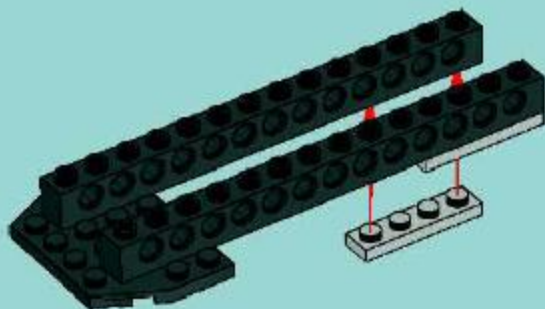

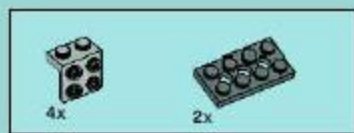

3

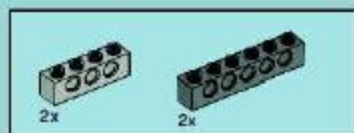
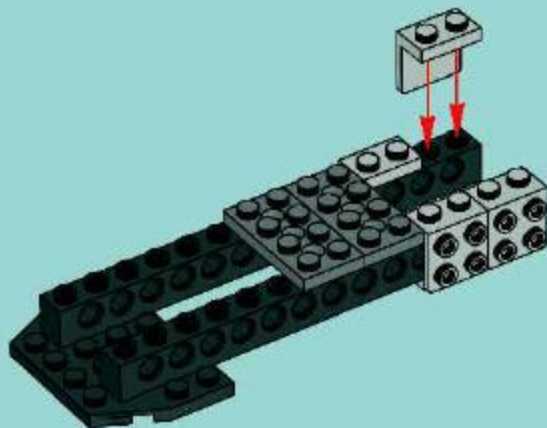

4

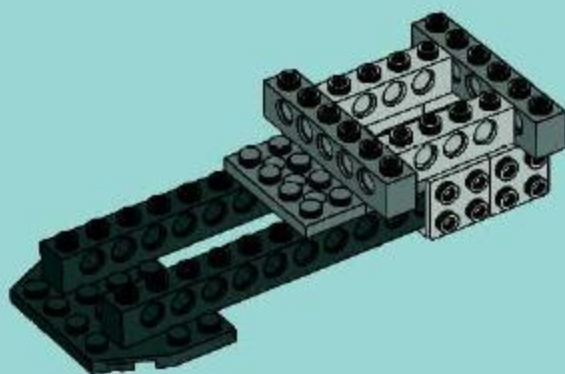

5

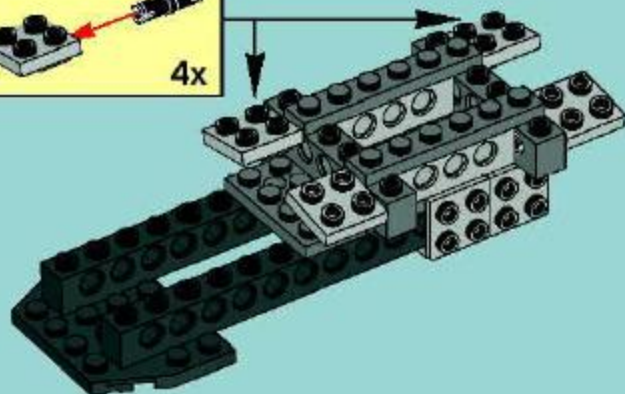
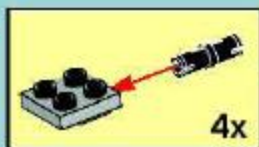



6

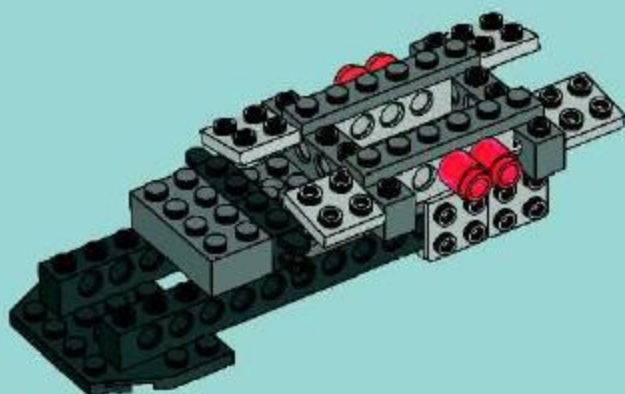

7

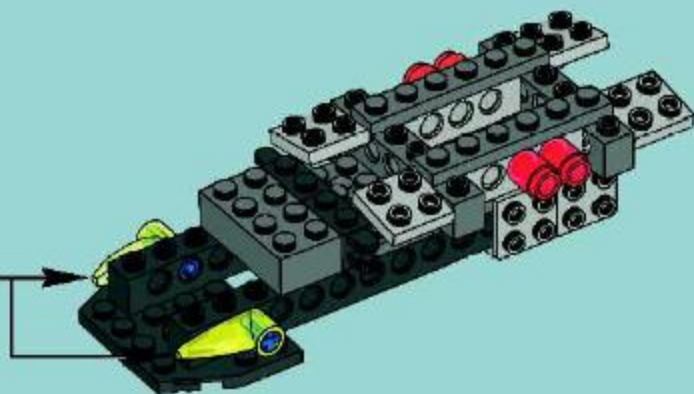
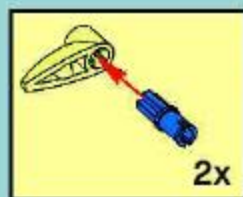



8

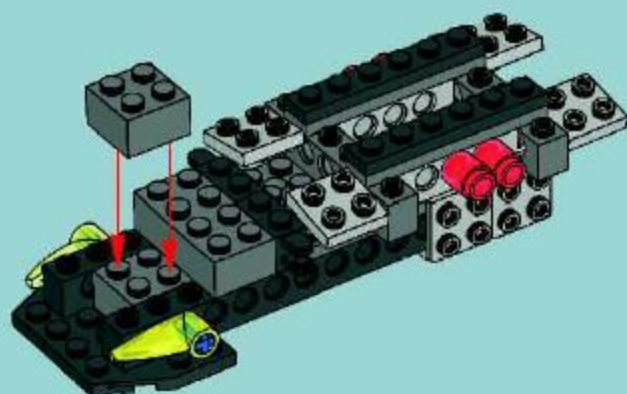

9

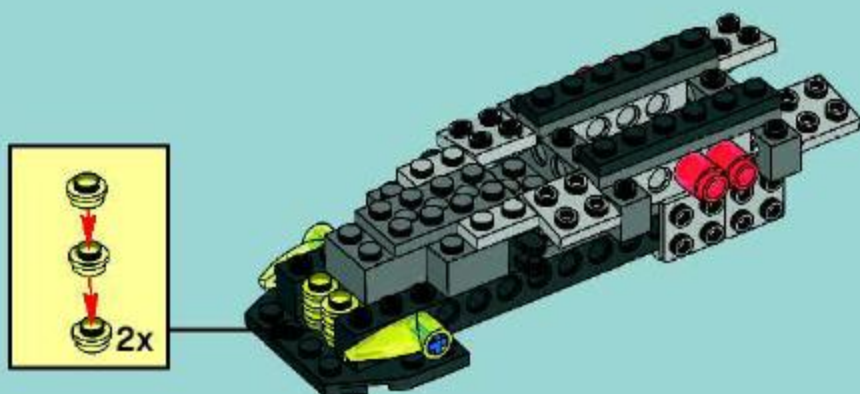



10

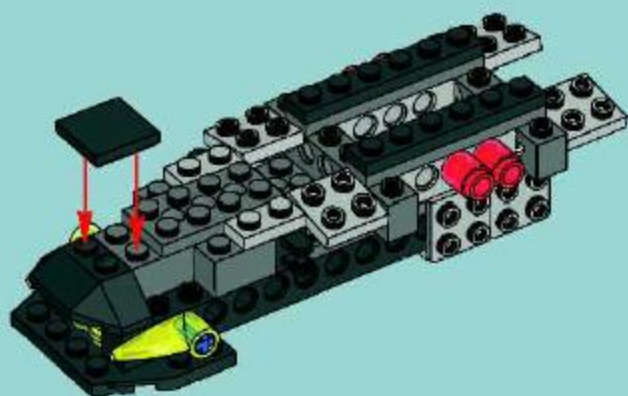

11

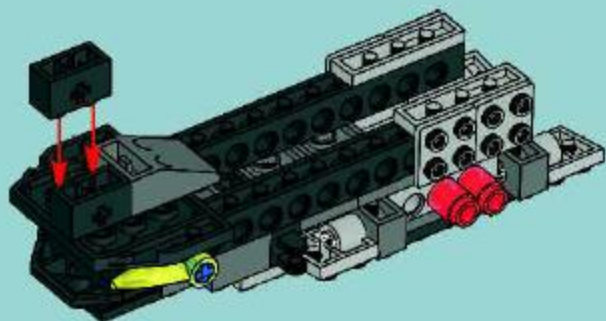



12

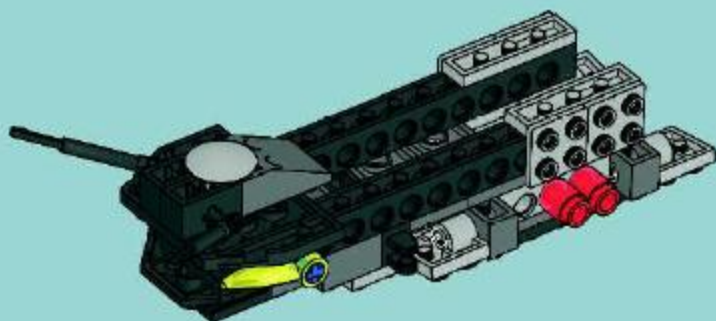

13

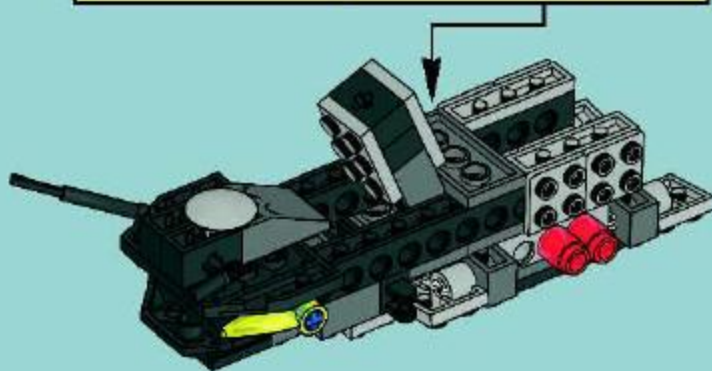
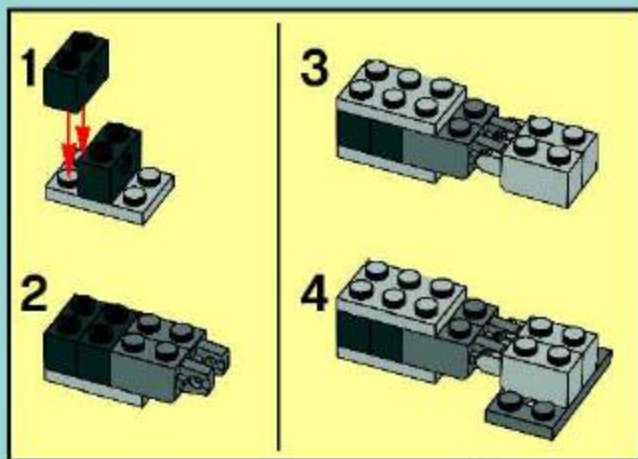

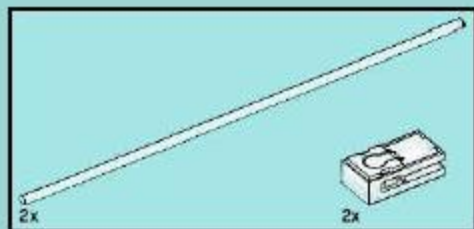

14

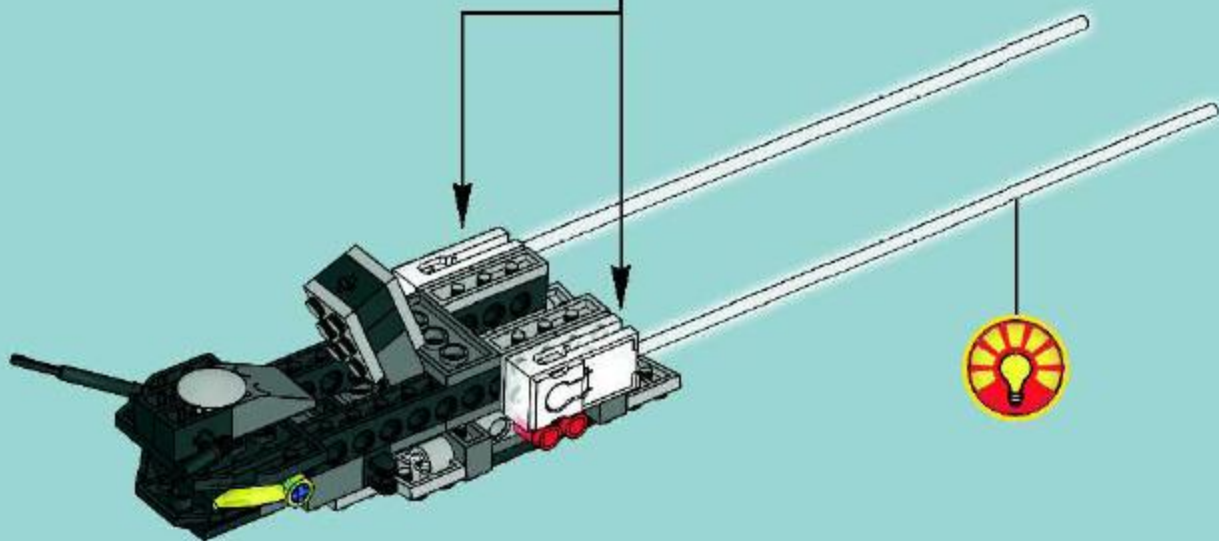
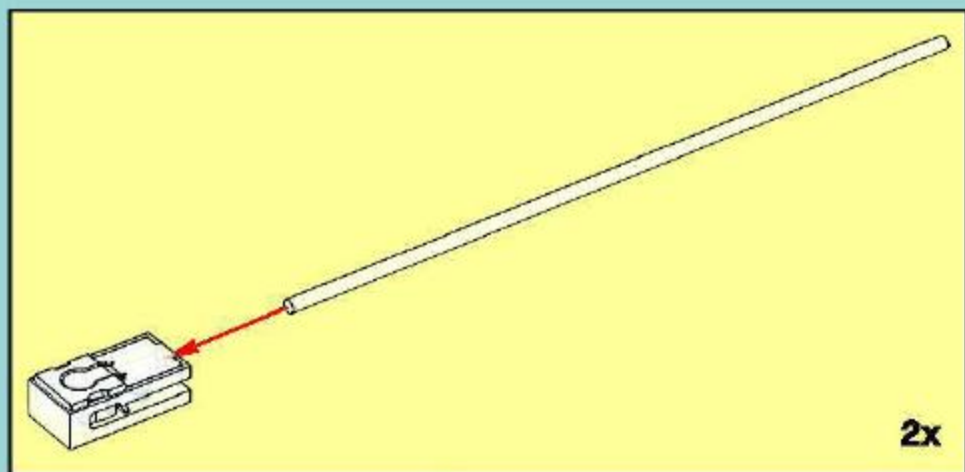

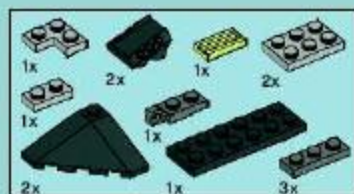

15

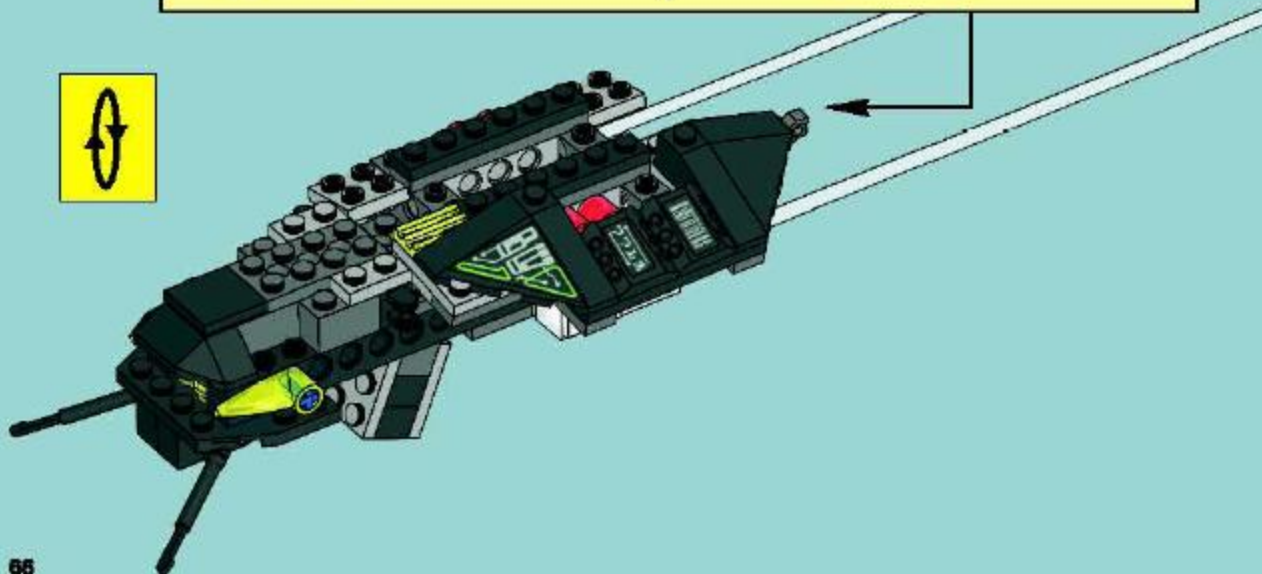
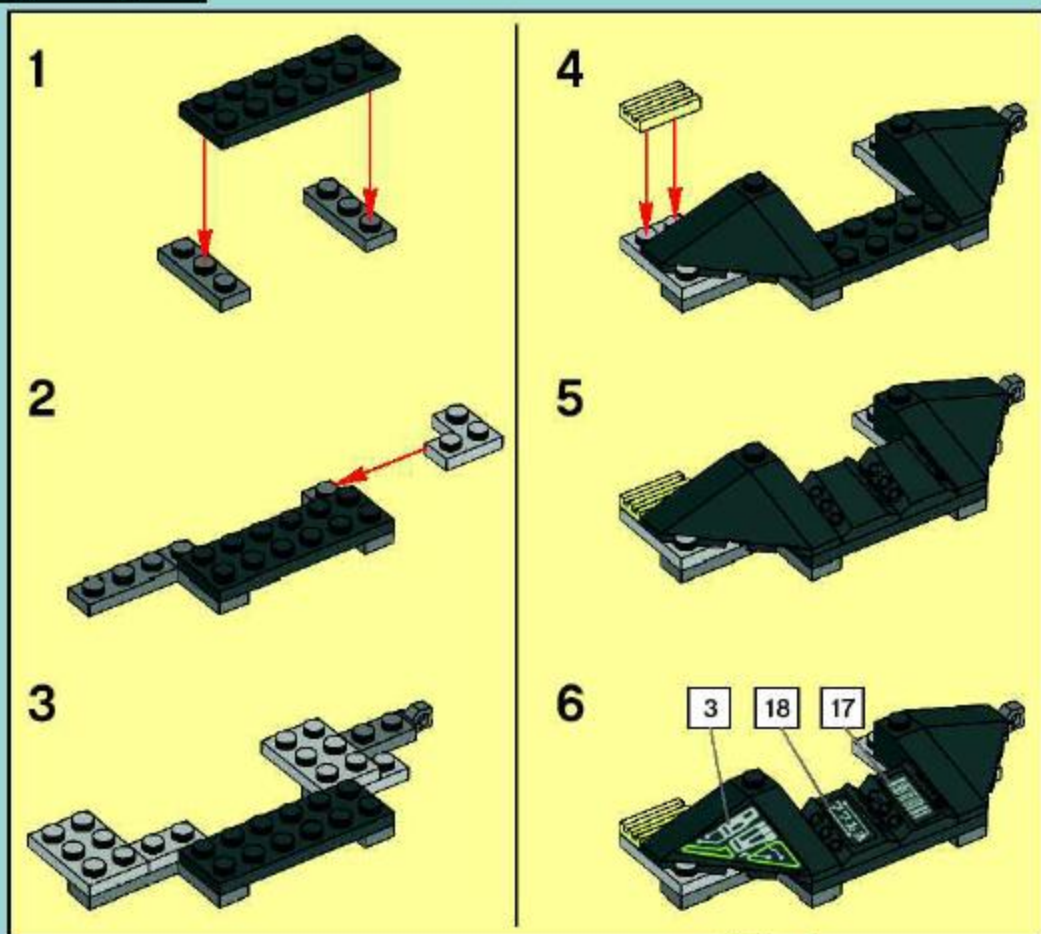

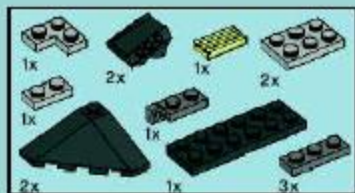

16

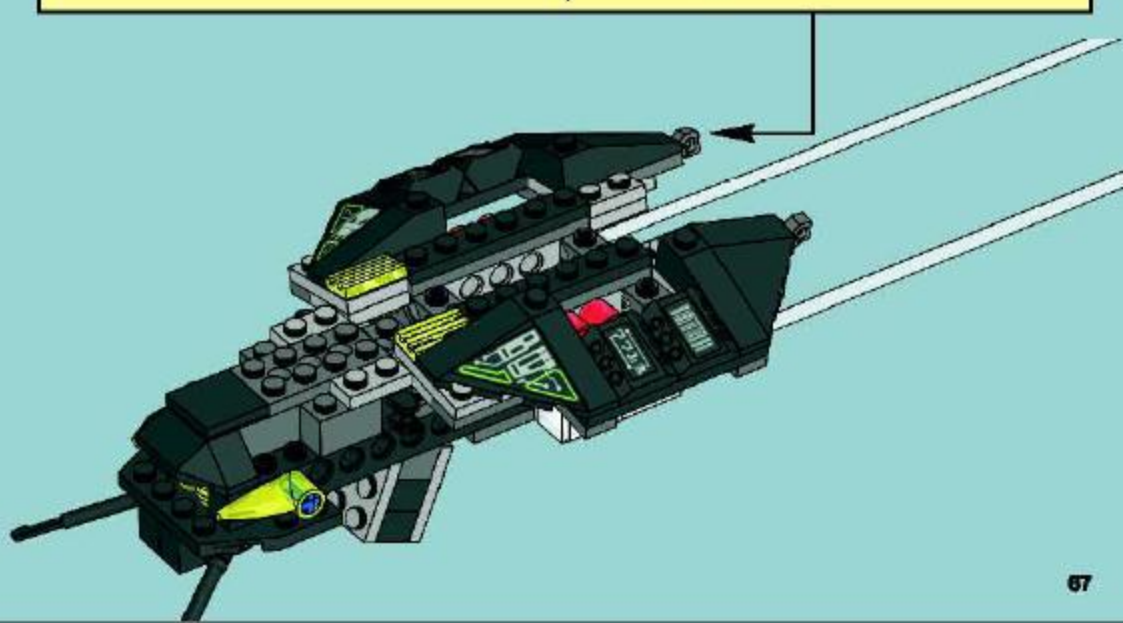
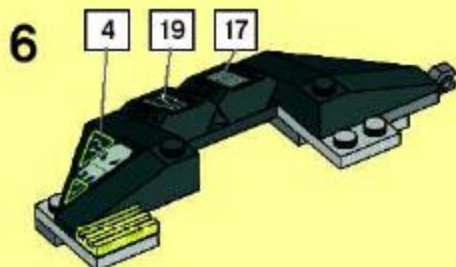
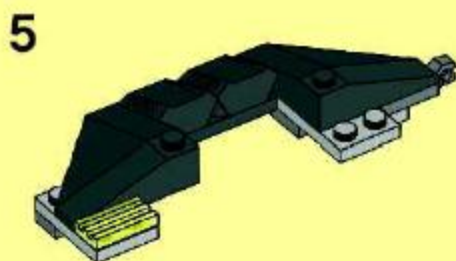
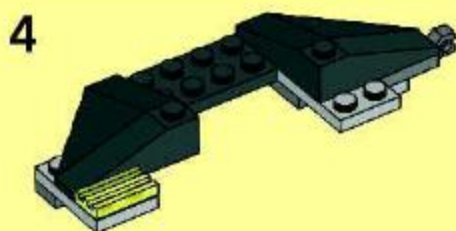
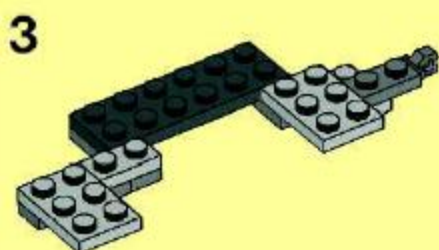
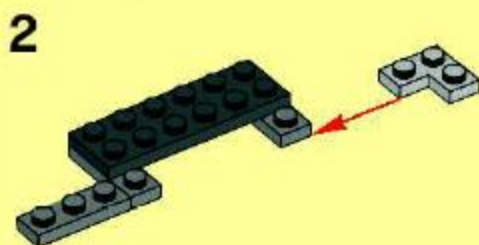
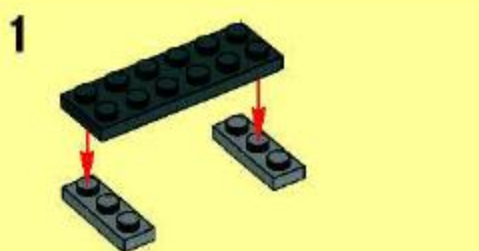

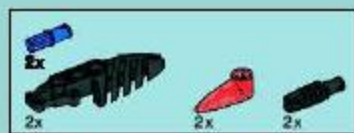

17

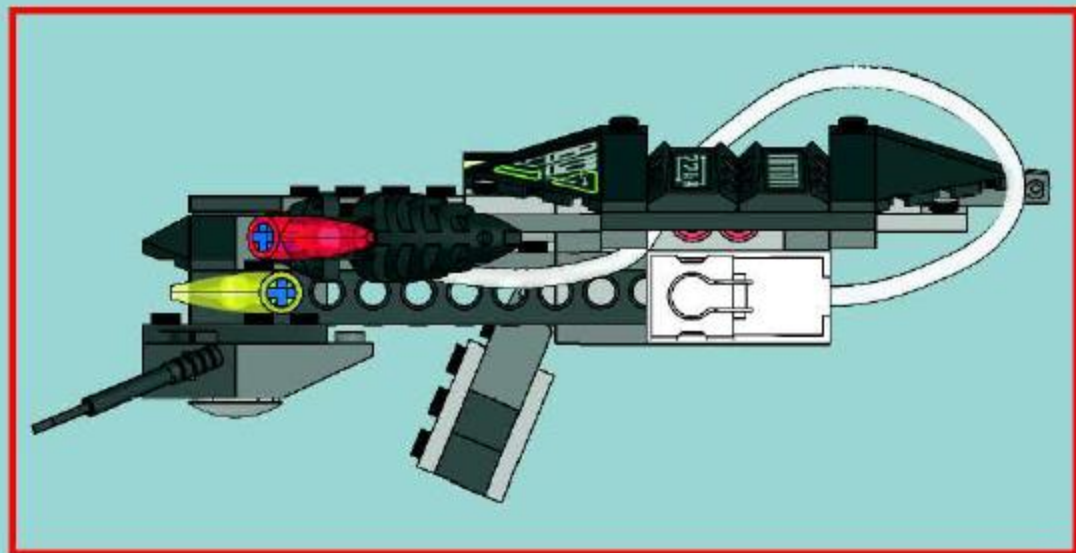
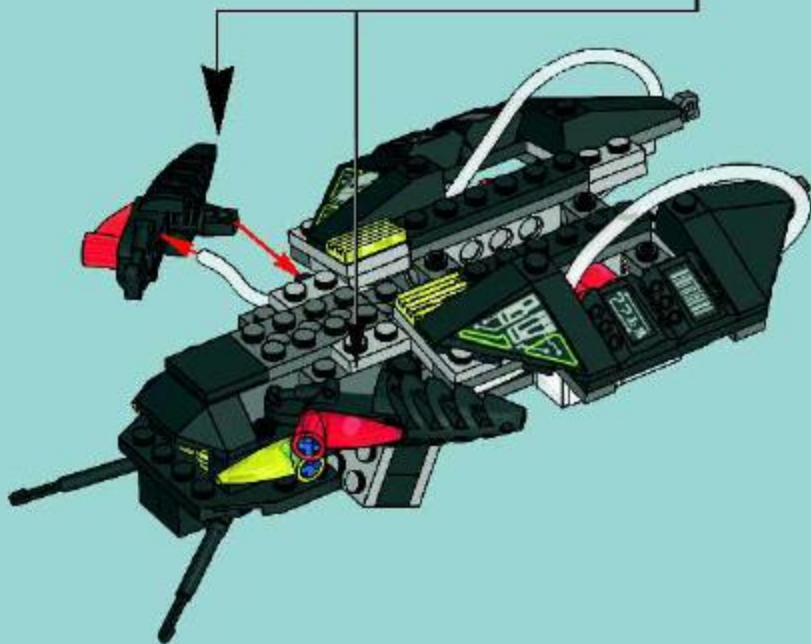
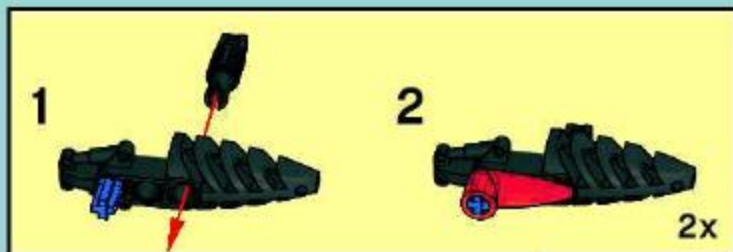



18

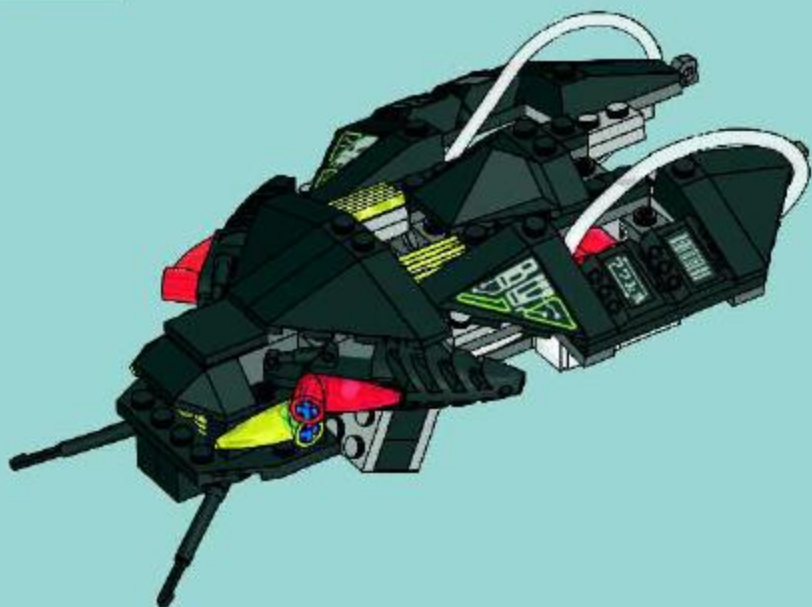

19

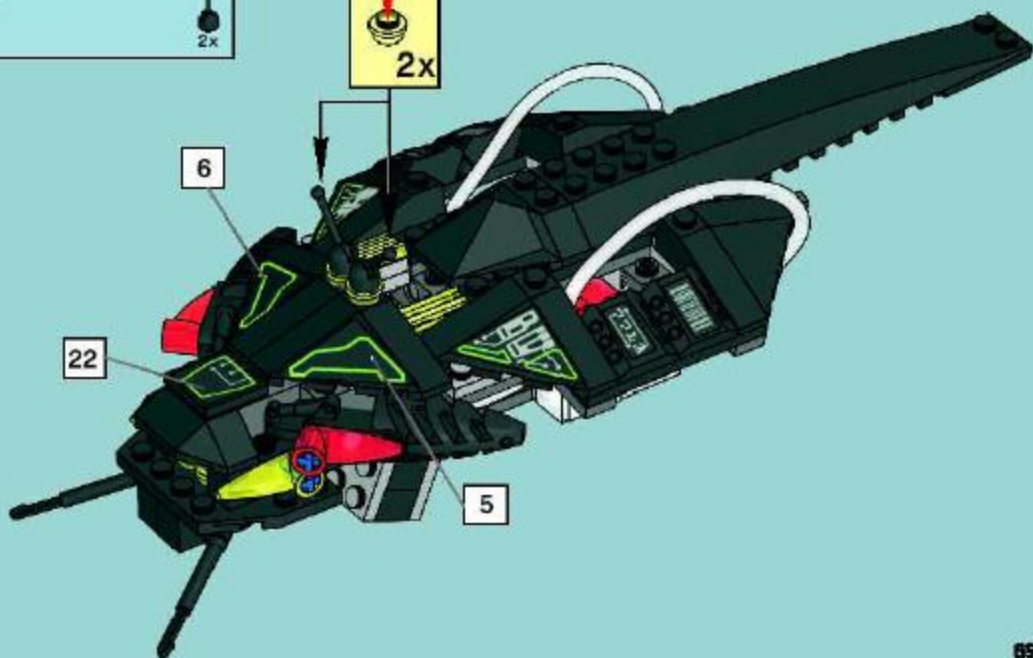
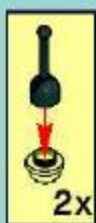

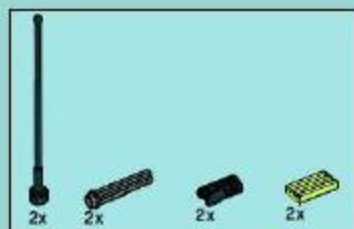

20

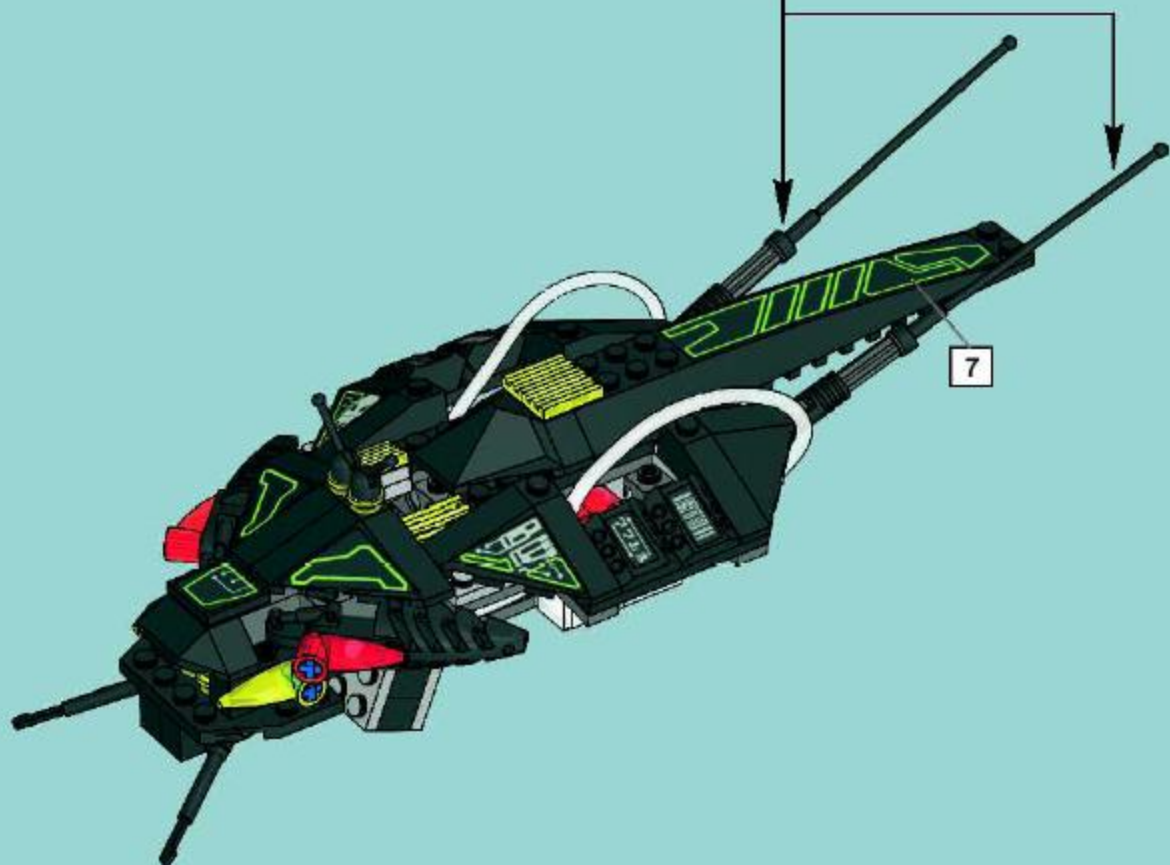
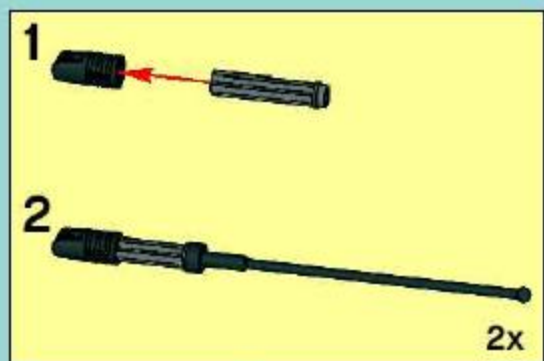

18

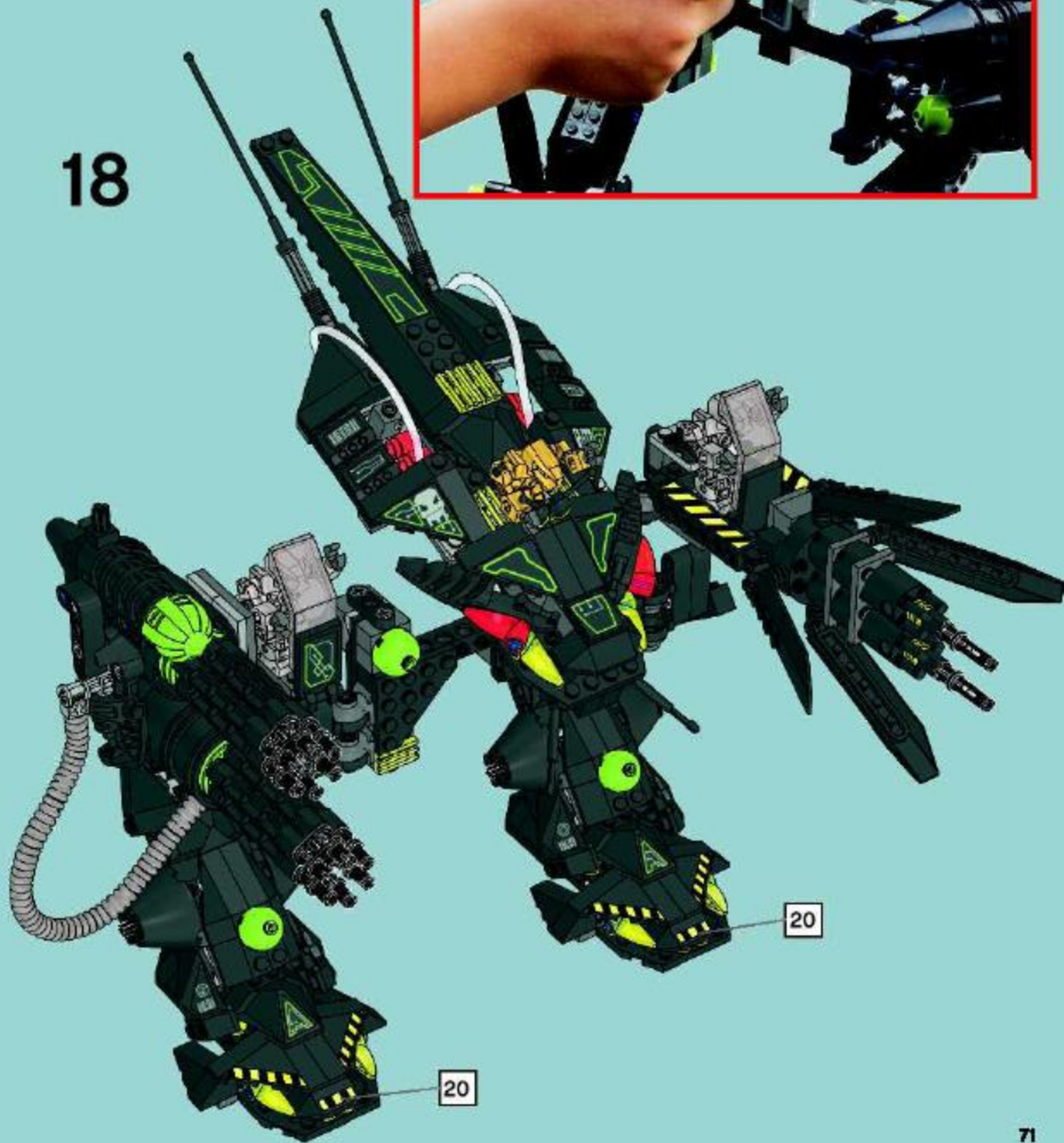







Win! Gagne! 当たります Gewinne!

Win LEGO products

We would like to know what you think about your new LEGO product. Log on to the web address below for further instructions.

Gagne des produits LEGO

Nous aimerions savoir ce que tu penses de ton nouveau produit LEGO. Tu obtiendras davantage d'informations en visitant le site Internet indiqué ci-dessous.

Gewinne LEGO produkte

Wir sind sehr an deiner Meinung über dein neues LEGO Produkt interessiert. Gehe einfach zu der unten angegebenen Webadresse – dort findest du weitere Informationen.

Estimado usuario LEGO

Al contestar algunas preguntas en inglés, francés, alemán o japonés, en el sitio www.acnielsen.aim.dk/lego, podrás participar en el sorteo de algunos valiosos premios LEGO.

Caro Consumidor da LEGO

Ao responder a algumas perguntas em Inglês, Francês, Alemão ou Japonês no endereço www.acnielsen.aim.dk/lego irá participar num concurso para ganhar valiosos prémios da LEGO.

Kedves ifjú LEGO Vásárló

Ha ellátogat a www.acnielsen.aim.dk/lego honlapra és ott angol, francia, német vagy japán nyelven megválaszolsz néhány kérdést, akkor részt veszel egy versenyben, amelyben értékes LEGO díjakat nyerhetsz.

日本でレゴ®製品が当たります

私たちは、皆さんが買い求めたレゴ®製品についてどんな感想をお持ちか、知りたいと思っています。質問に答えて、美しいレゴ®製品の抽選に当選しませんか。アンケートの回答には、ほんの少しだけしかありません！詳しくは、以下のウェブアドレスまでアクセスしてください。



www.acnielsen.aim.dk/LEGO



Any questions regarding your new LEGO product, please contact:

**Customer Service | Kundenservice
Service Consommateurs
Servicio Al Consumidor at
www.lego.com/service or dial**



00800 5346 5555

 :

1-800-422-5346

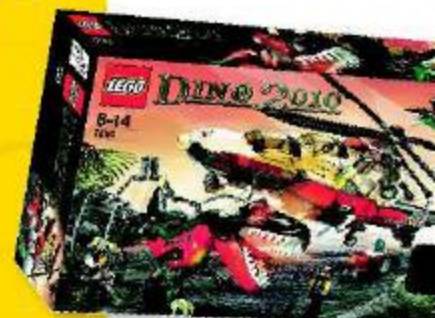



©2010 The LEGO Group 4832387

Discover the **LEGO® UNIVERSE!**
 Entdecke das **LEGO® UNIVERSUM!**
 Ontdek het **LEGO® UNIVERSUM!**
 Découvrez **L'UNIVERS LEGO® !**

LEGO club

FREE LEGO Magazines
 Des Magazines LEGO GRATUITS !
 GRATIS LEGO Magazine
 KOSTENLOSE LEGO Magazine



BIC25 BIC26 B106U B106V B106F B106C B106G B106E B106N
 Sign up now! Jetzt anmelden!
 Abonne toi maintenant! Meld je nu aan!
<http://club.LEGO.com/signup>

LEGO SHOP at HOME



www.LEGOshop.com/catalog