

LEGO

6981





1



2



3



4



5



6



7



2X

1



2



3

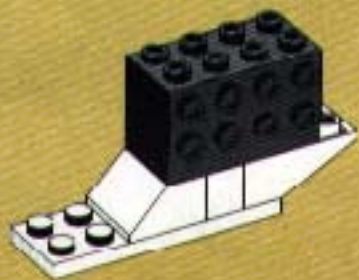

4



2X

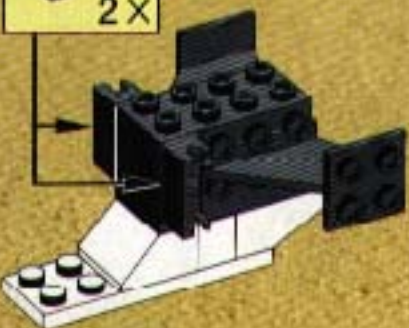

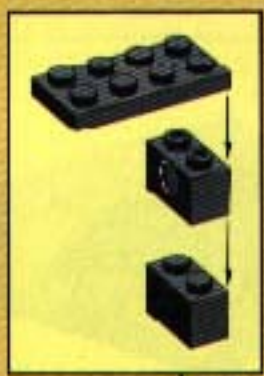

5

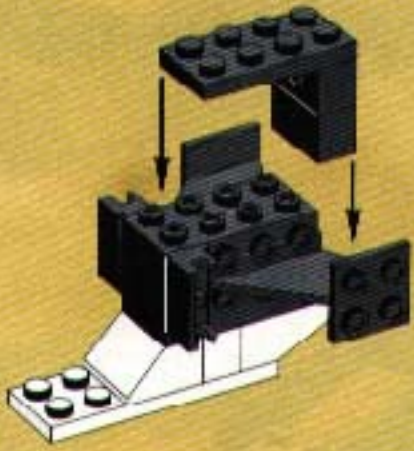

2x

6



7

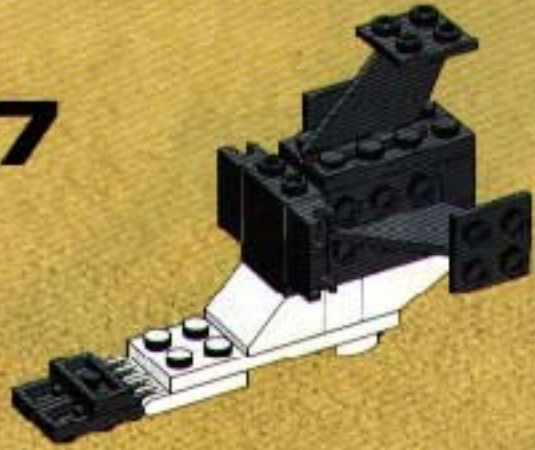

8

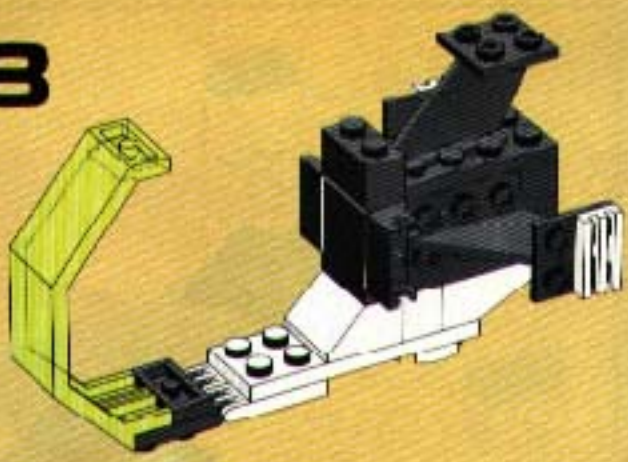

9

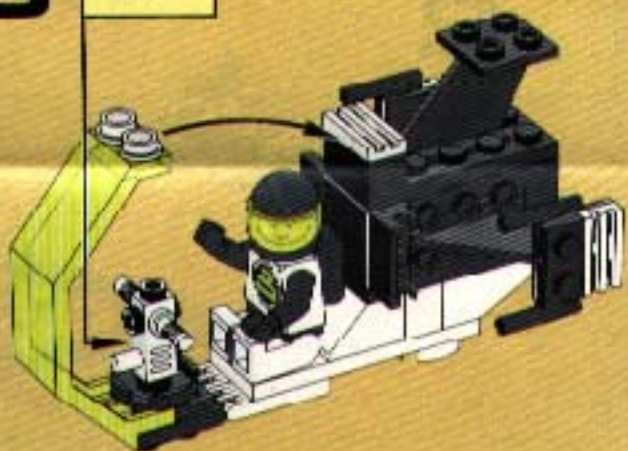

10

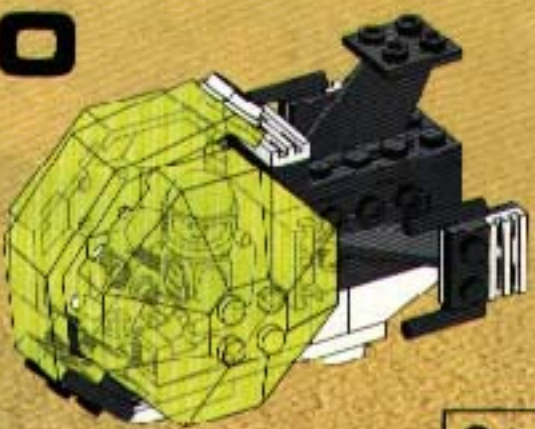

2x

1

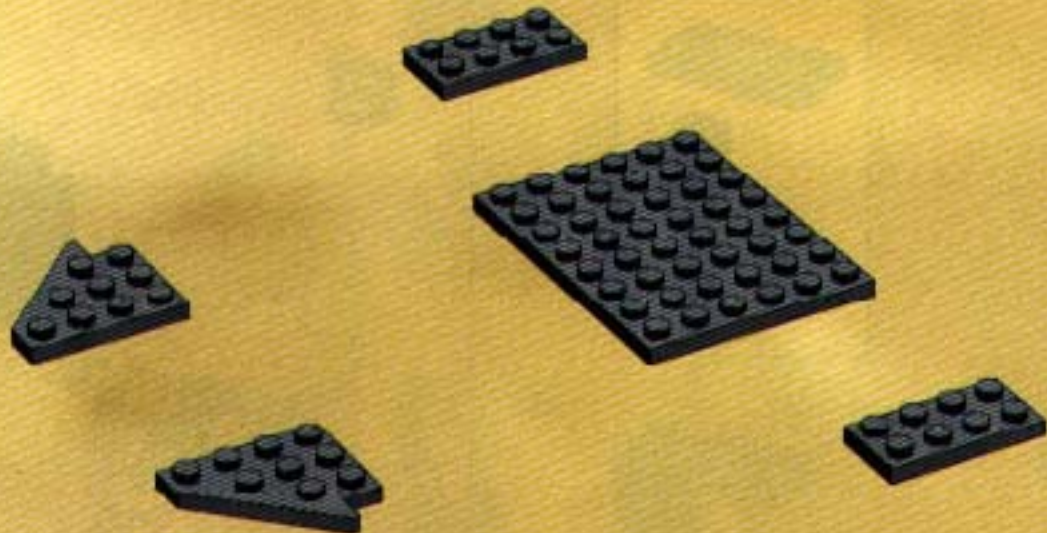

2

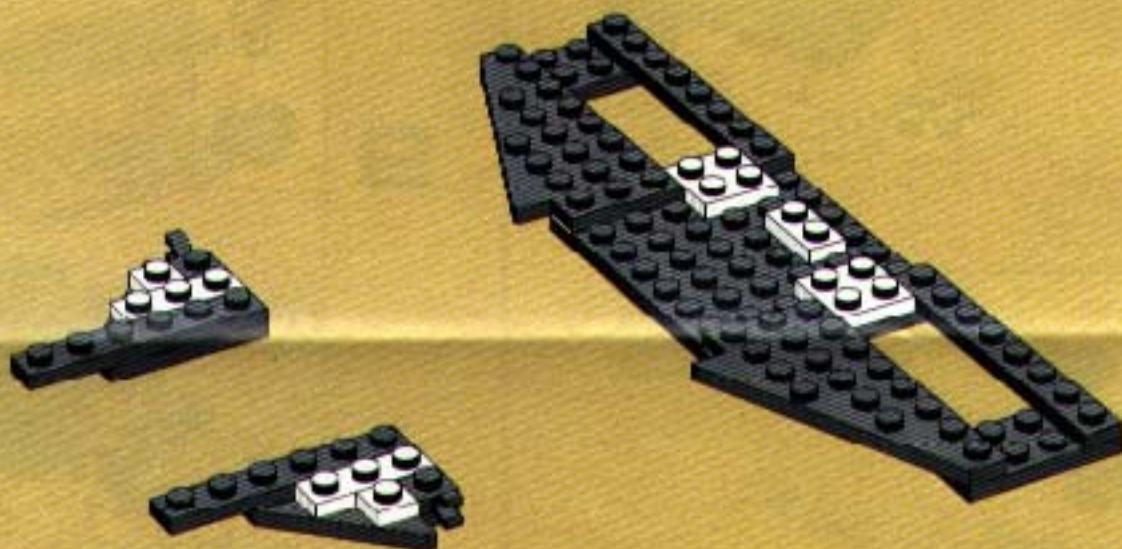

3

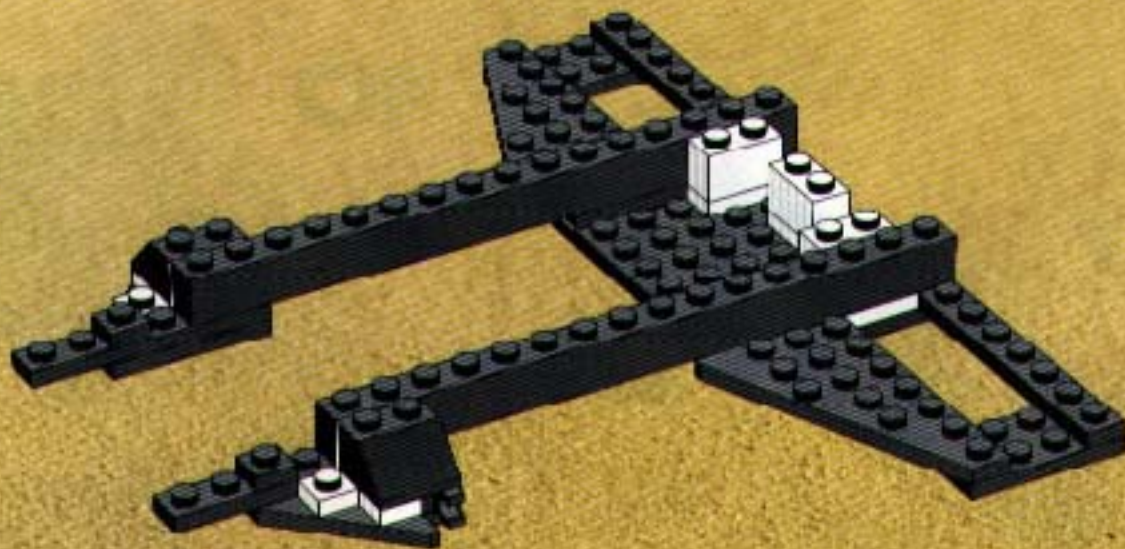

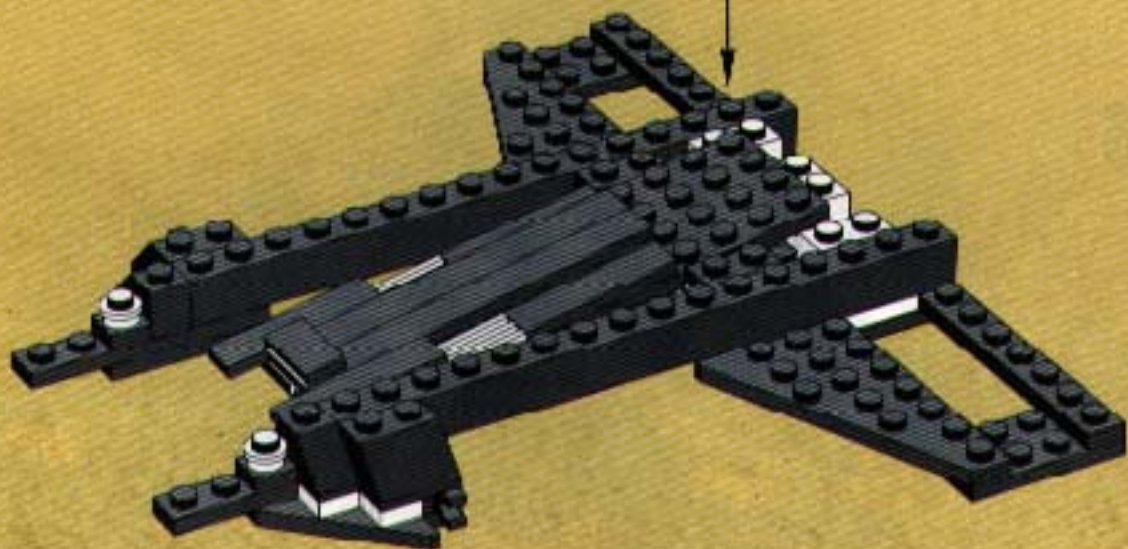
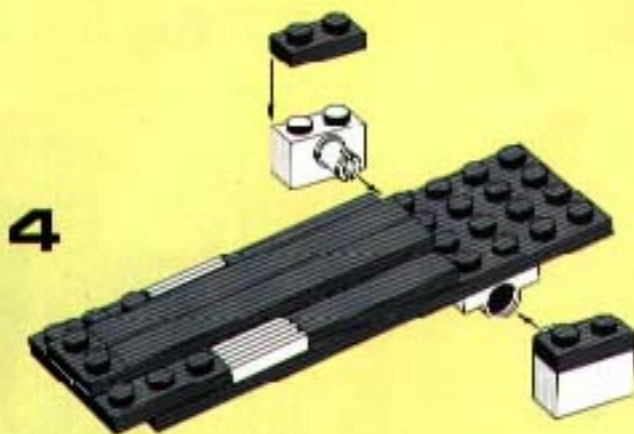

5

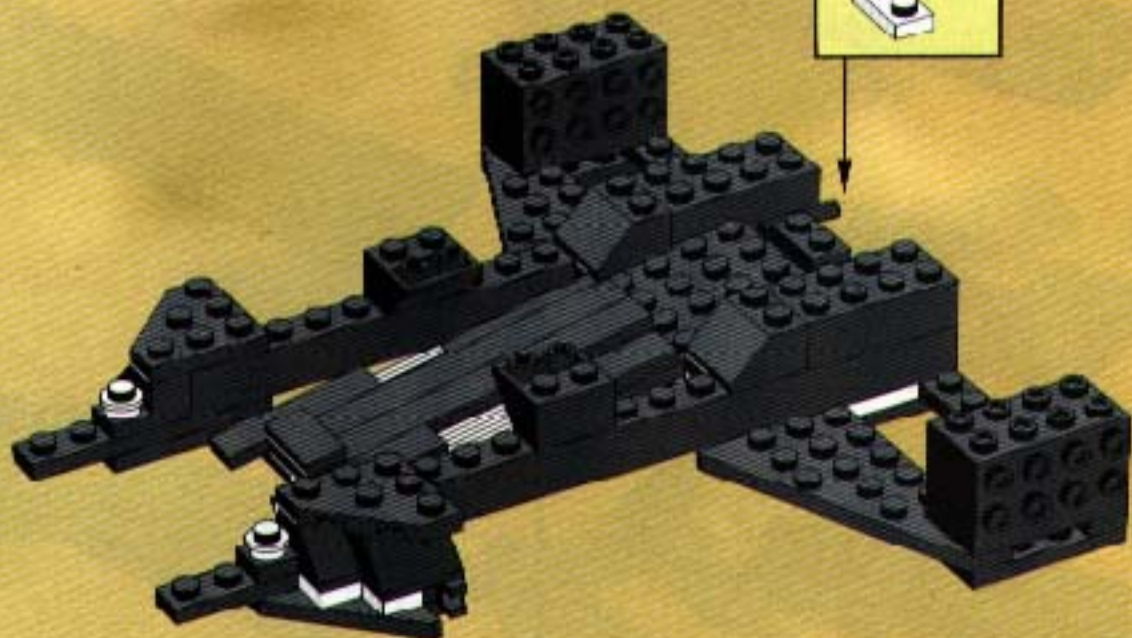

6

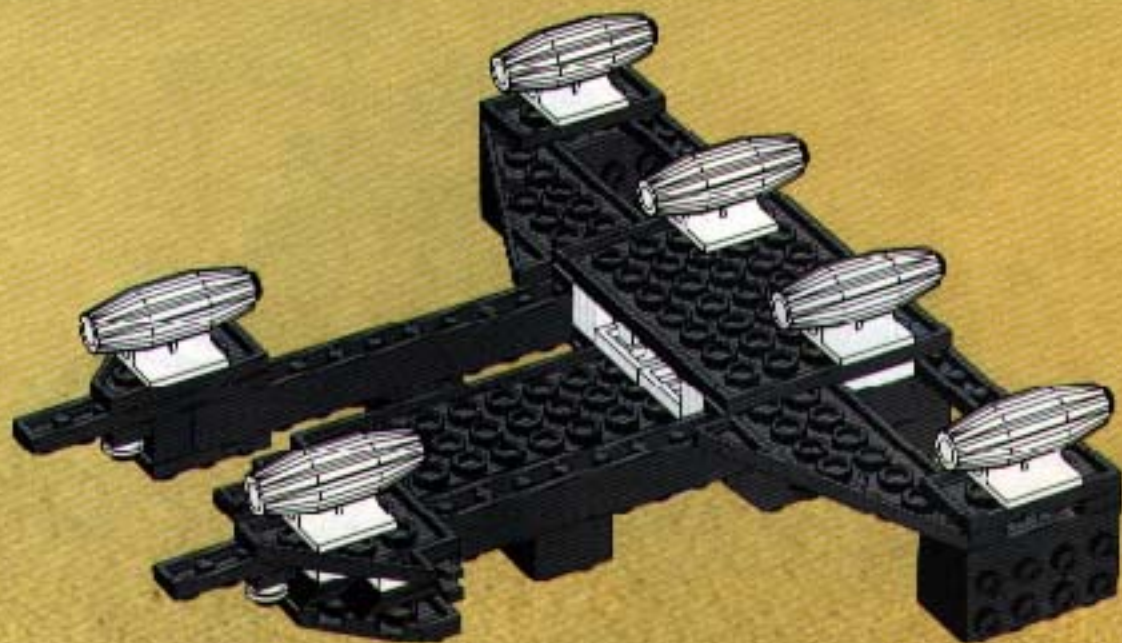

7

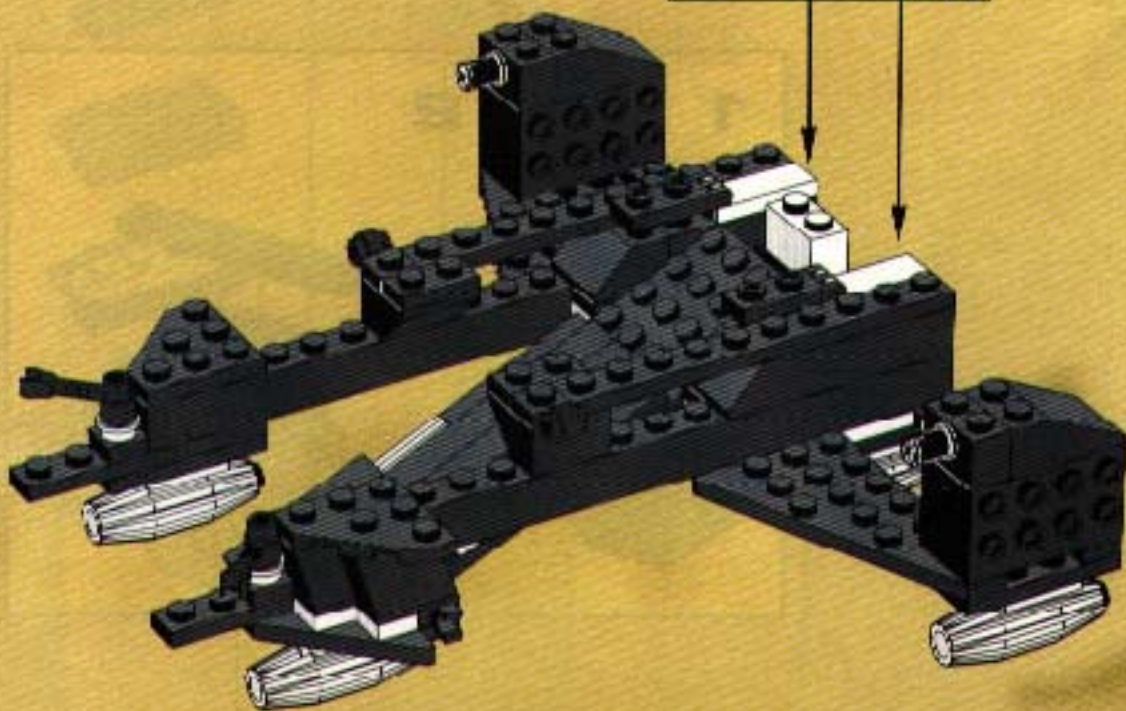

8

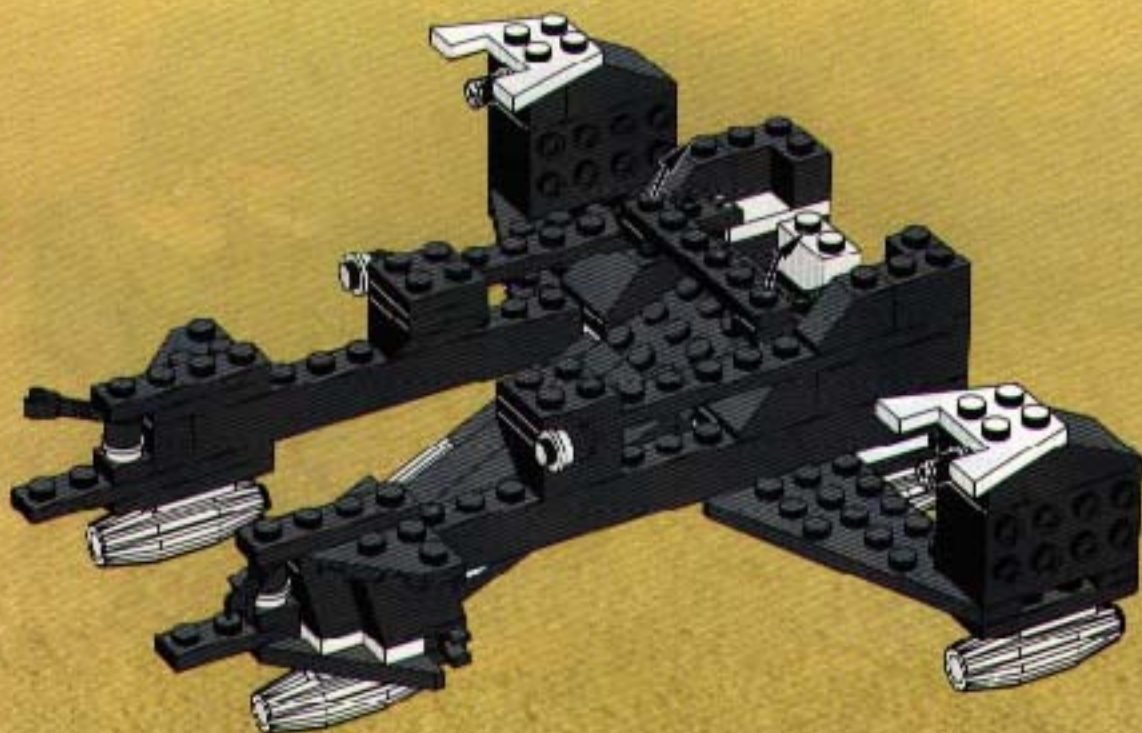

1



2

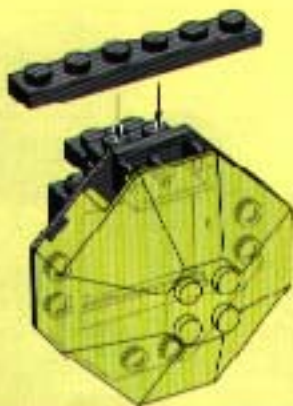

9

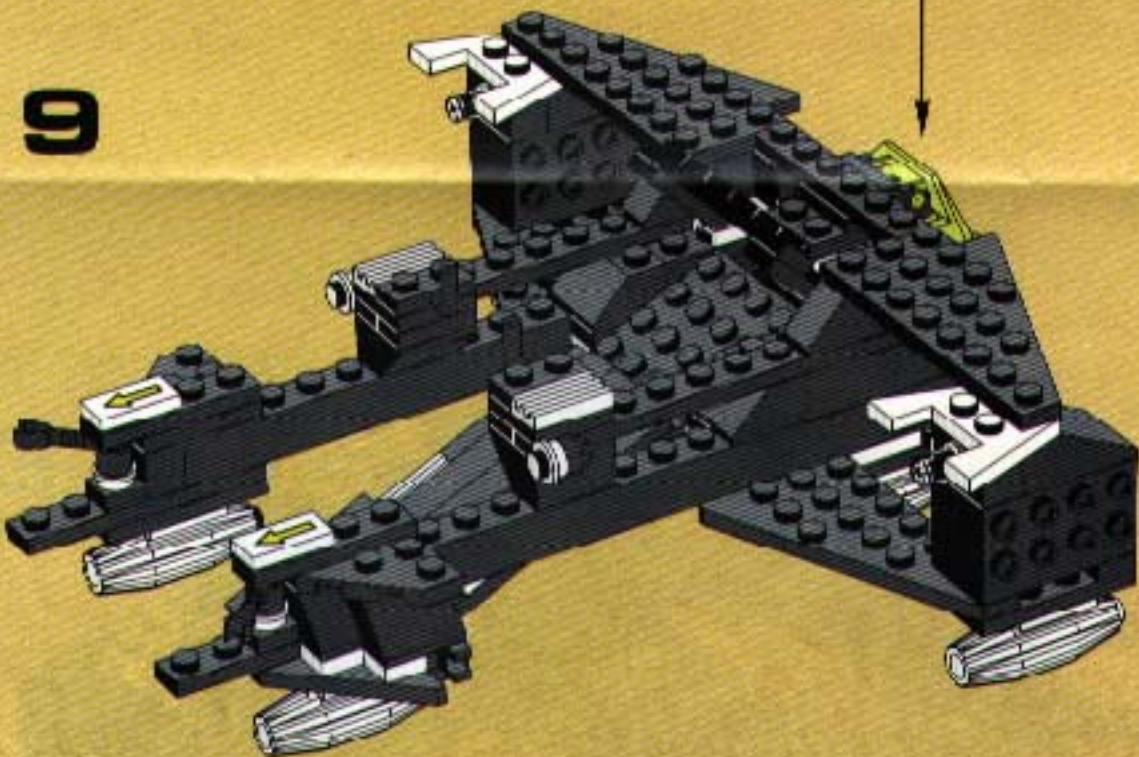

1



2



3



4



5

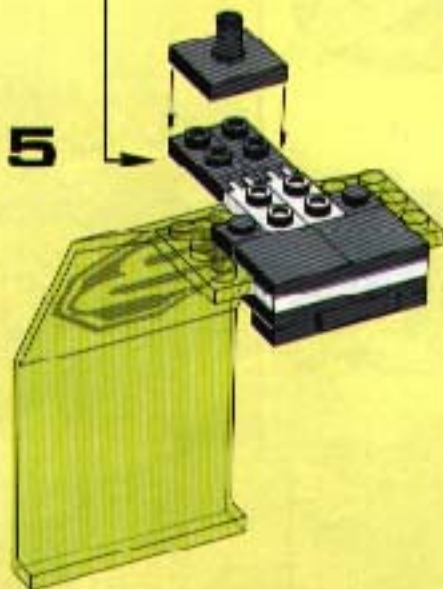

10

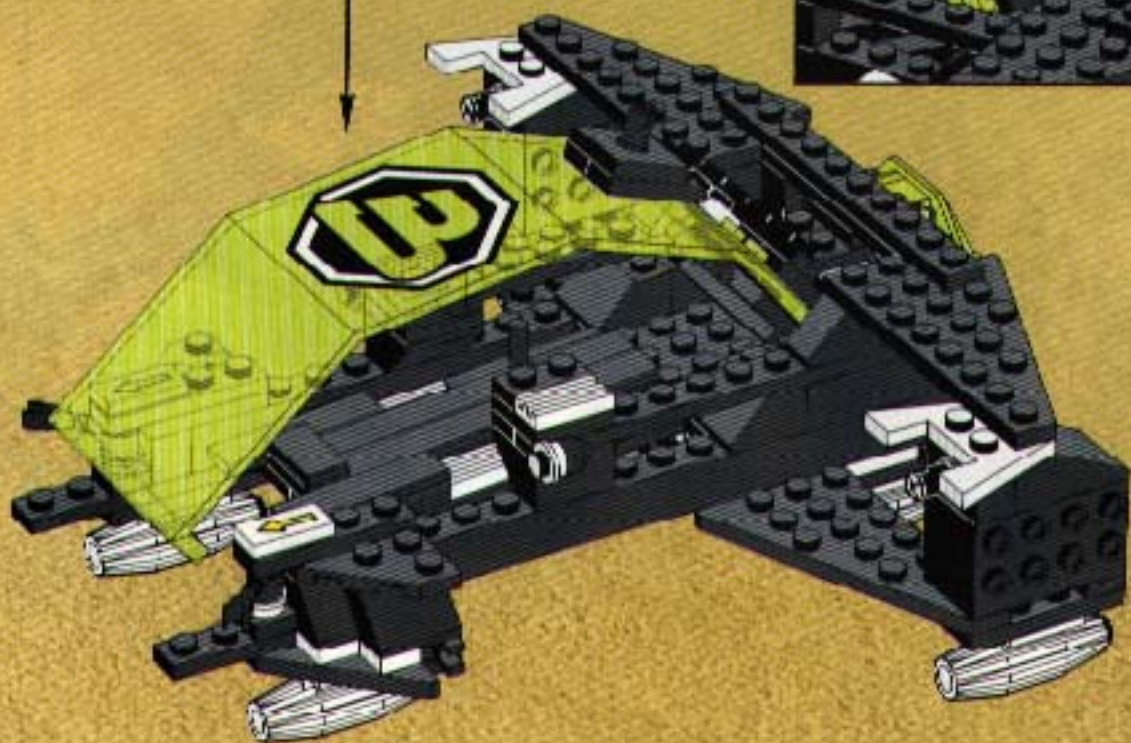

1



2



3



4



5

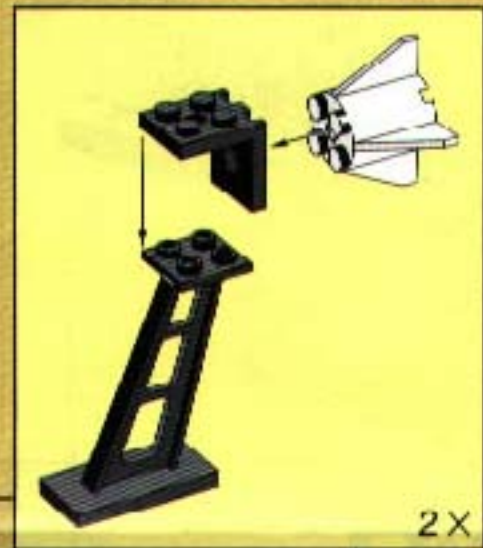

11

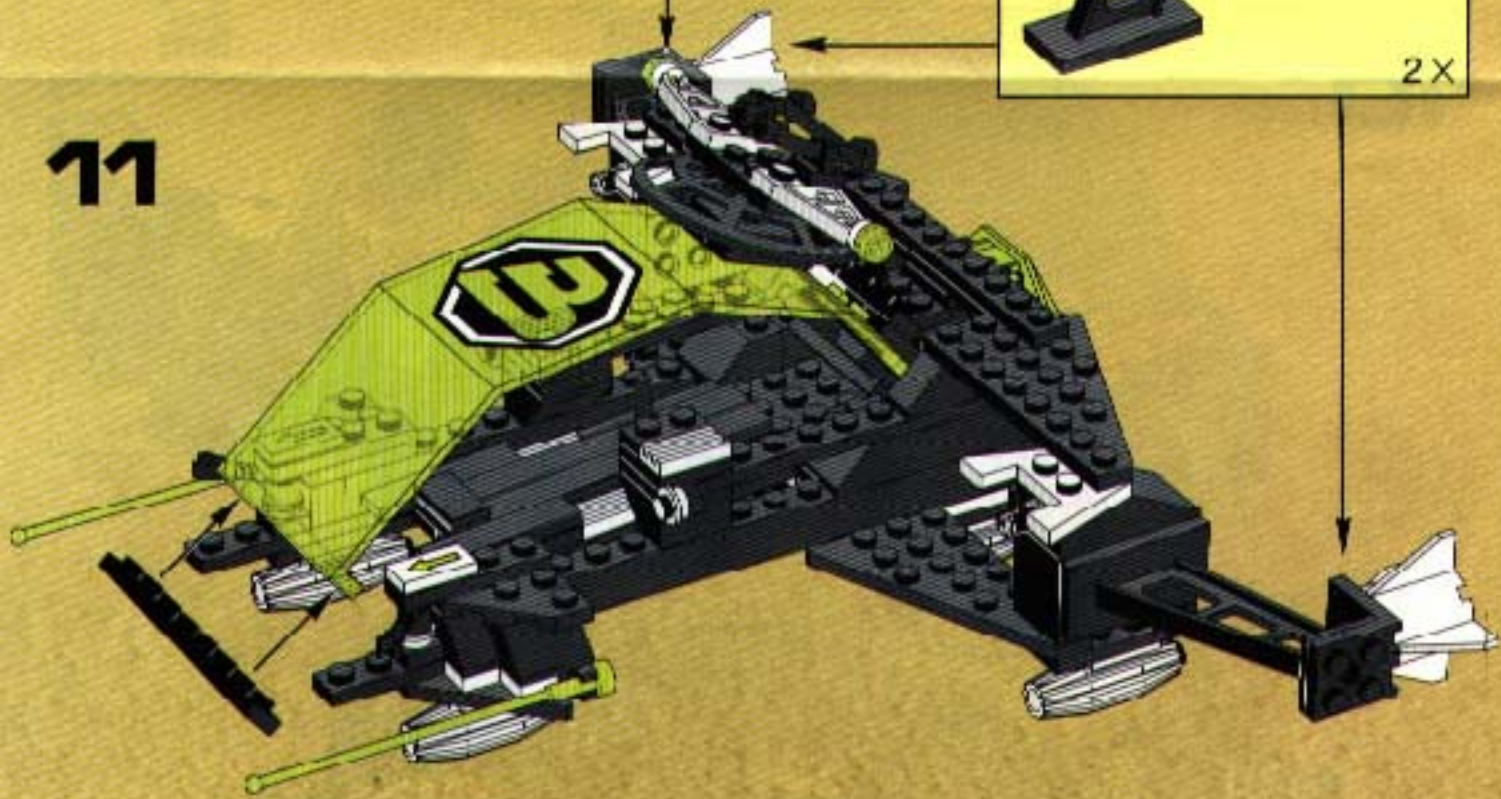

12



