

The LEGO logo is displayed in its characteristic white, bold, sans-serif font with a black outline, set against a red square background.

CREATOR

6-12

4892 - 1



Ideas



Instructions

4296271





Quick Build
 Schnellbaumodelle
 Construction rapide
 Costruzione rapida
 Snel bouwen
 Construcción rápida
 Byg hurtigt
 Nopeaan rakentämiseen
 Bygg snabbt
 Construção Rápida
Γρήγορες Κατασκευές
 Kísérletezőknek



Experienced Build
 Könnemodelle
 Construction normale
 Costruzione esperta
 Bouwen voor gevorderden
 Construcción experta
 Byg videre
 Kokeneille rakentajalle
 Bygg mer
 Construção para Experimentados
Εμπειρικές Κατασκευές
 Haladóknak





1

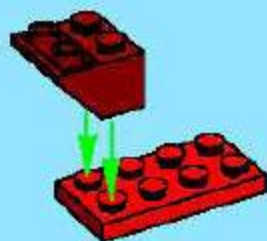

2



3



1



2



3



4



5



6



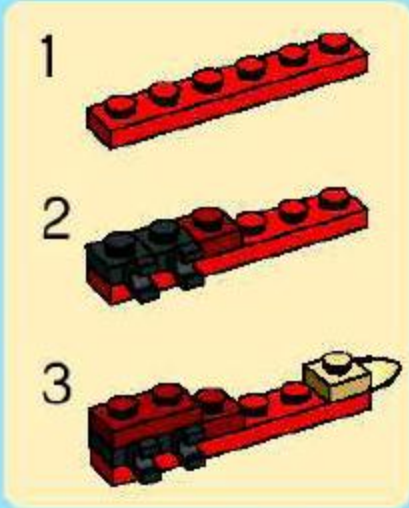

7

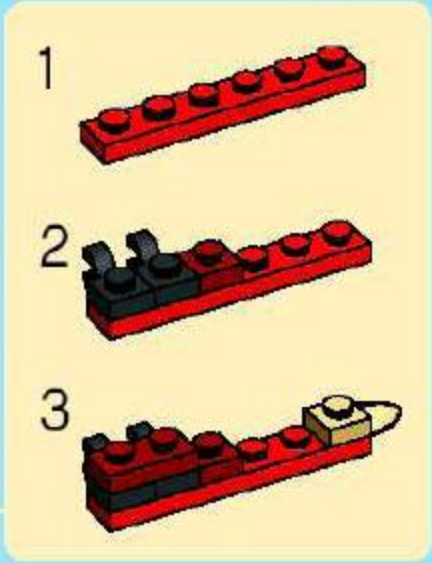

8

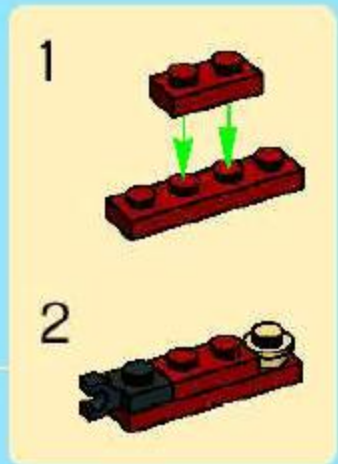

1

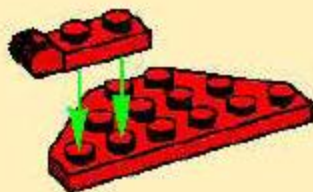

2



3

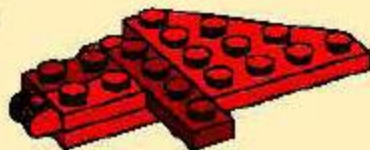

4



5



6

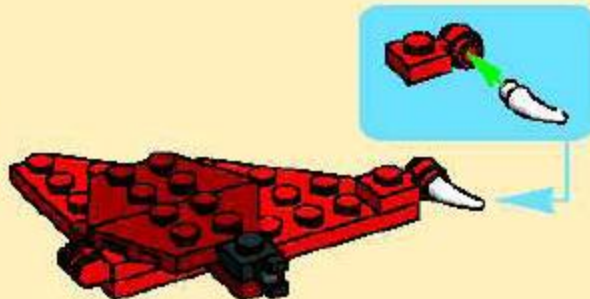

9



1



2



3



4



5



6



10



1



2



3



4

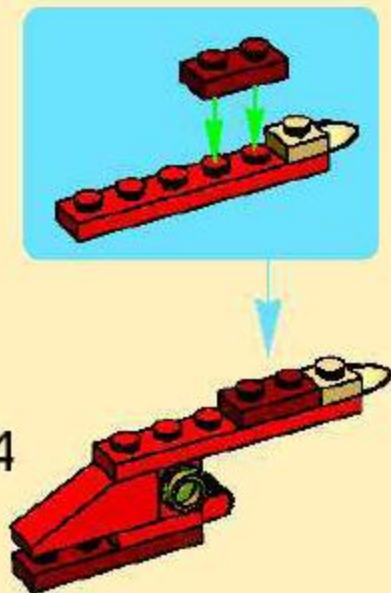

11



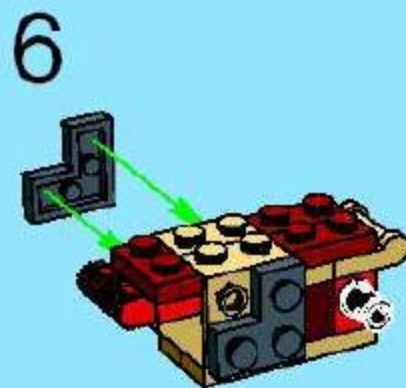
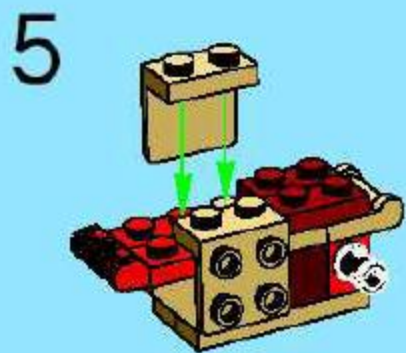
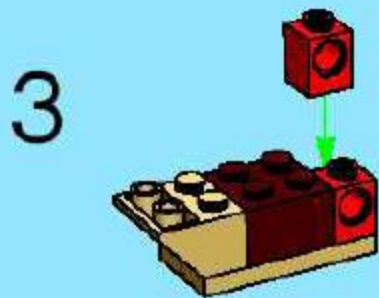
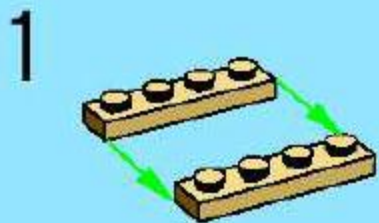

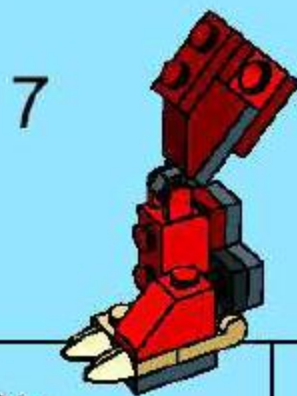
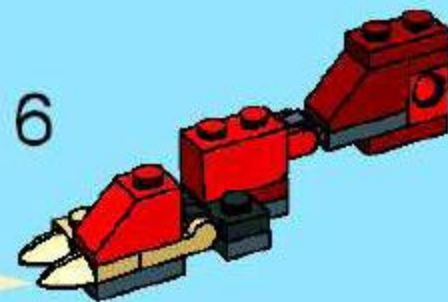
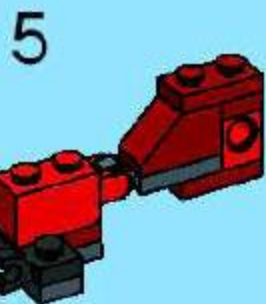
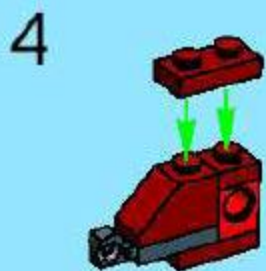
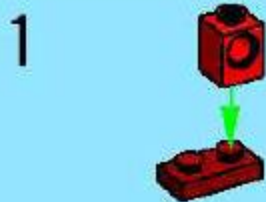

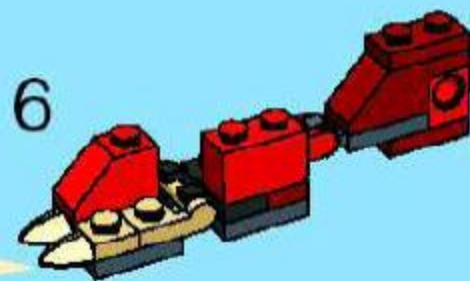
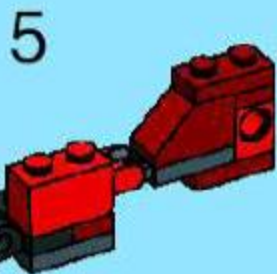
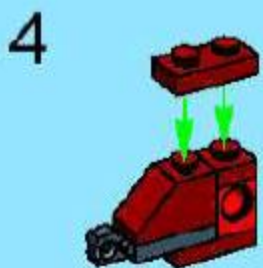
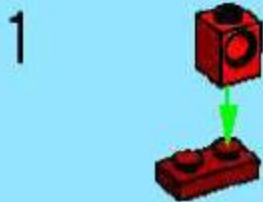

10

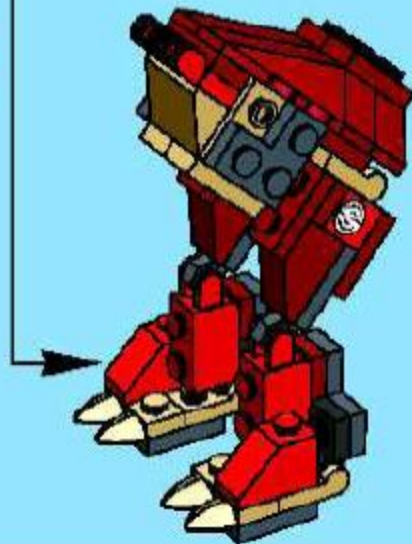

11

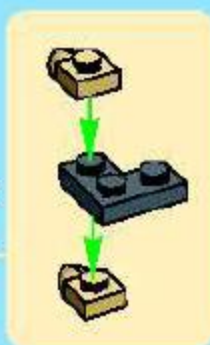
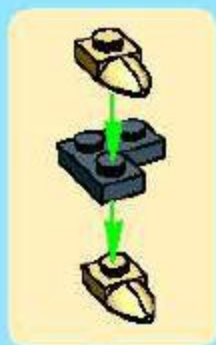

12

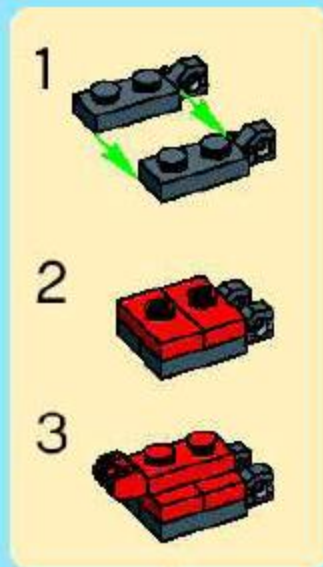

1



2



3



4



5



6



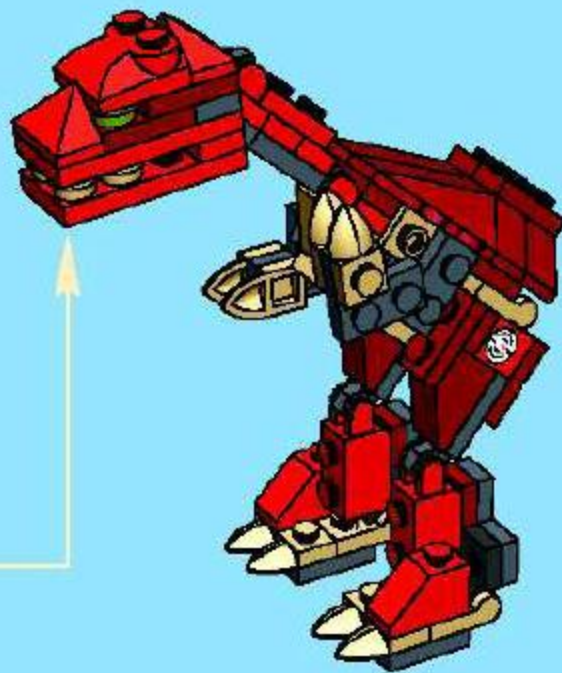

13

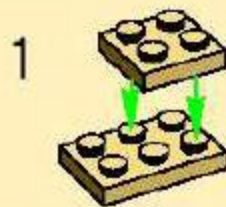
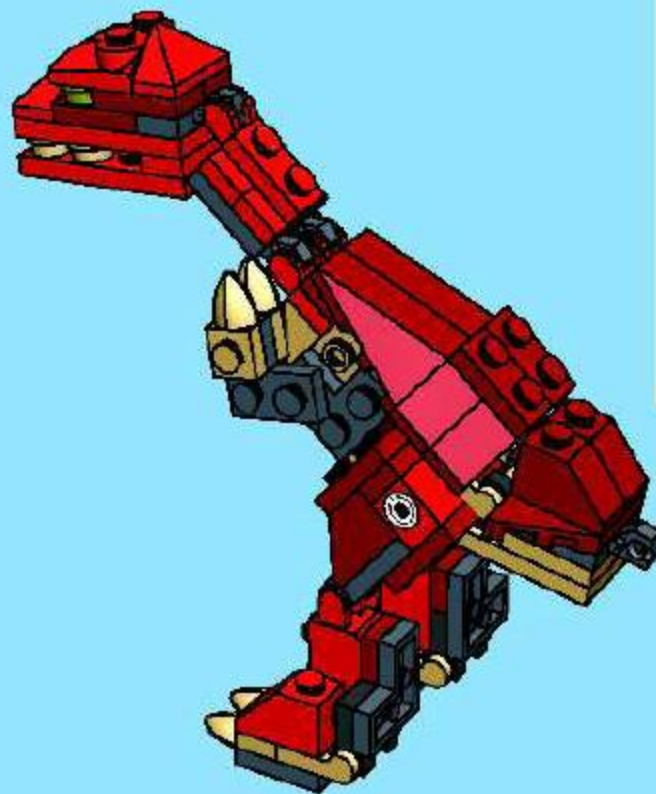

14

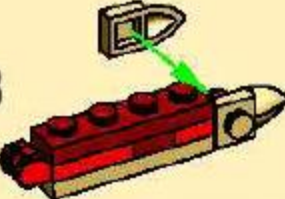

15

- 1 
- 2 
- 3 

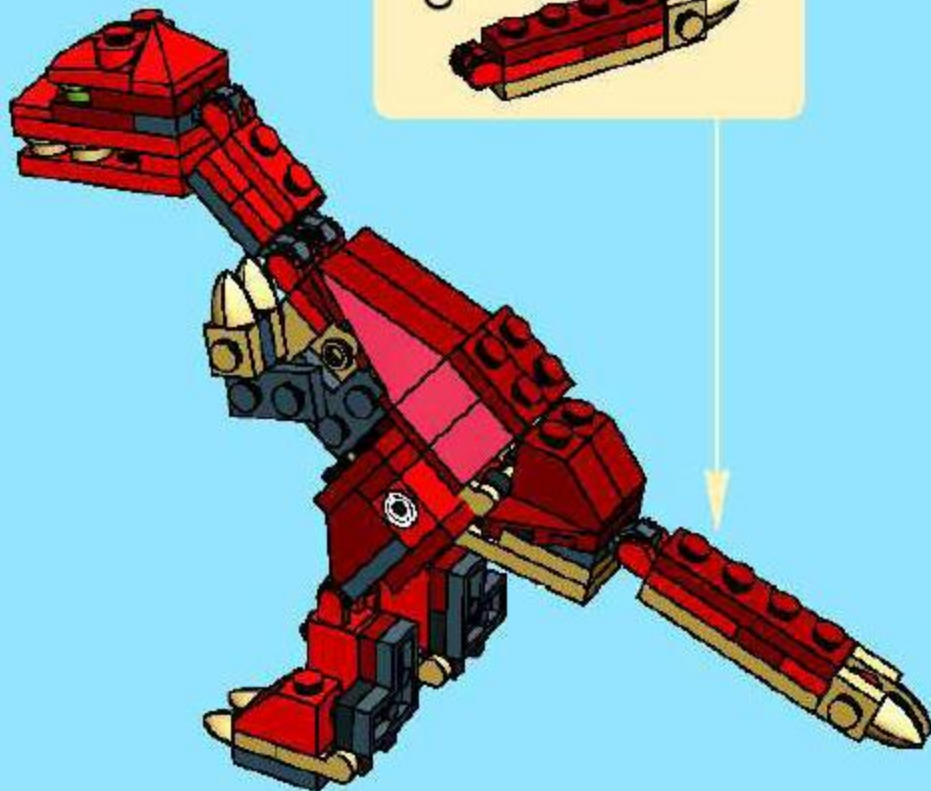

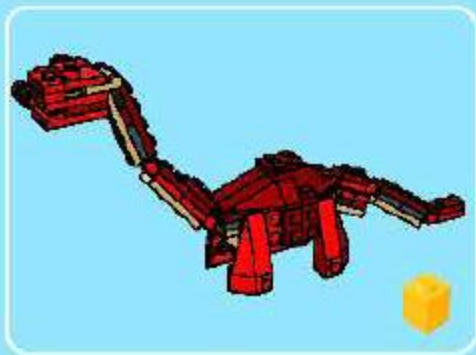

1

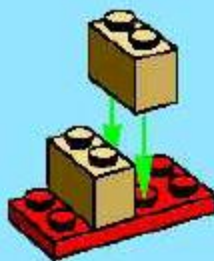

2

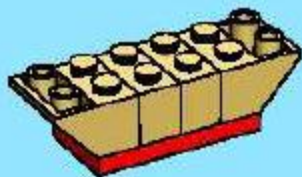

3



4



5

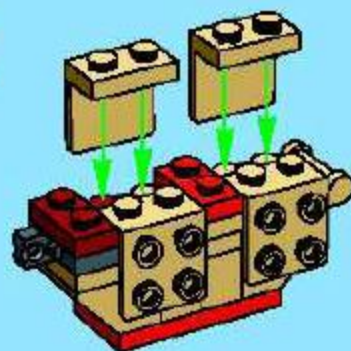

6

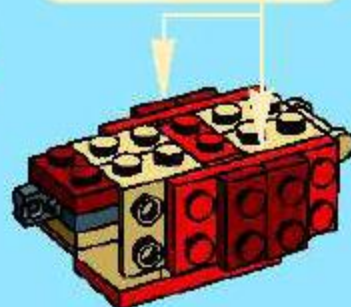

7



8

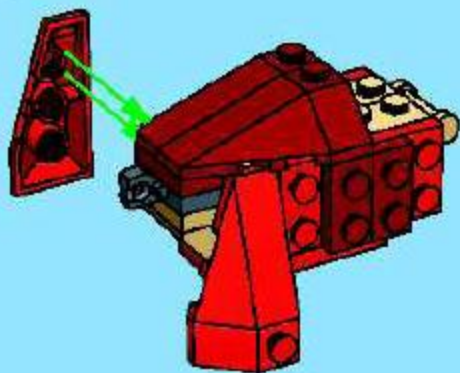

9



10



11



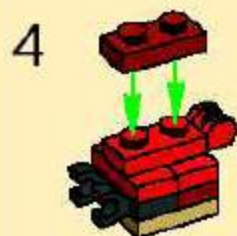
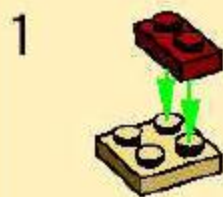

12

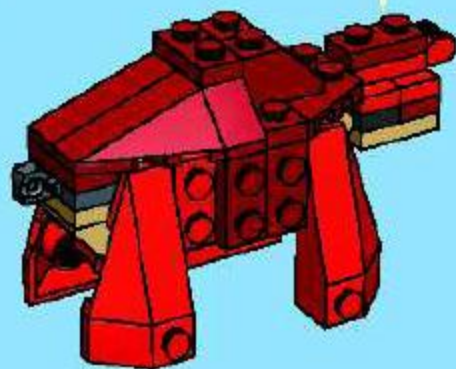

13



1



2



3

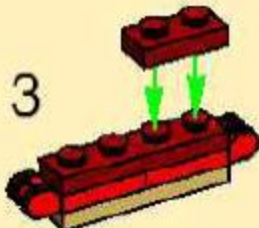

14



1



2



3



15

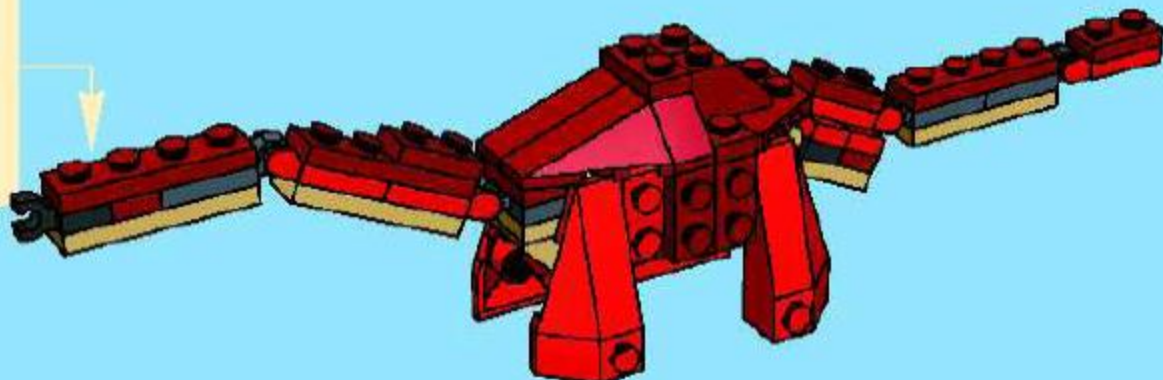

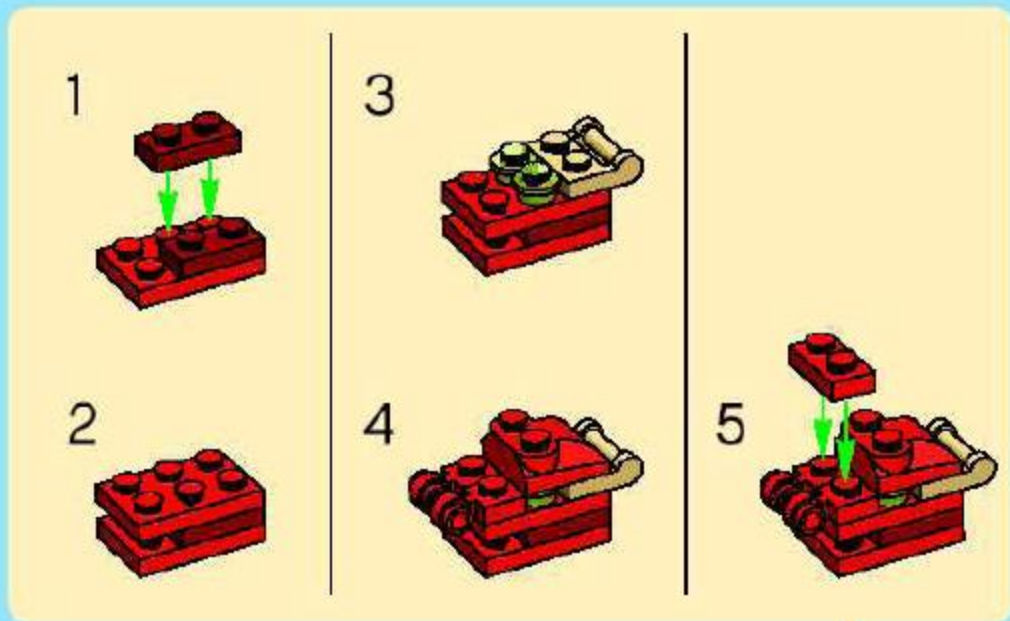

16

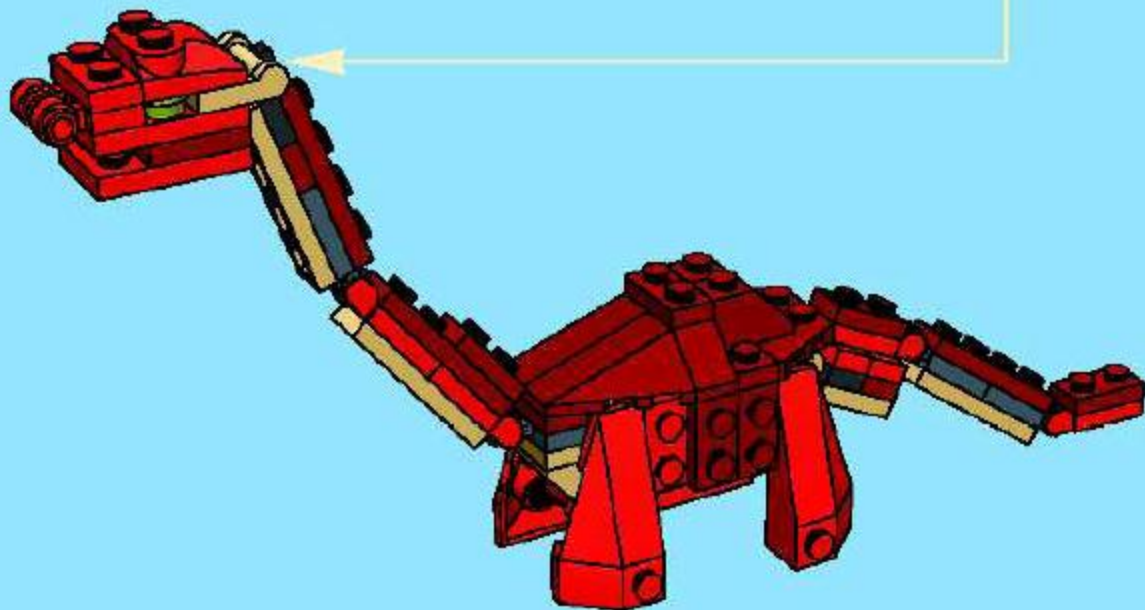





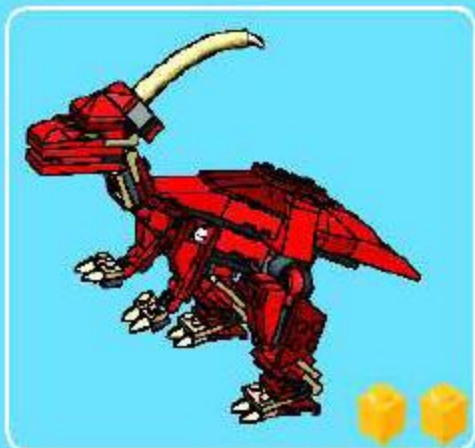

1

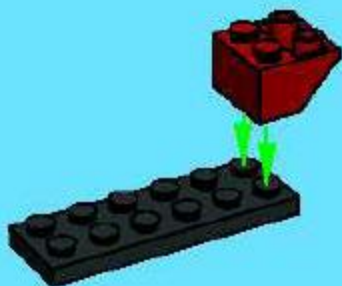

2

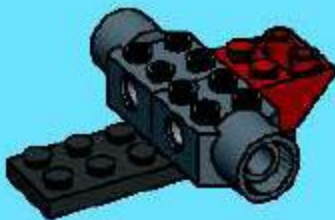

3



4

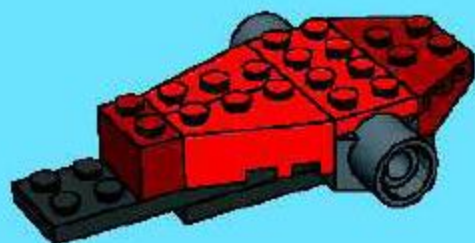

5

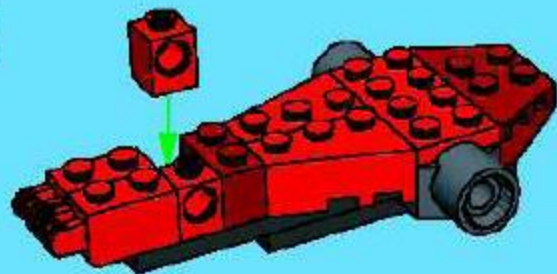

6



1



2

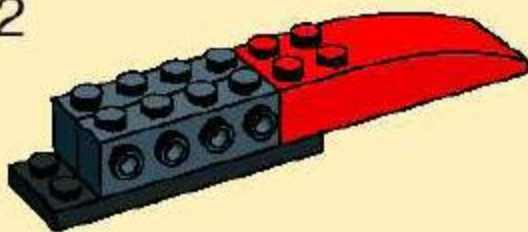

3

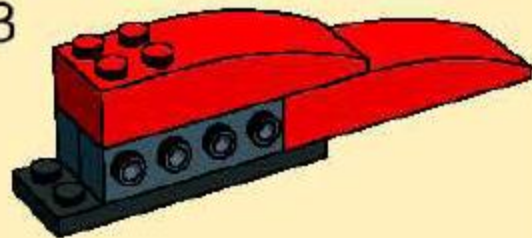

7

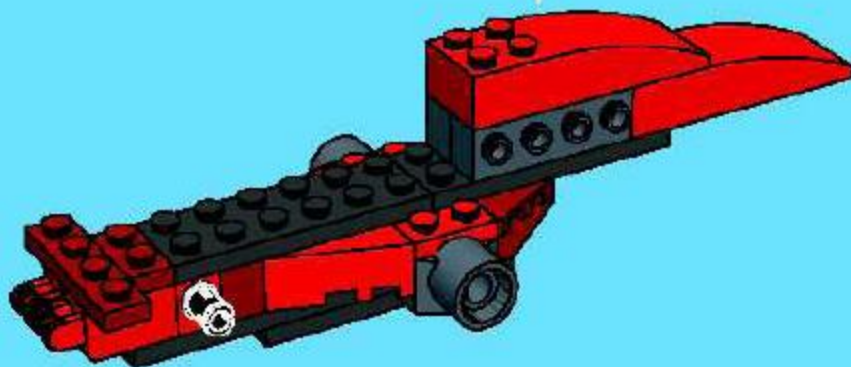

8

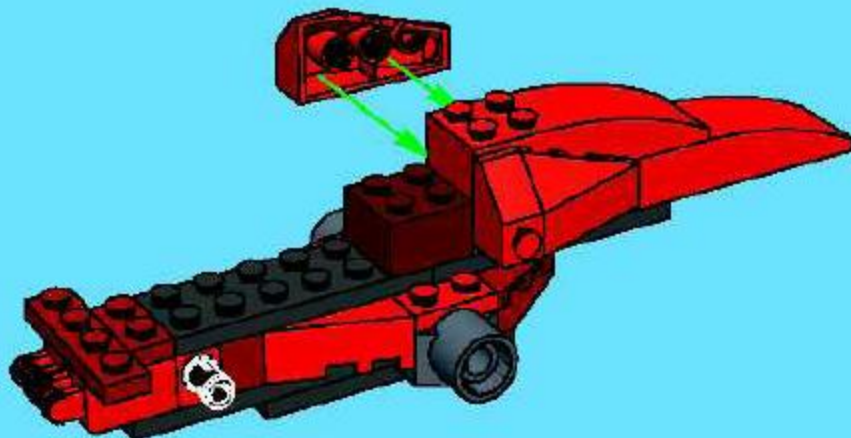

9

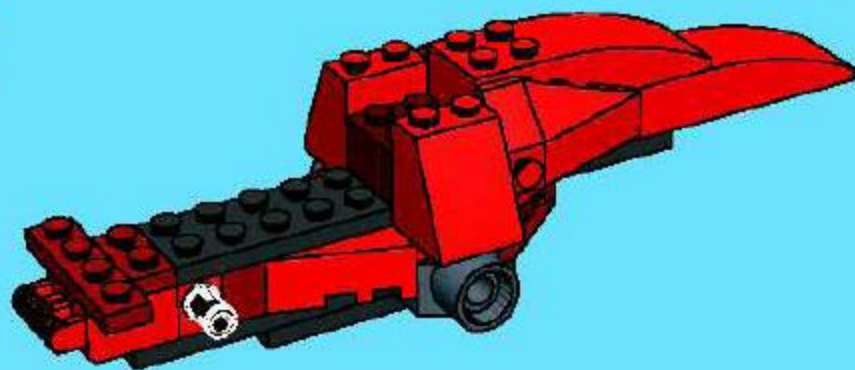

10

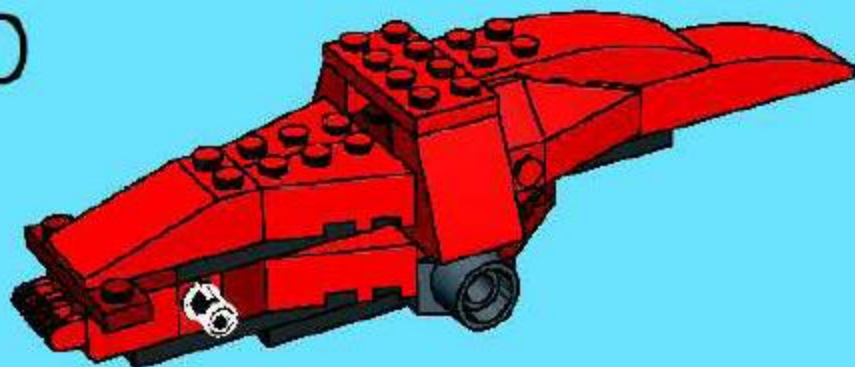

11

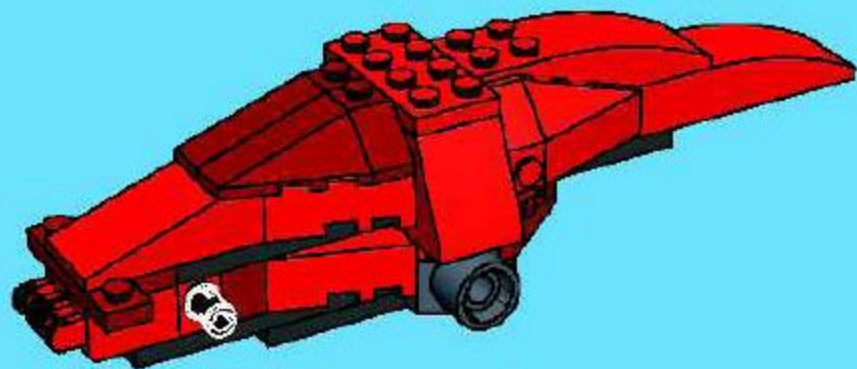

12

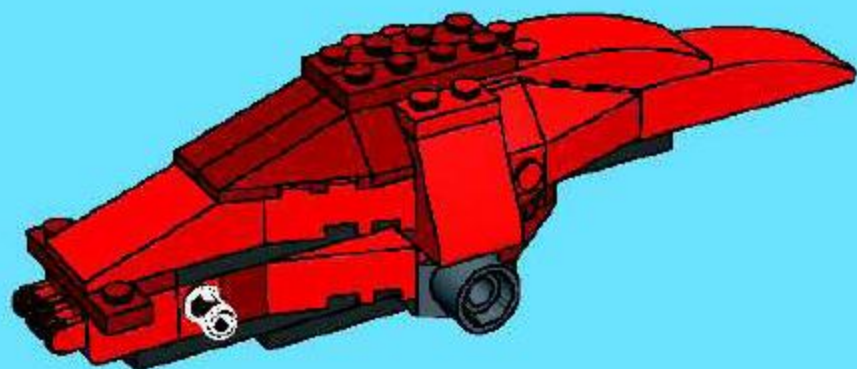



1

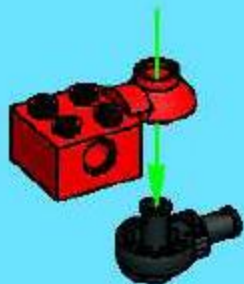

2



3



4



5



6



1

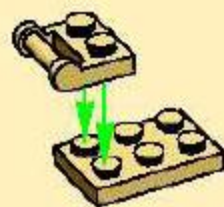

2



3



4



7



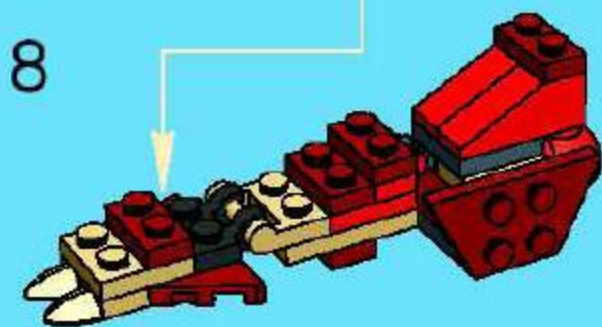
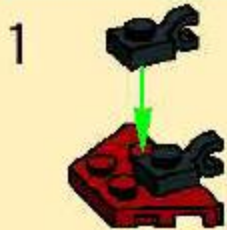

13

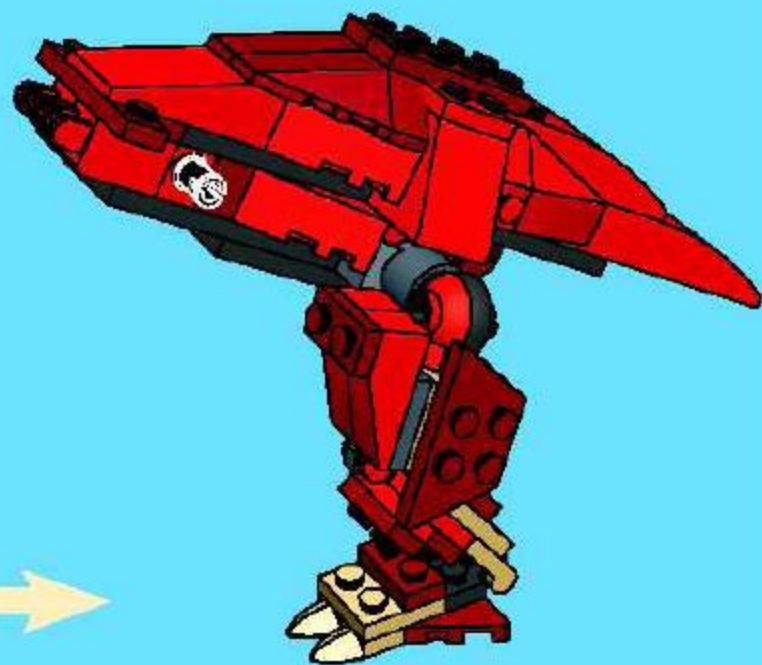



1



2



3



4



5



6



1

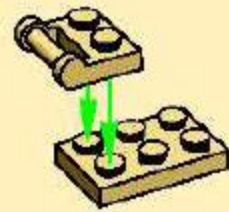

2



3



4



7



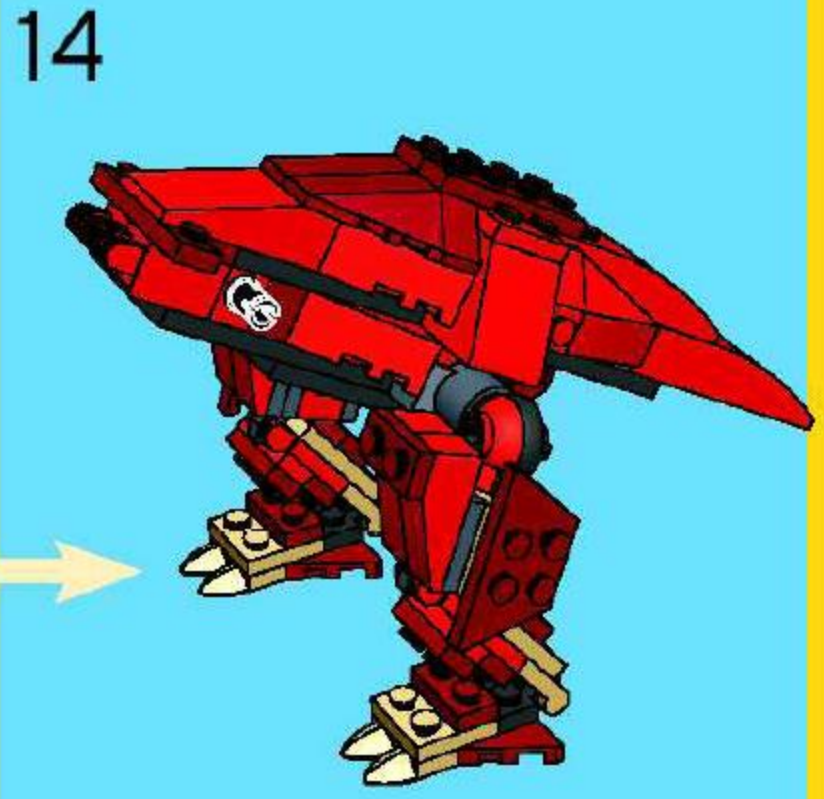
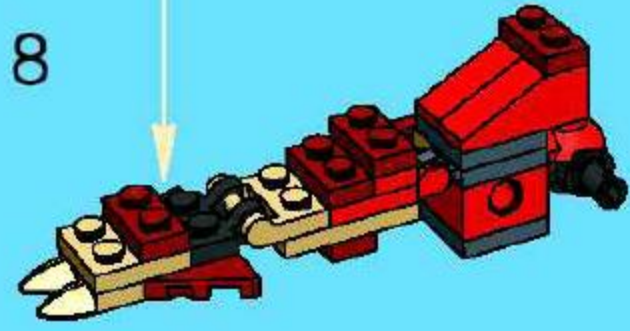
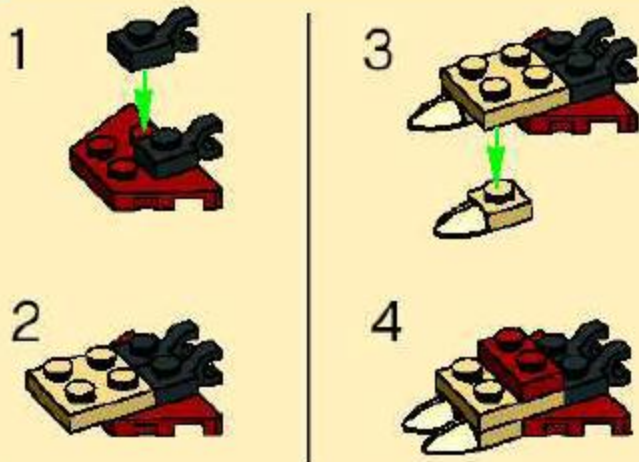

1



2

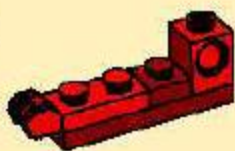

3



4

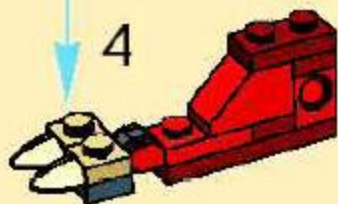

2x

15

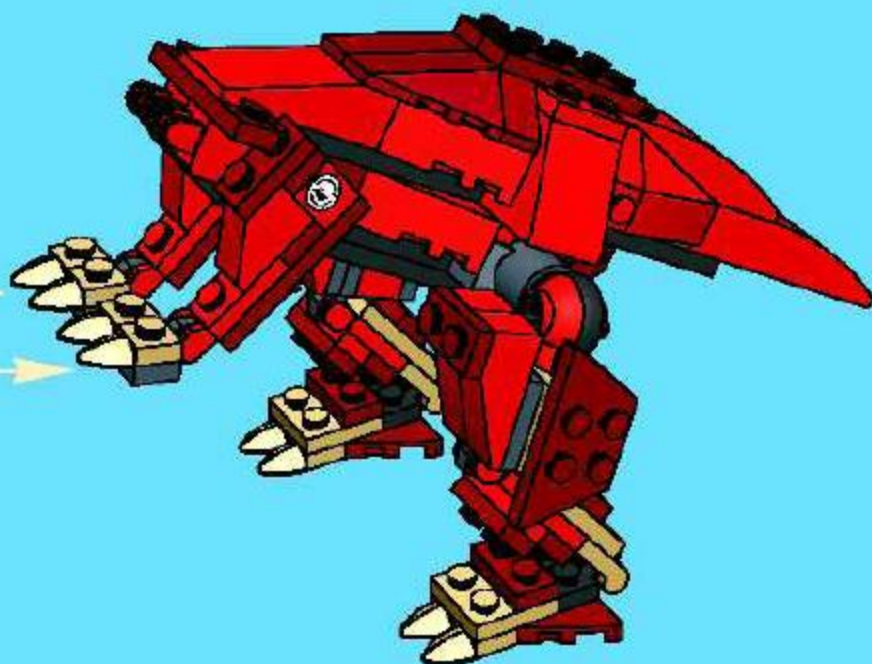

1



2



3



4



16

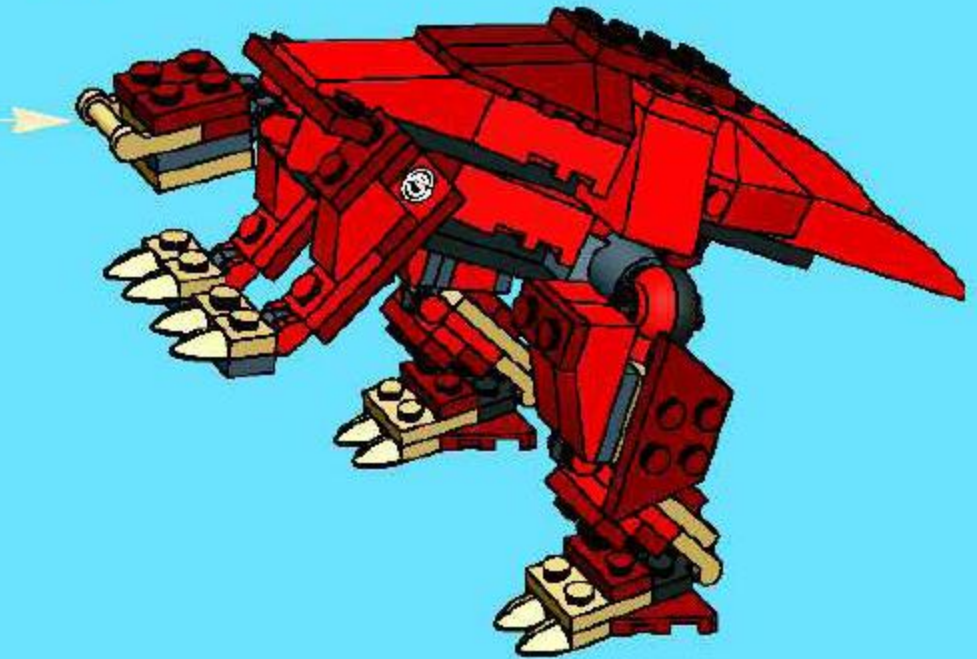

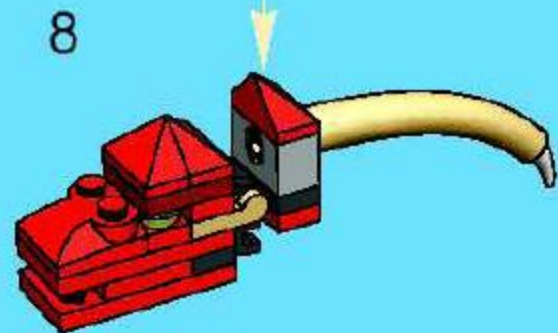
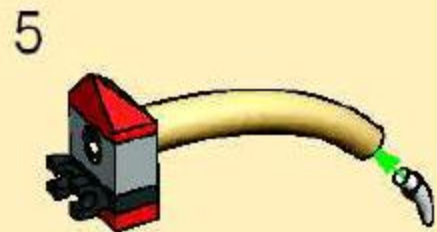
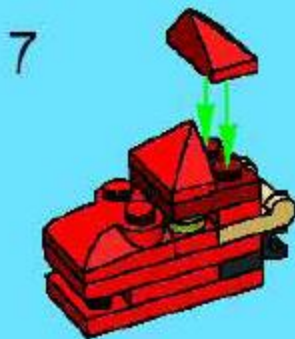

17

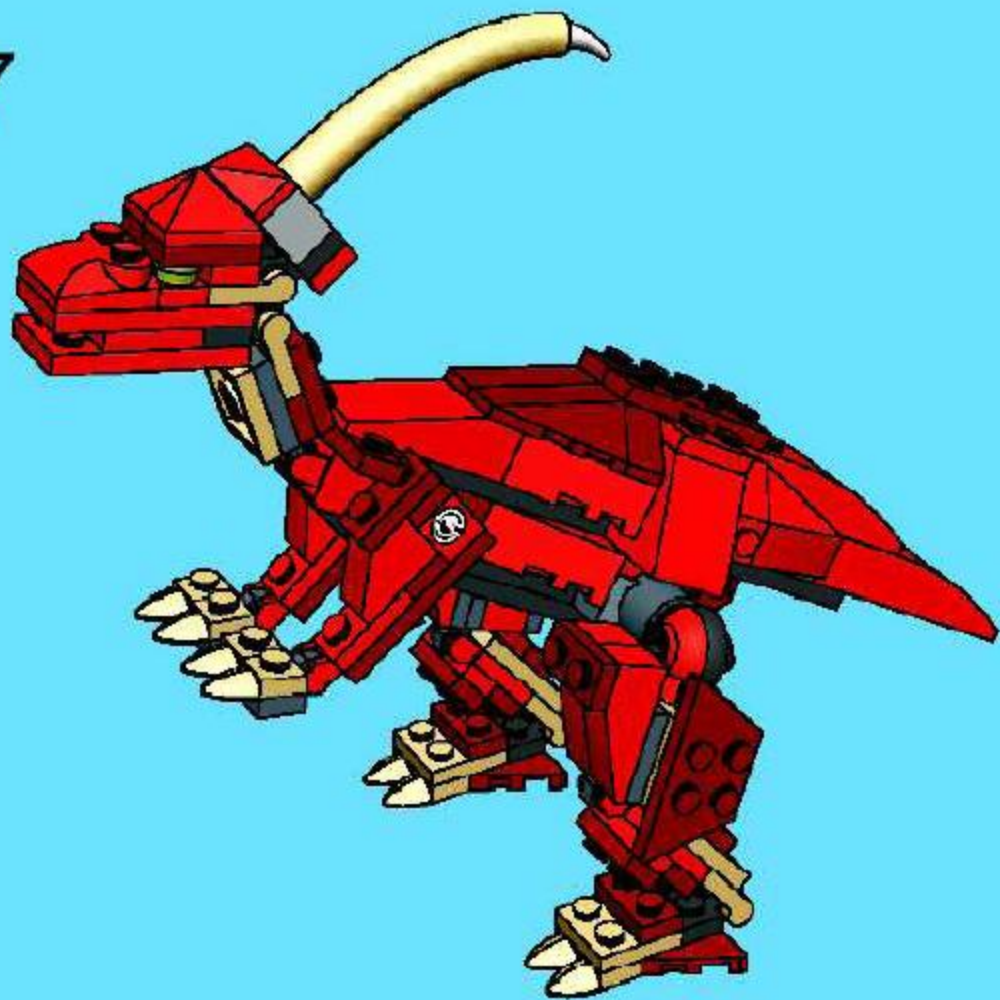



1

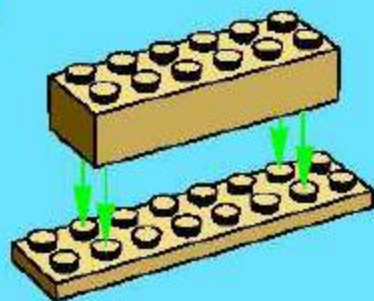

2

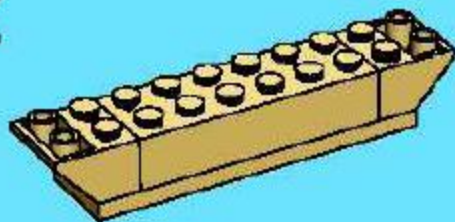

3

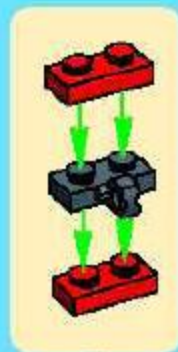
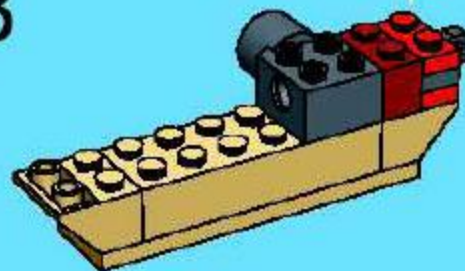

4



5

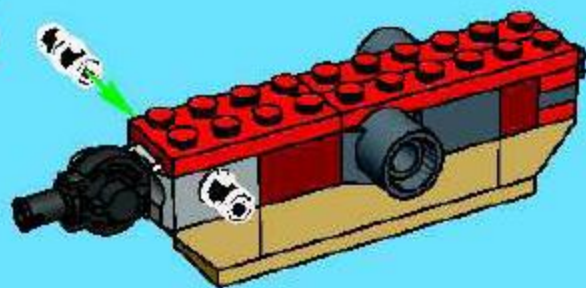

6



7

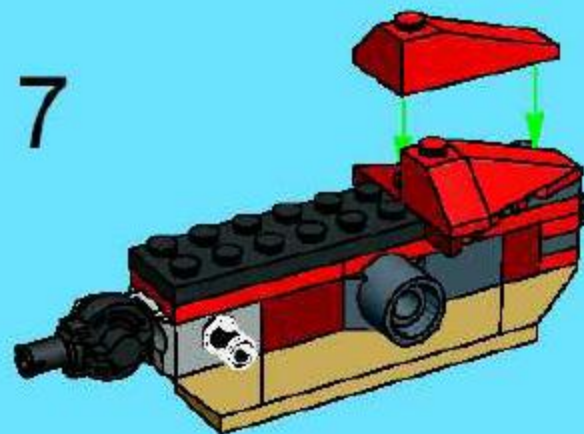

8

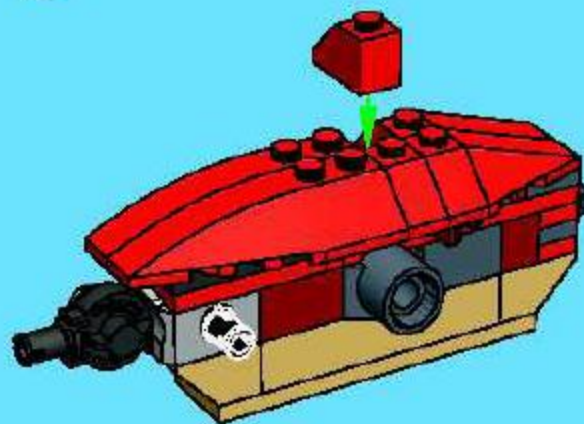

9

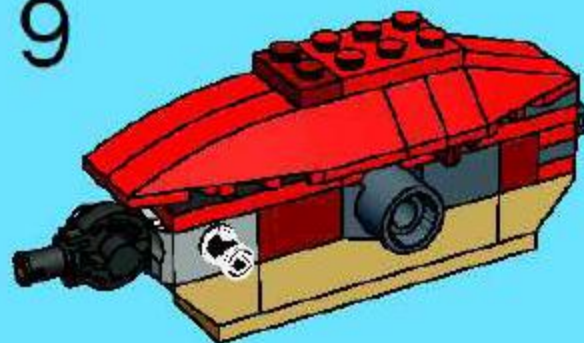

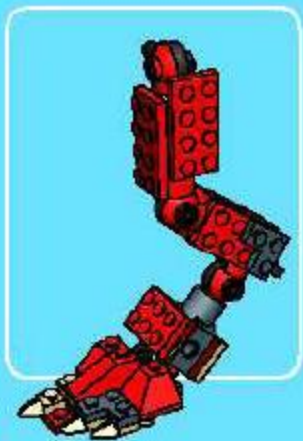

1



2



3



4



5



1

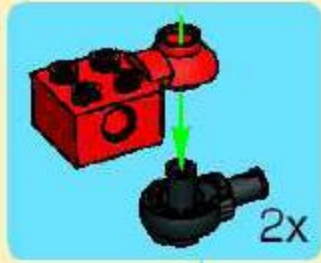

2



3



4



1



2



3



4



5



6

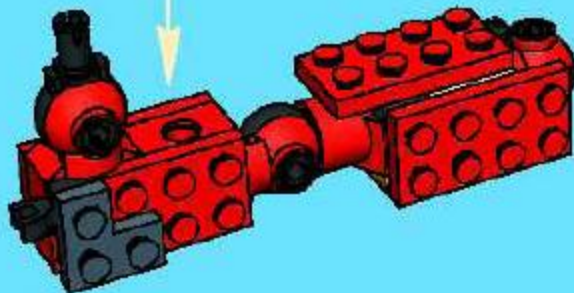

7

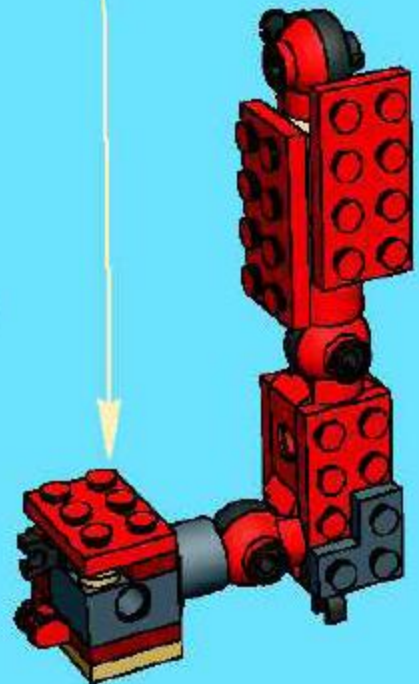

1

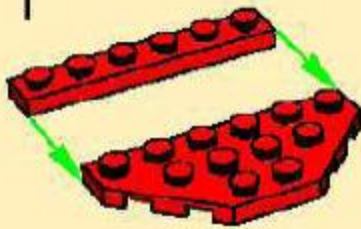

2



3



4



5

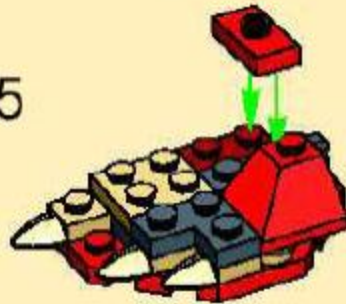

6

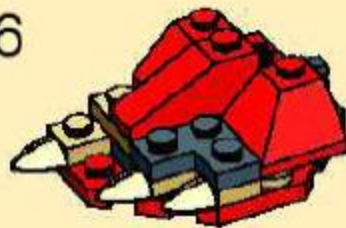

8

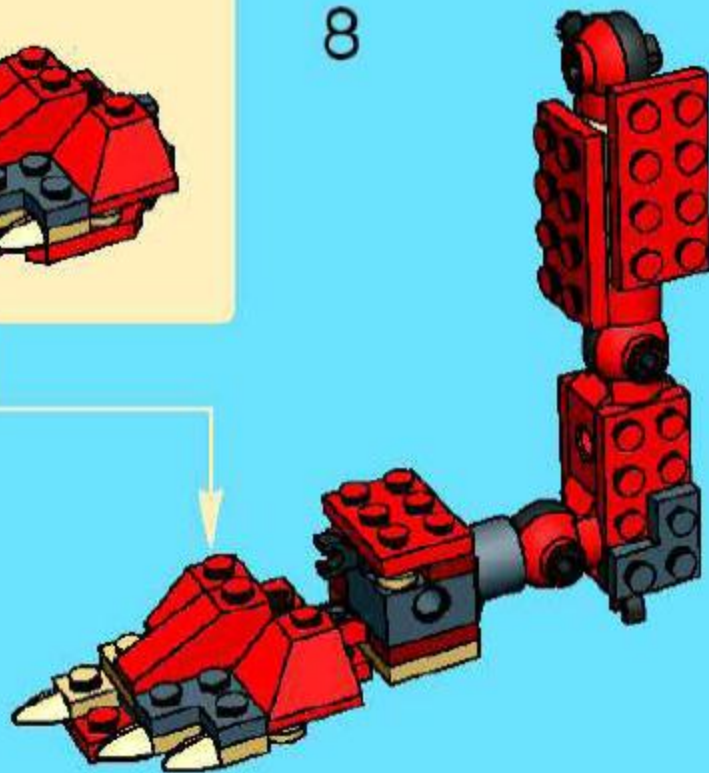

9

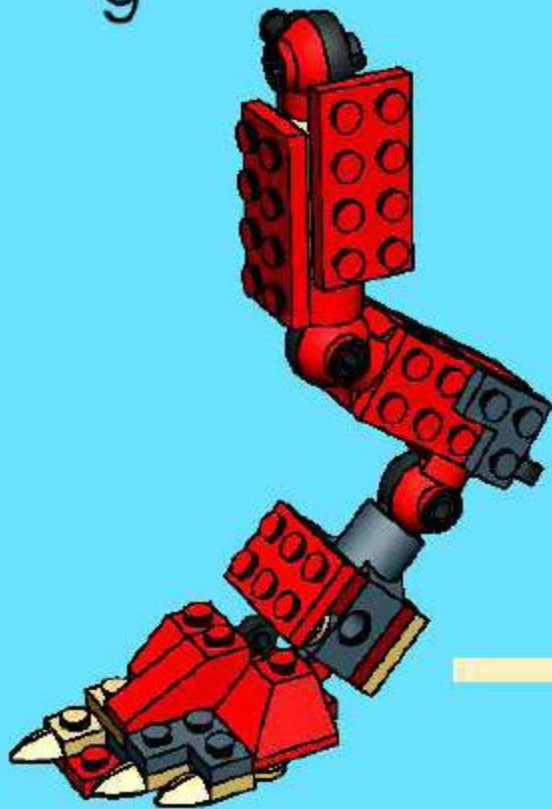

10

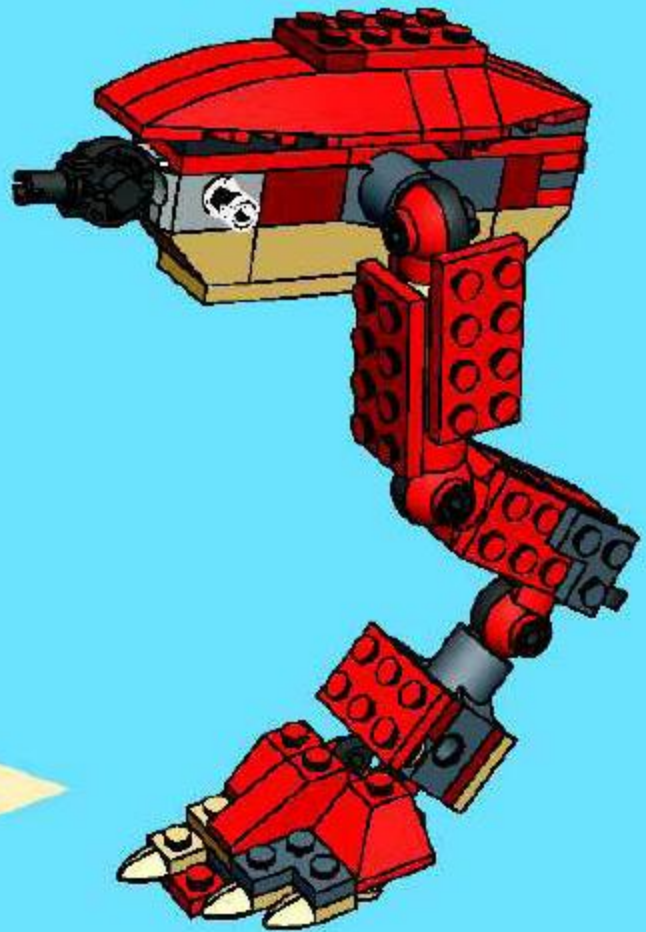

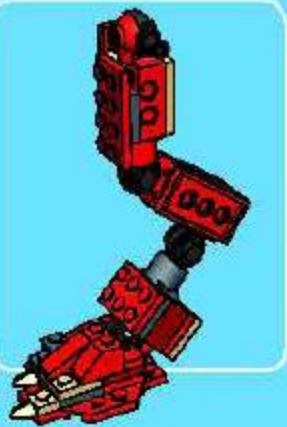

1



2



3

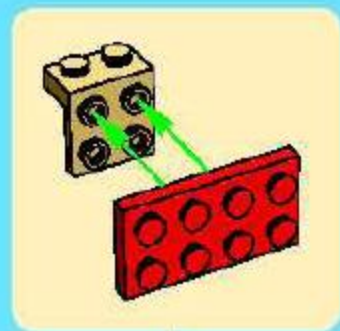

4



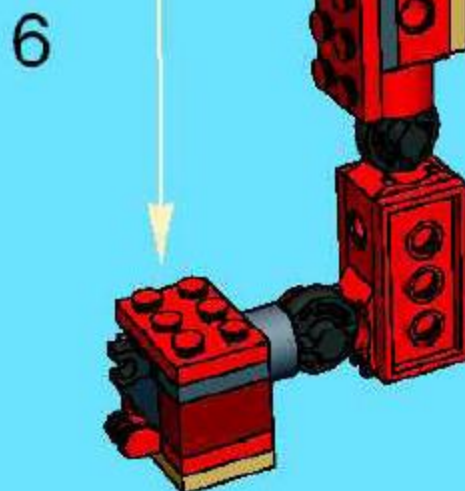
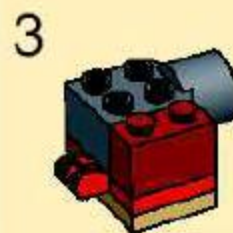
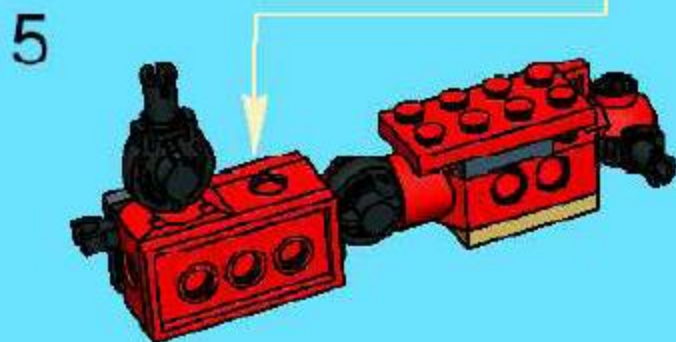
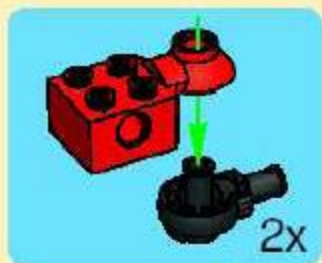

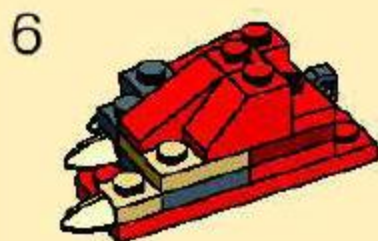
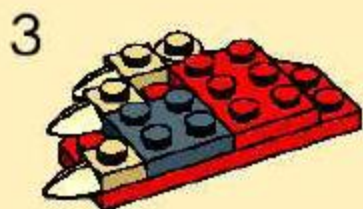
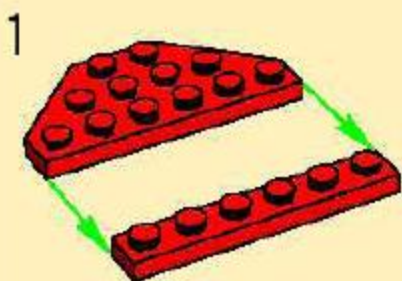

7

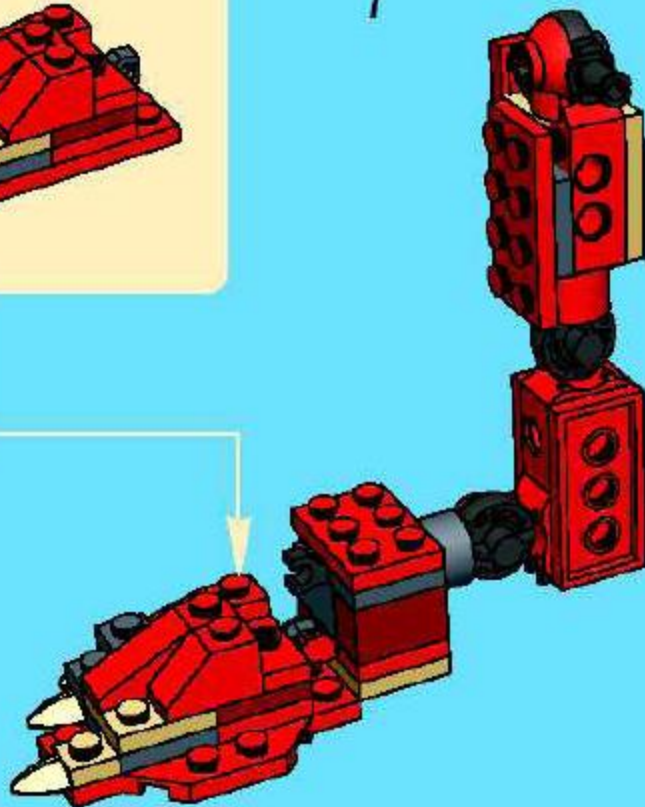

8

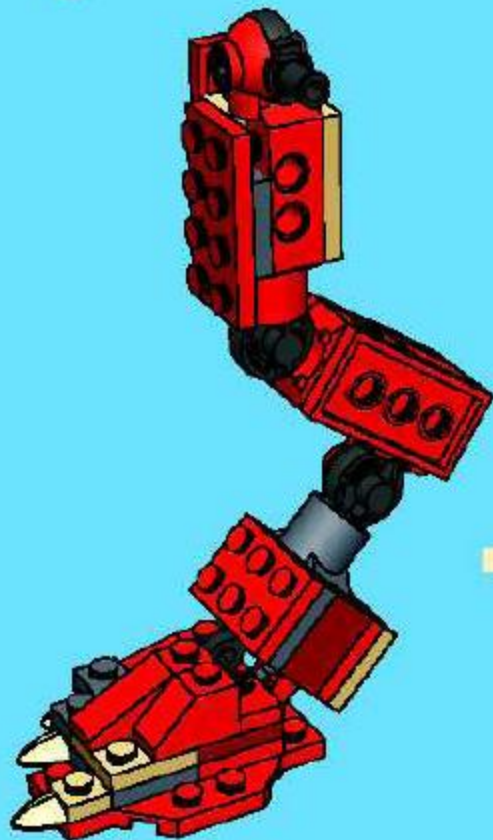

11

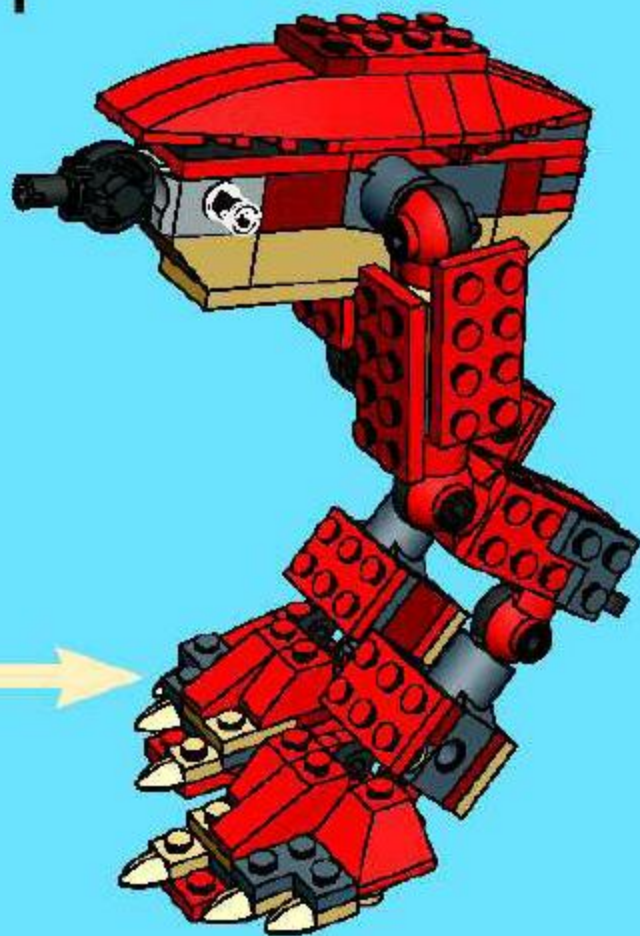

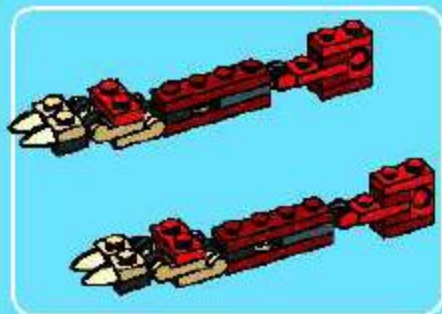

1

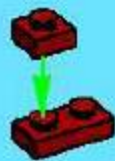

2



3



4



1

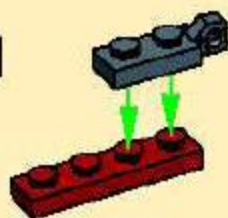

2

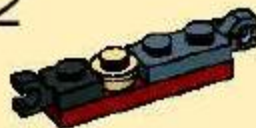

3



5



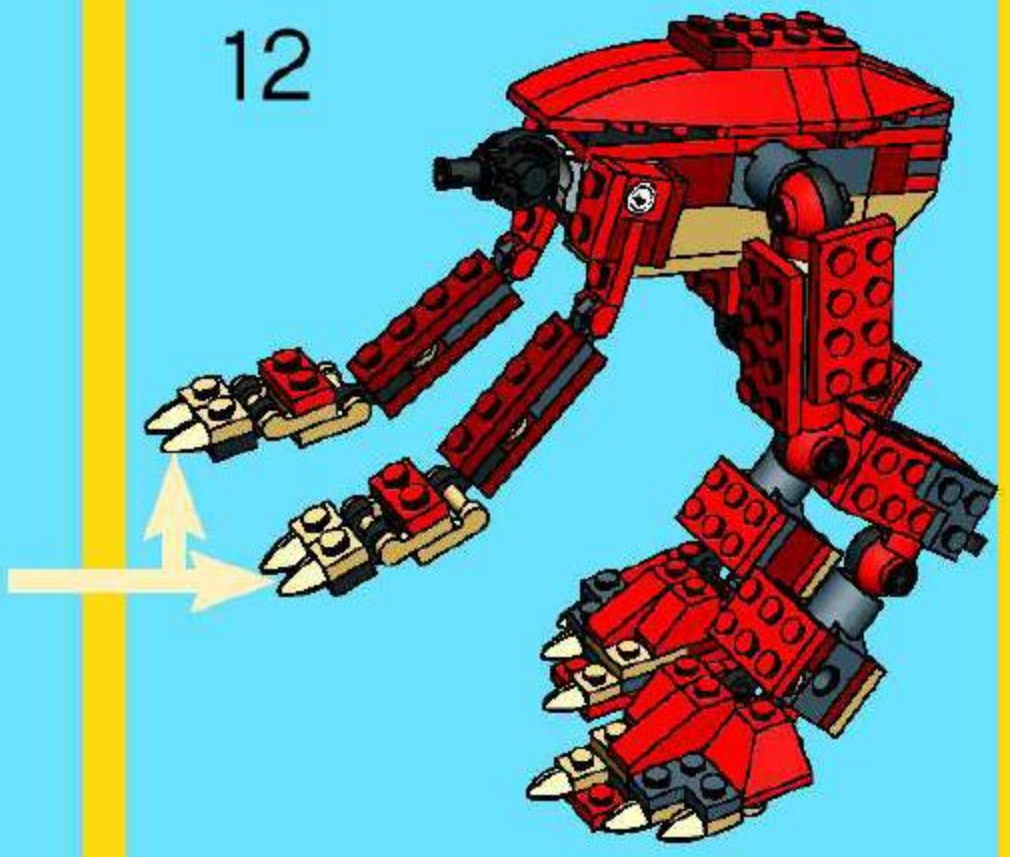
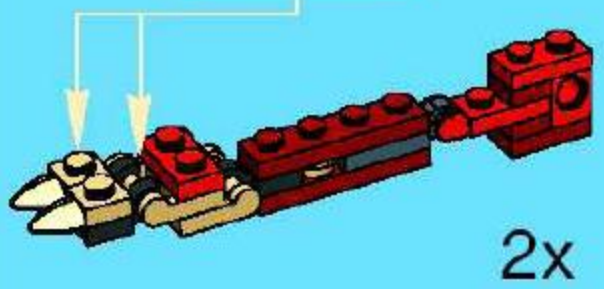
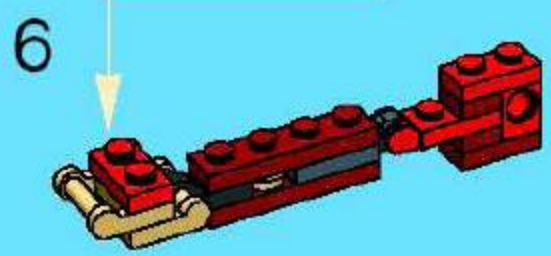
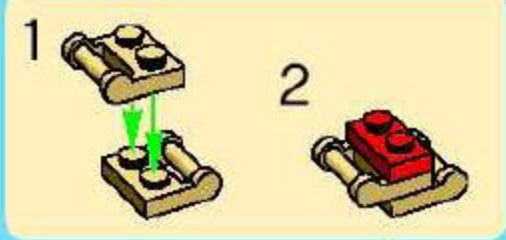

1

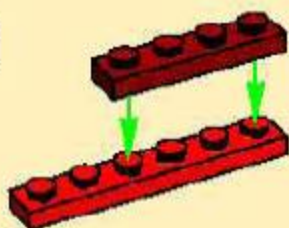

2

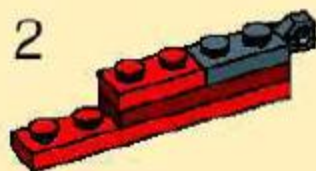

3

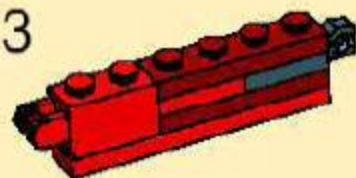

4

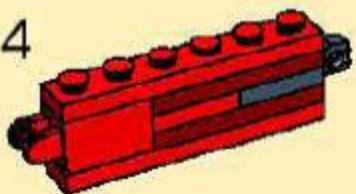

13

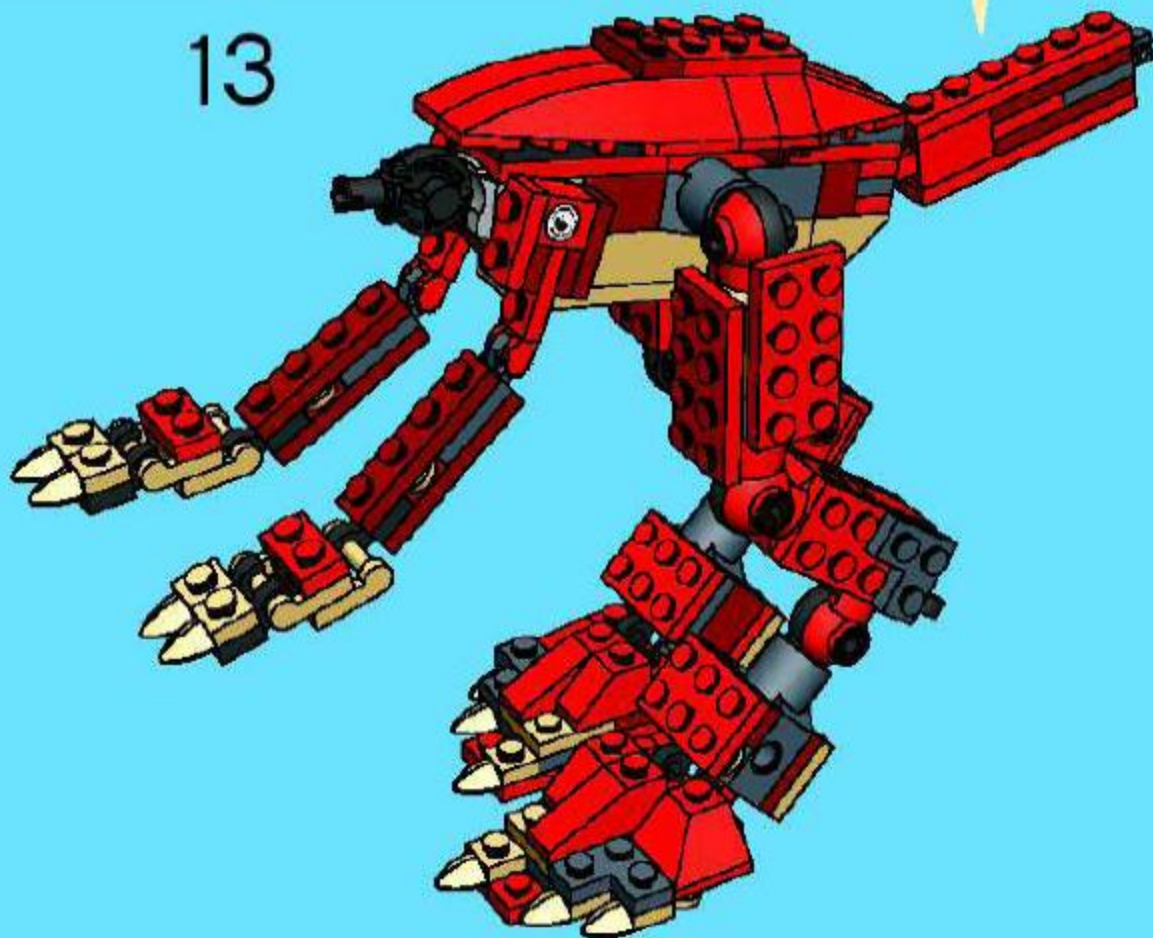

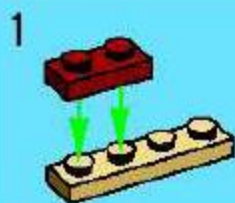
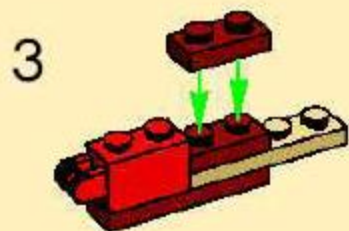

14

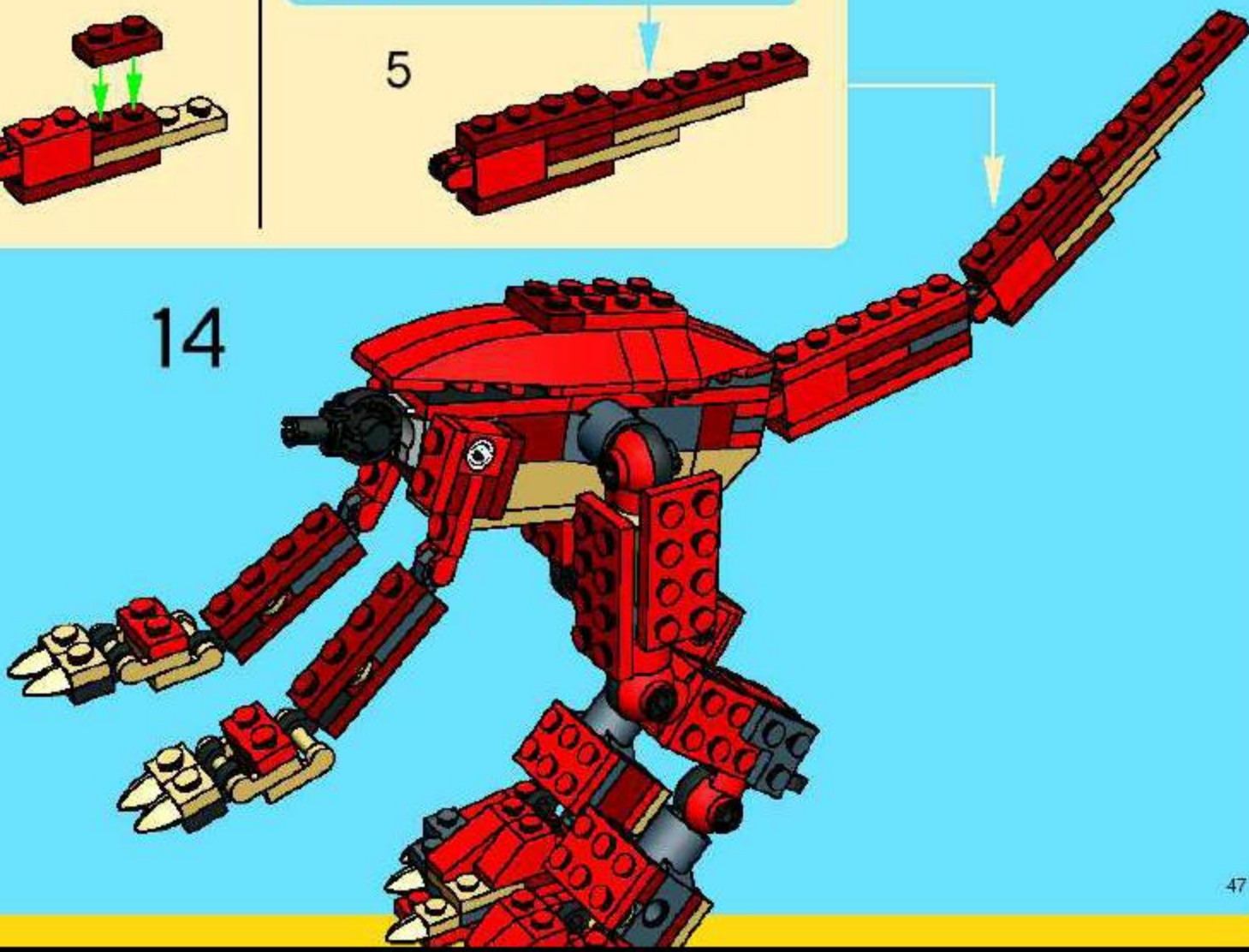

1



2



3



15

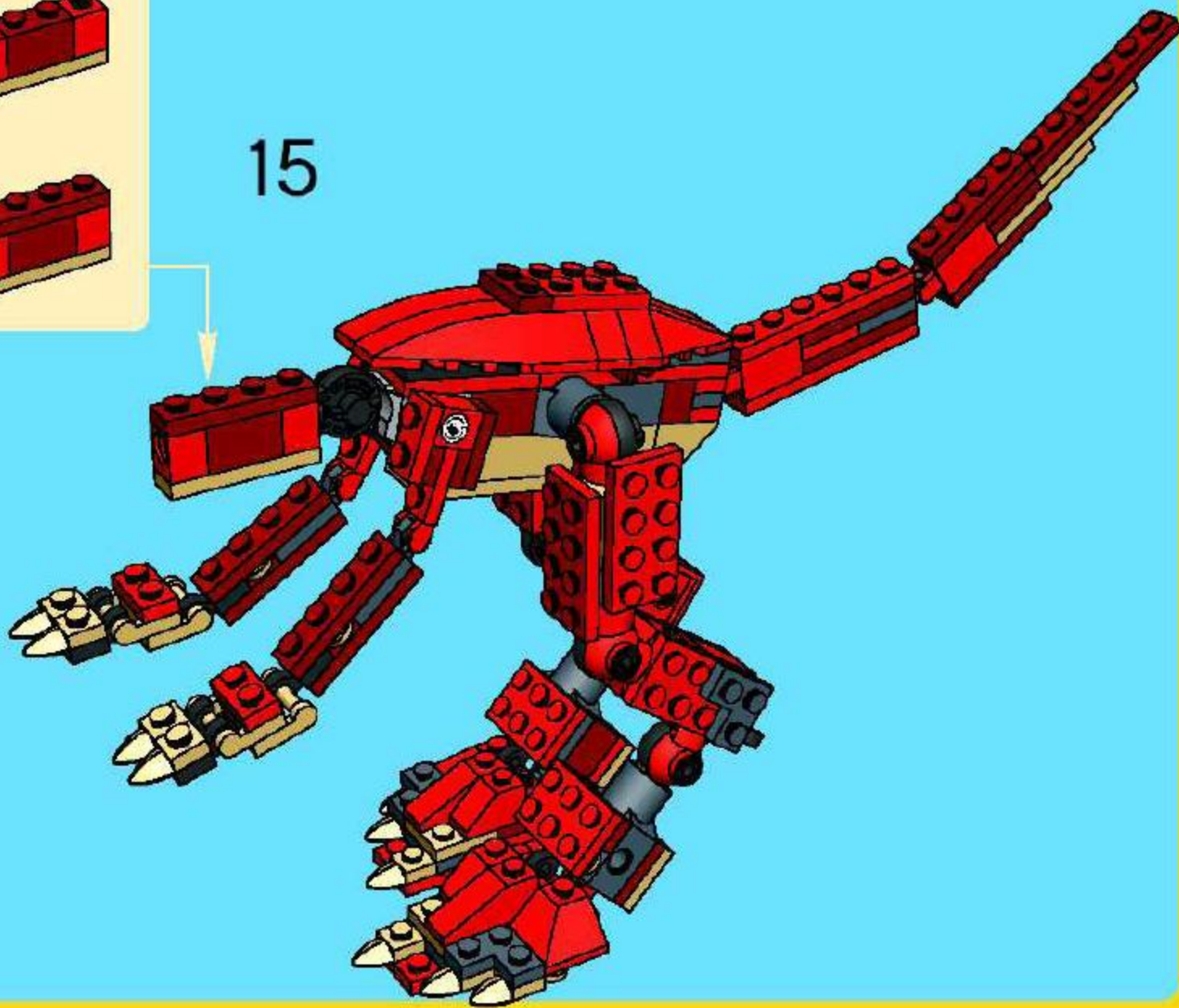



1

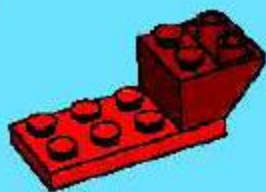

2



3

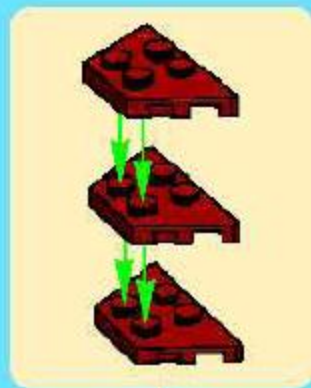

4





5

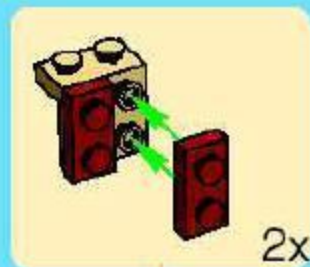

2x

6



7



8



16





1



2



3



4



5

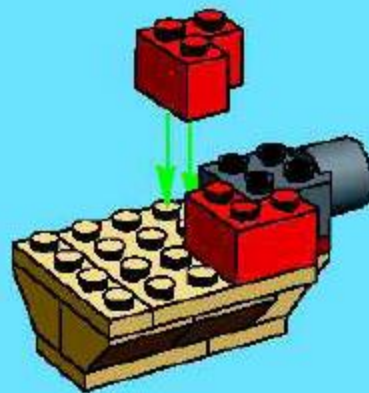

6



7



8



9

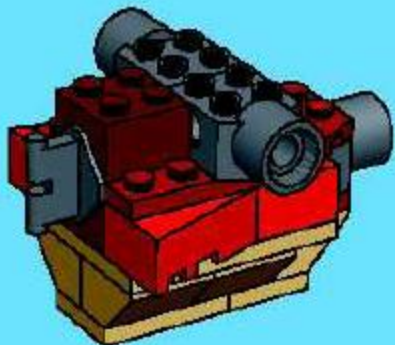

10

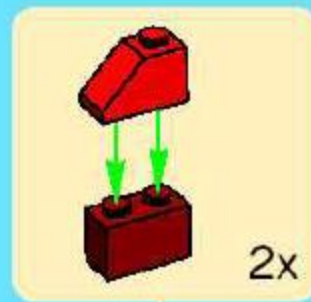
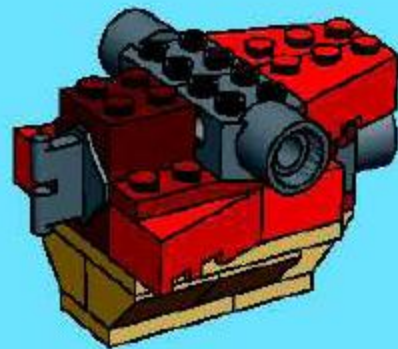

11

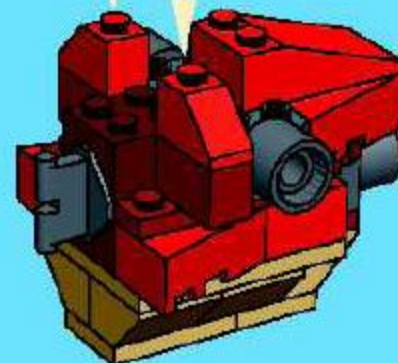

12

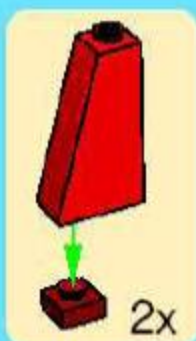
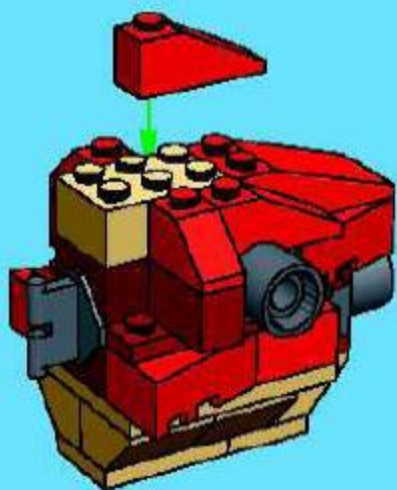

13

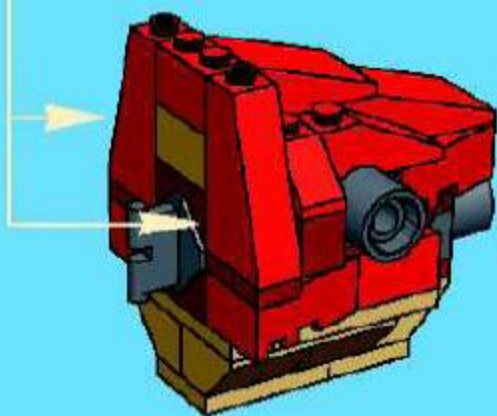

14

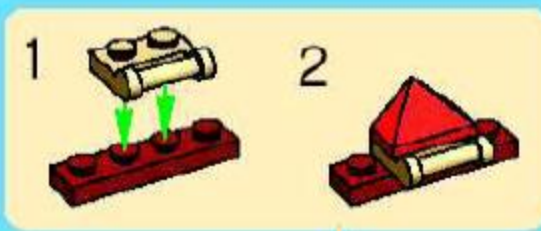

15

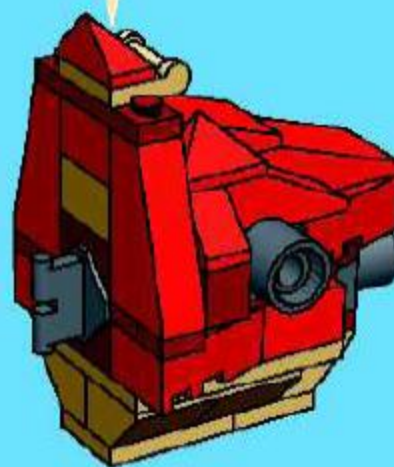

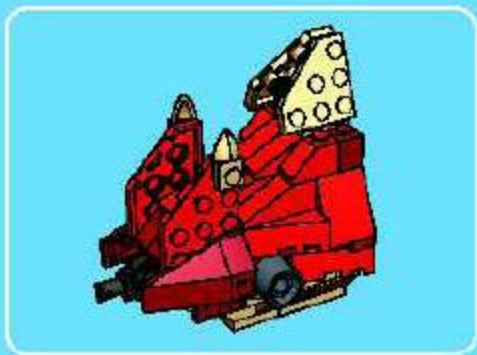

1

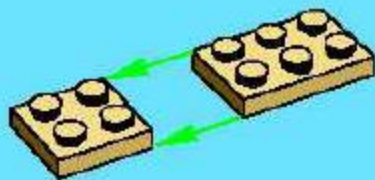

2



3

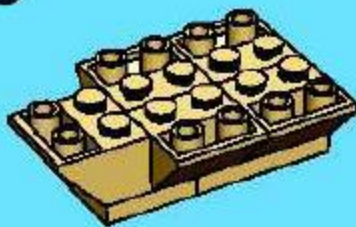

4

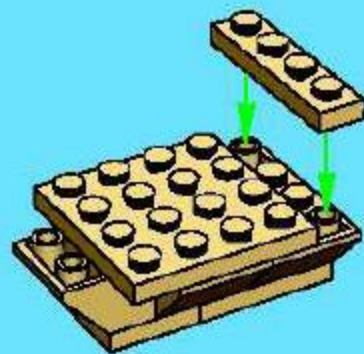

5

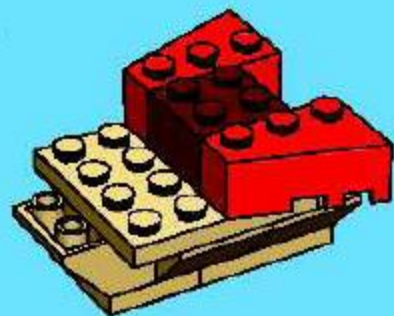

6

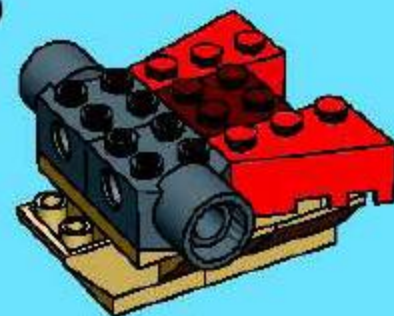

7



8



1



2



3

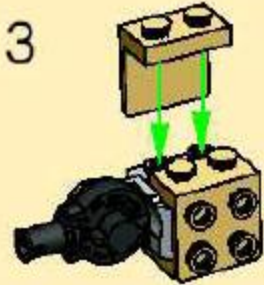

9

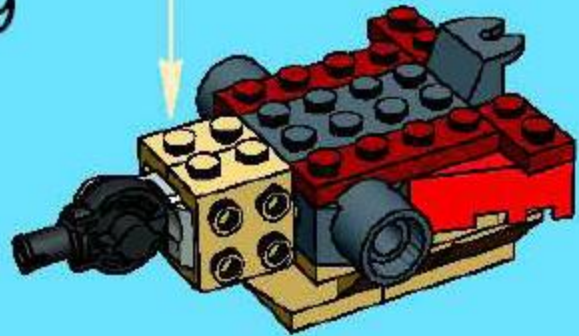

10

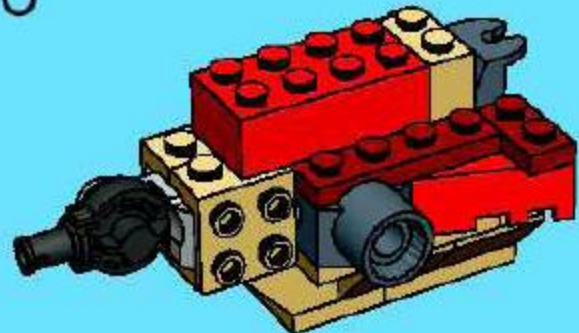

11

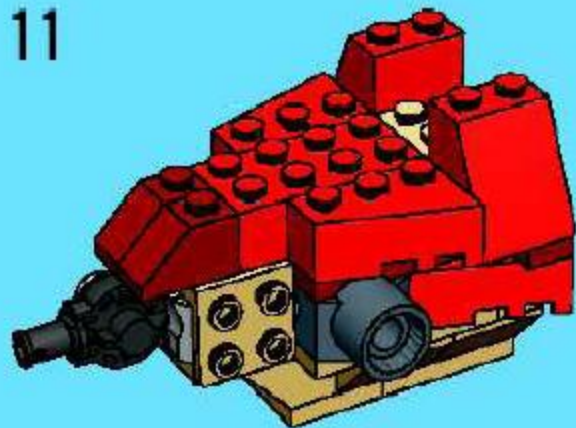

13

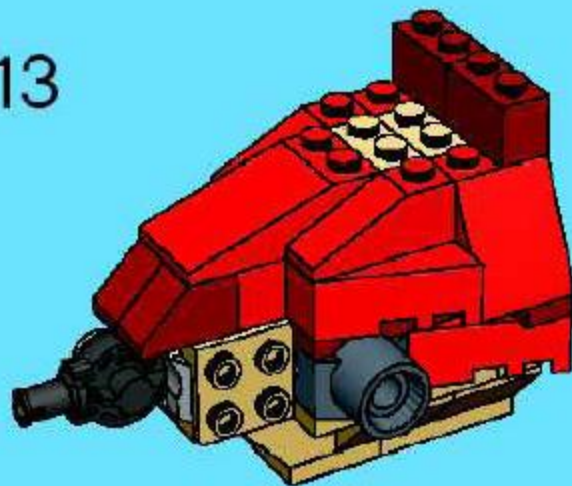

12

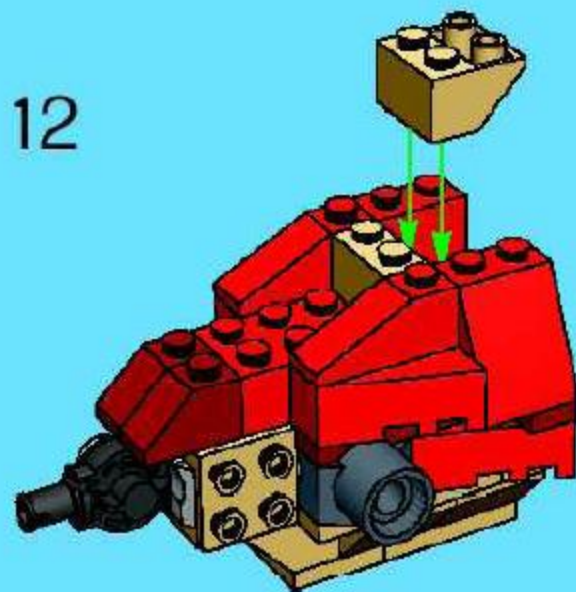

14

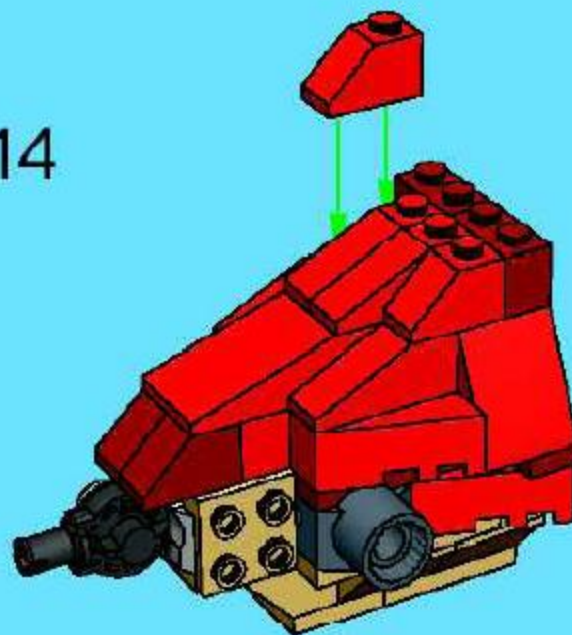



15

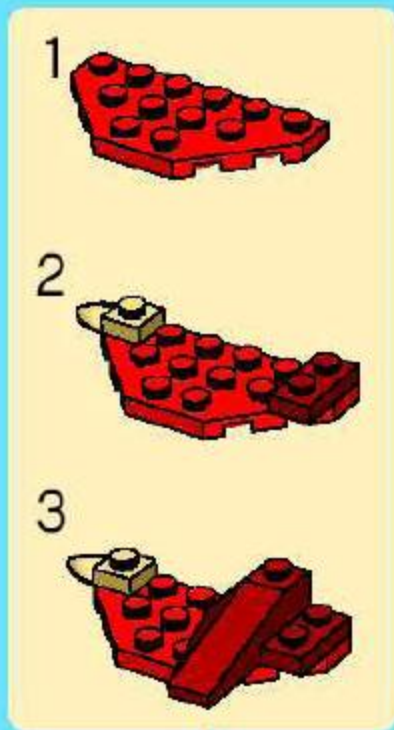
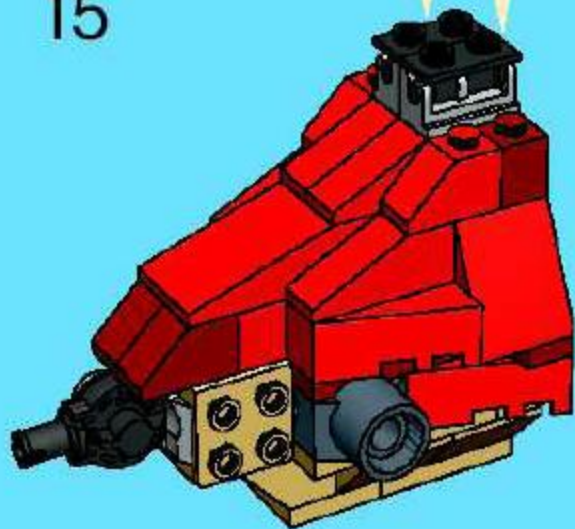

16

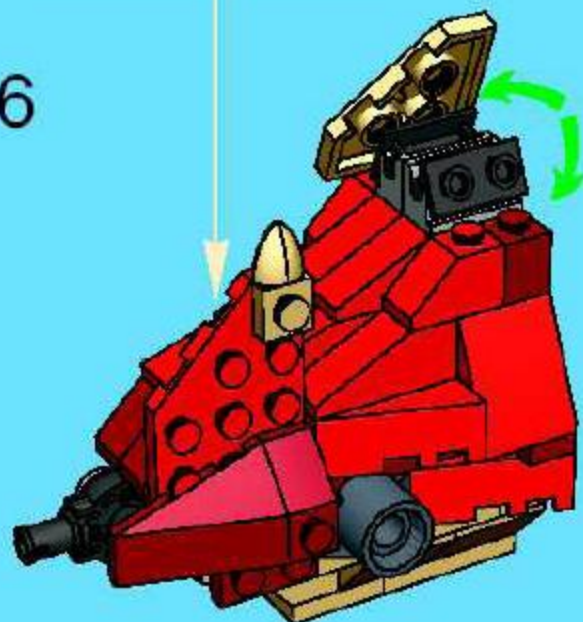

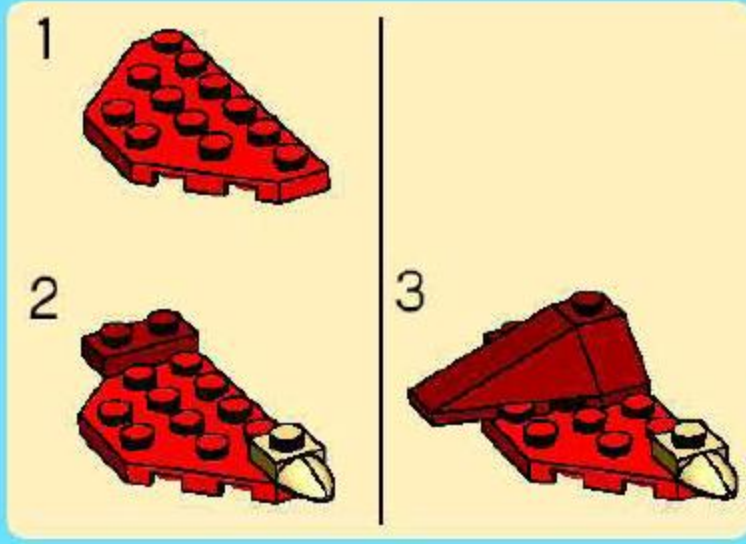

17

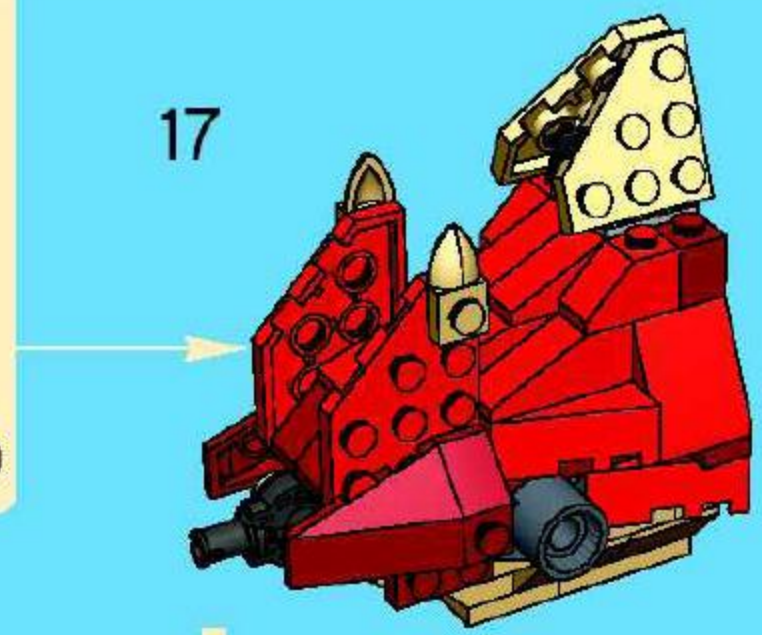

16

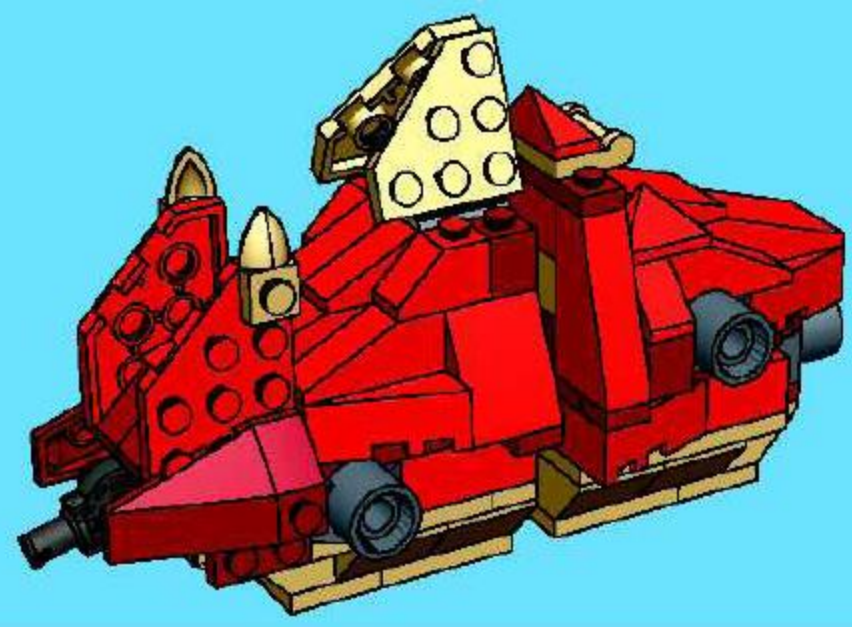



1



2



3



4



5

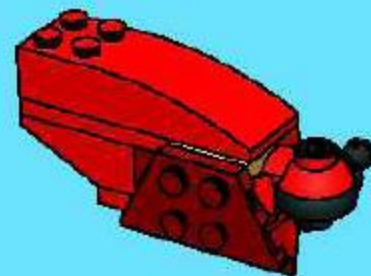

6



17

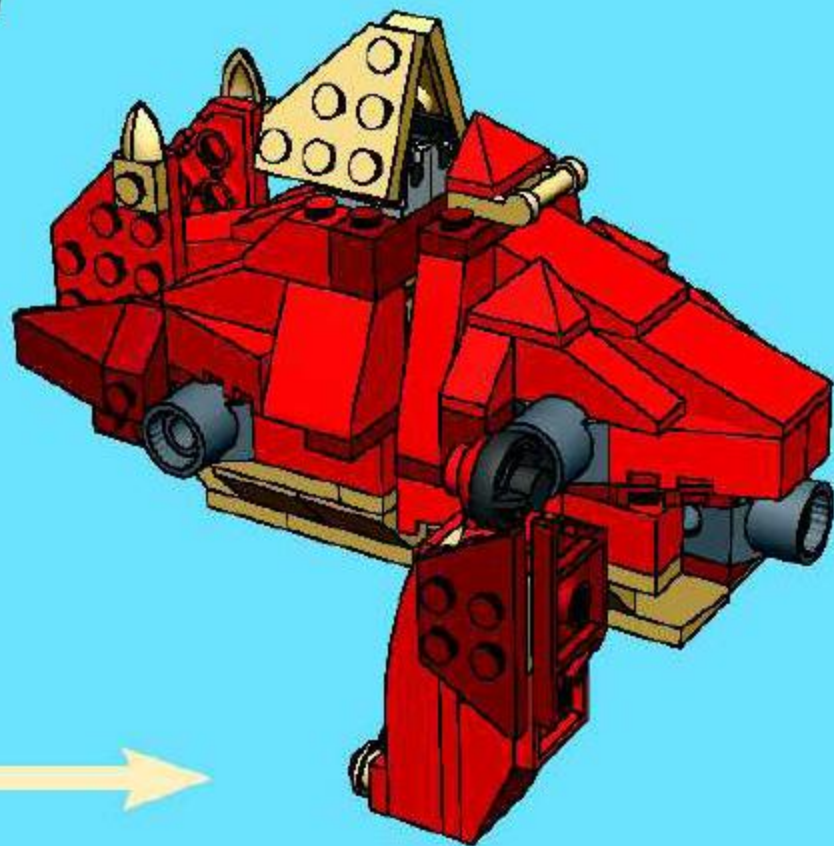



1



2



3



4

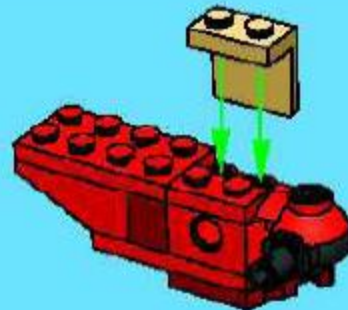

5



6

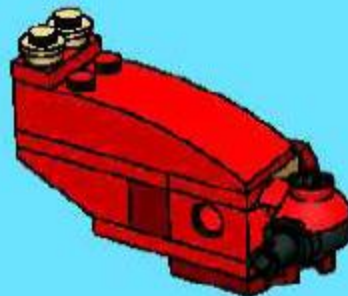

18

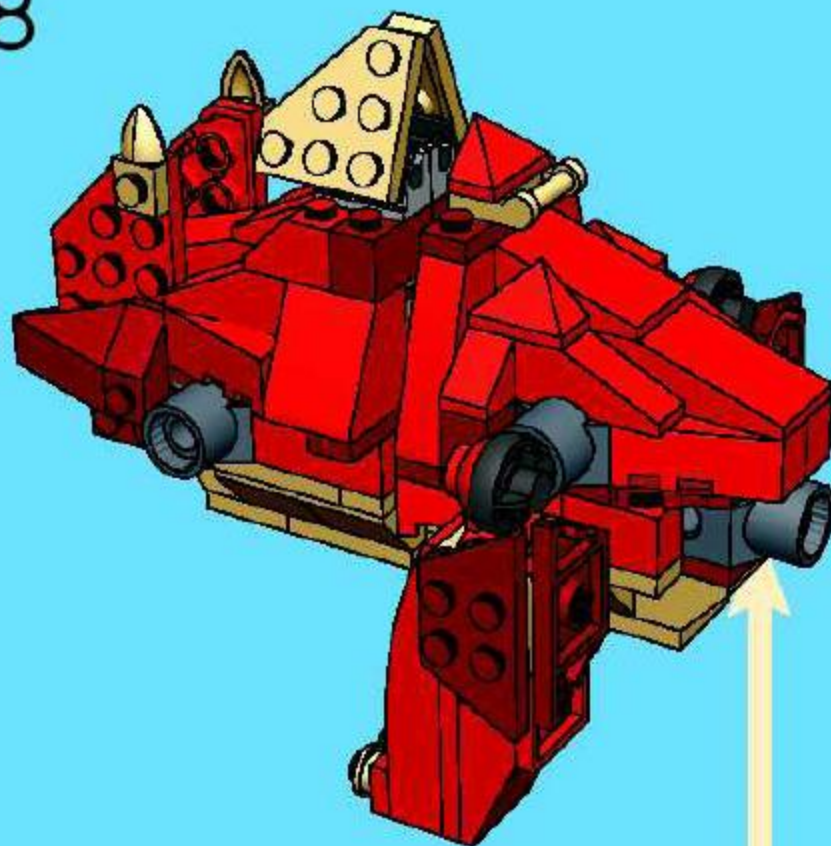



1



2



3



4



2x

19

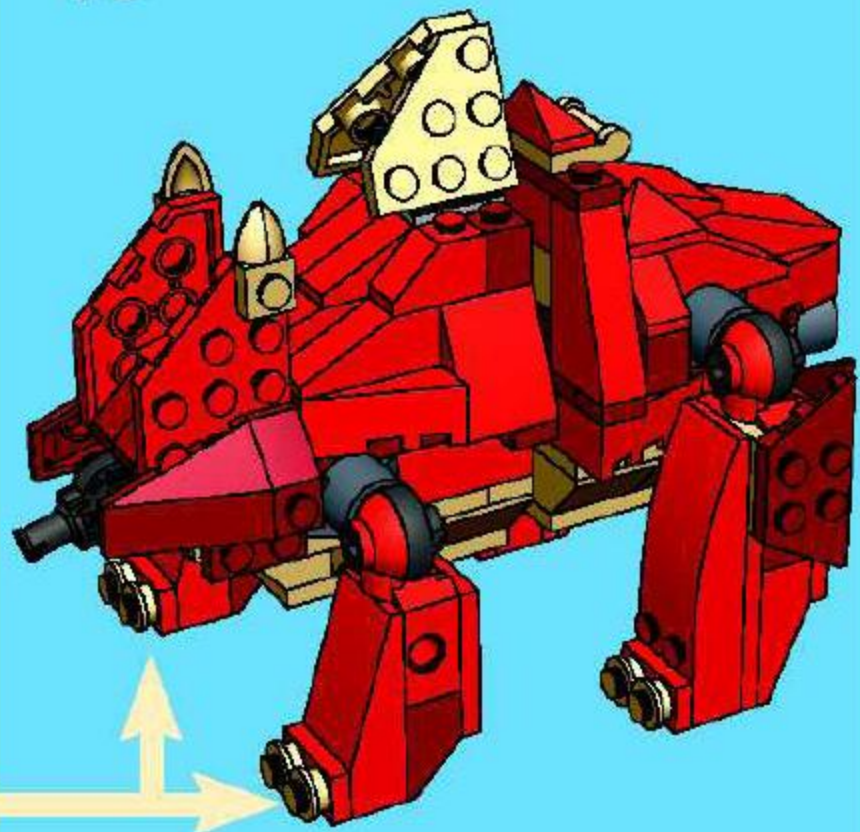



1



2



3



4



5



6



7



8



20

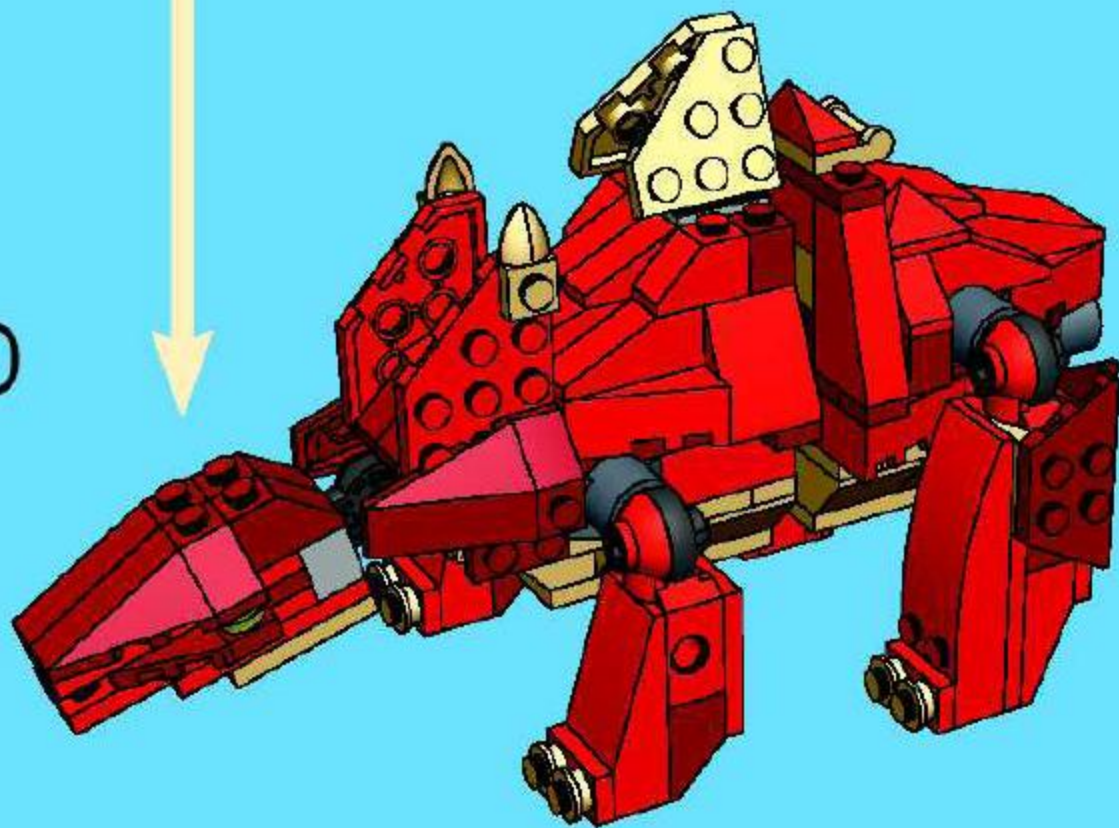

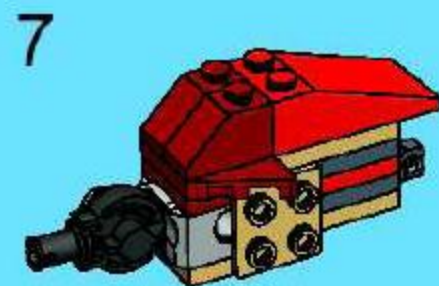
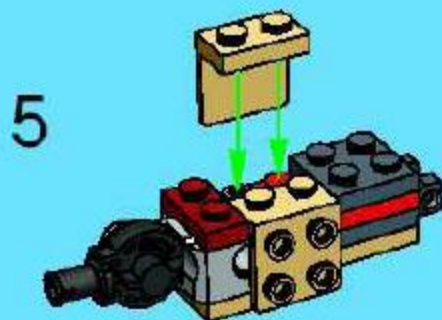
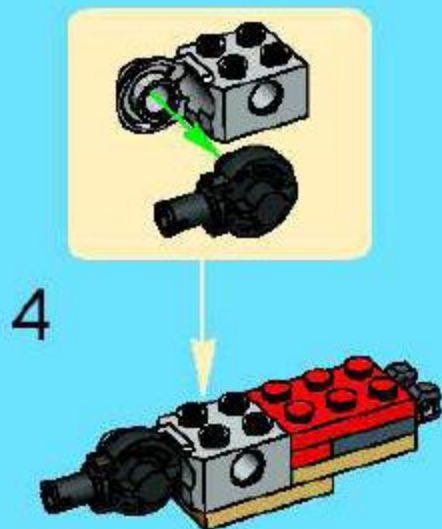
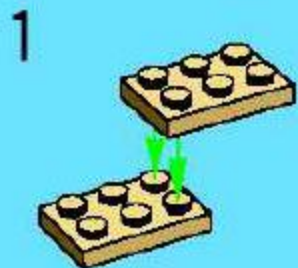

21

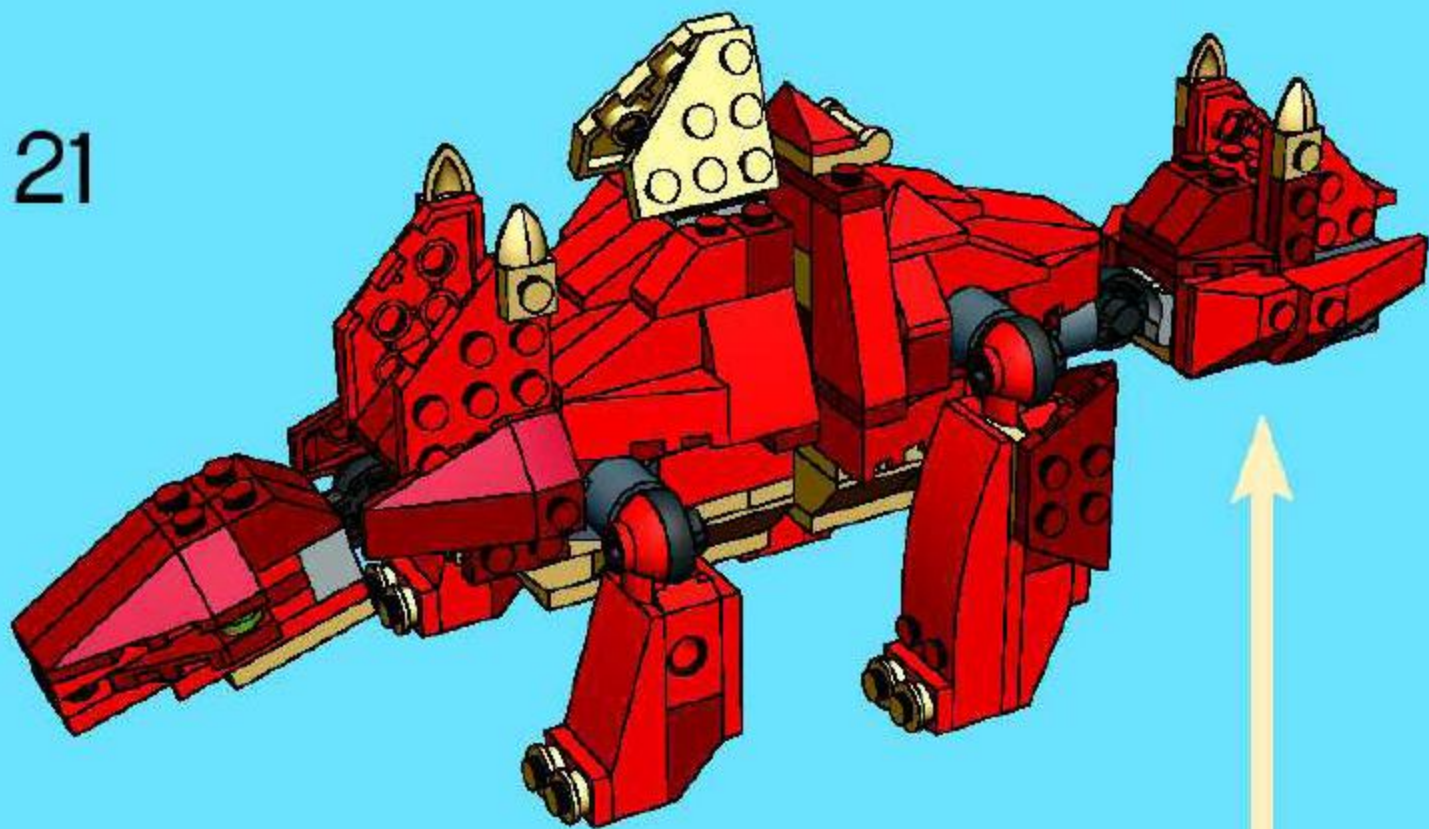

1

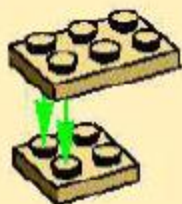

2



3



4

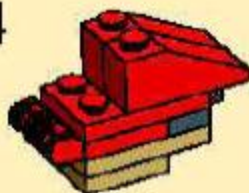

5



6



22

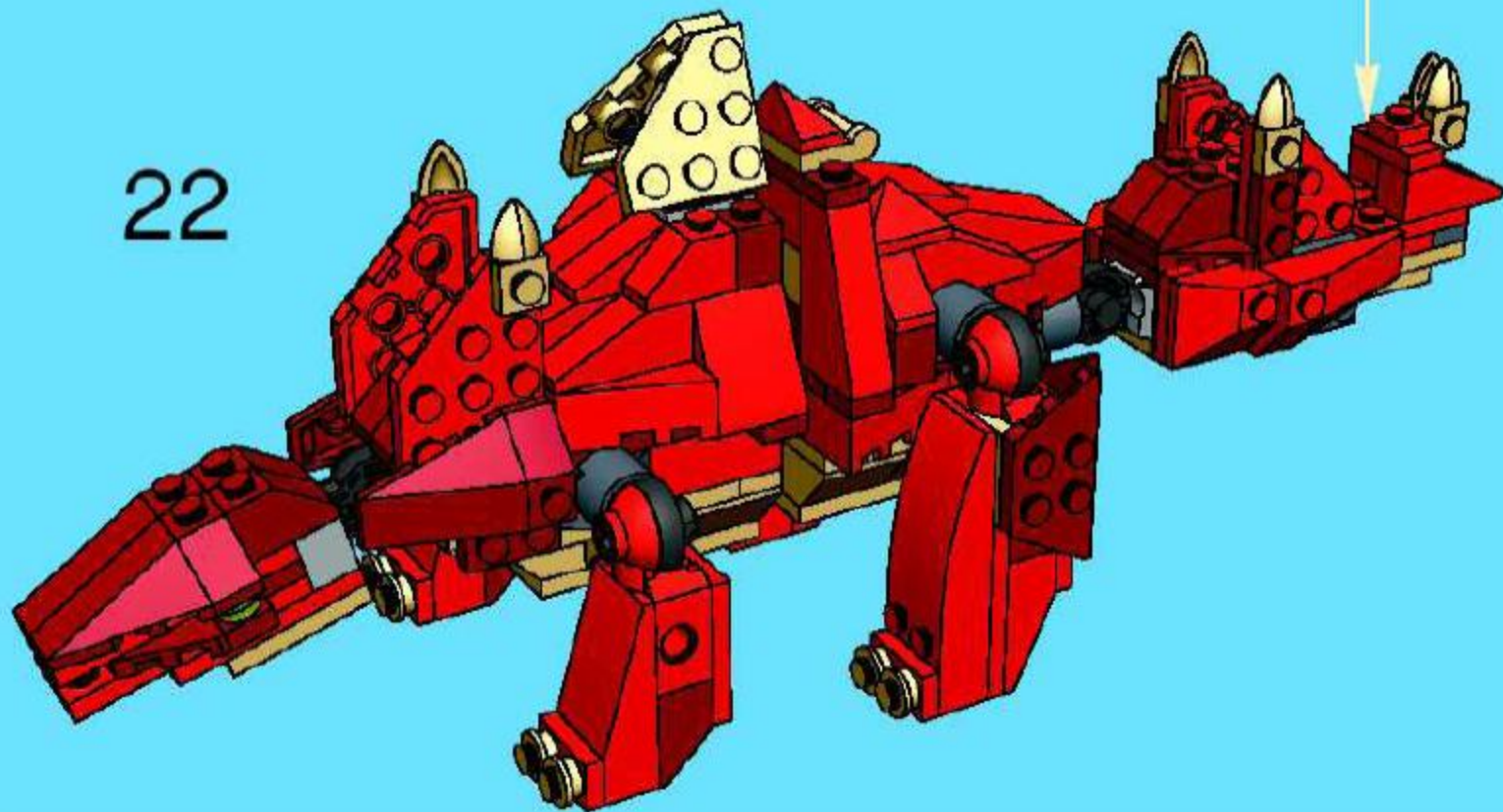



23

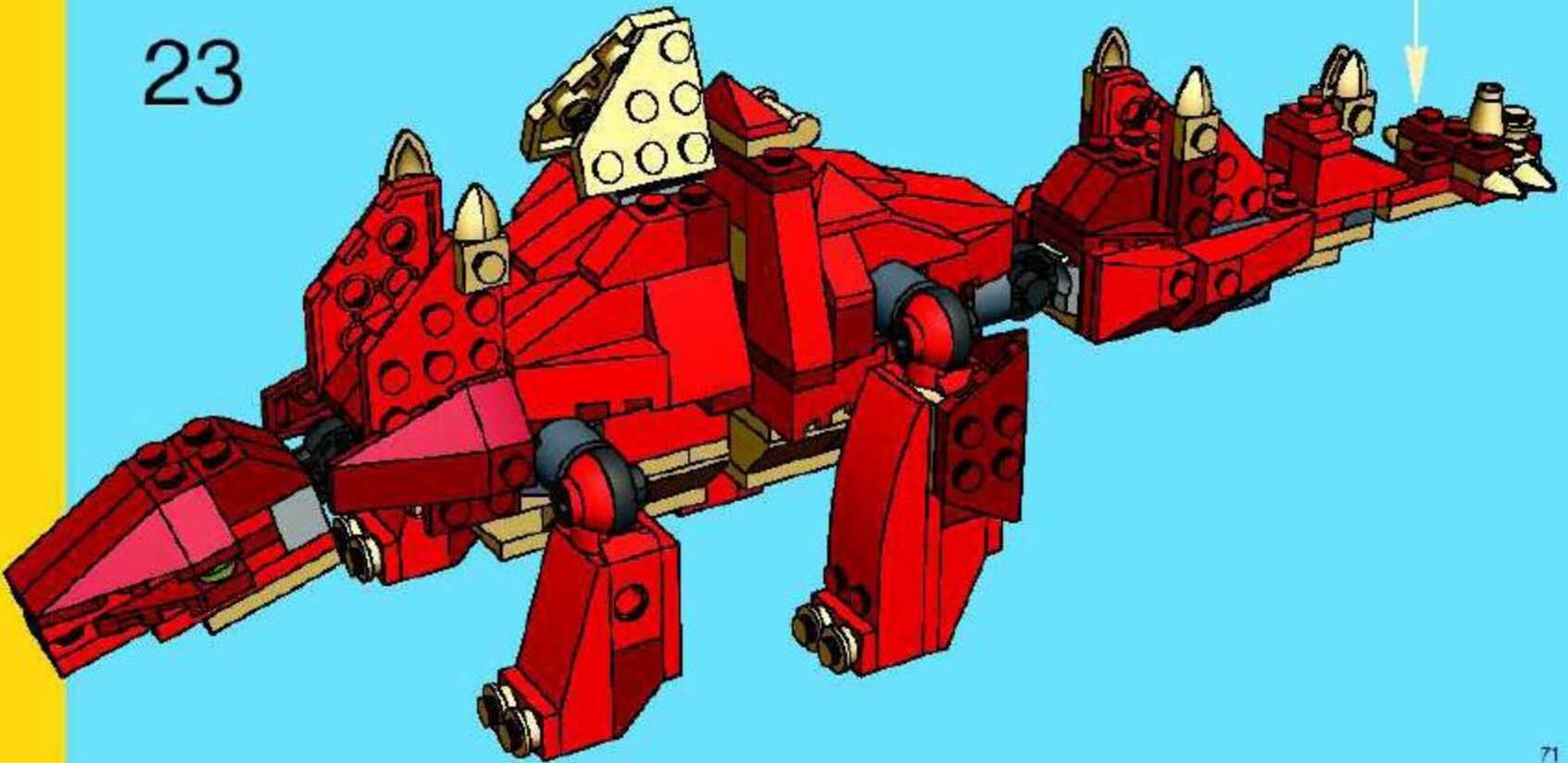

24

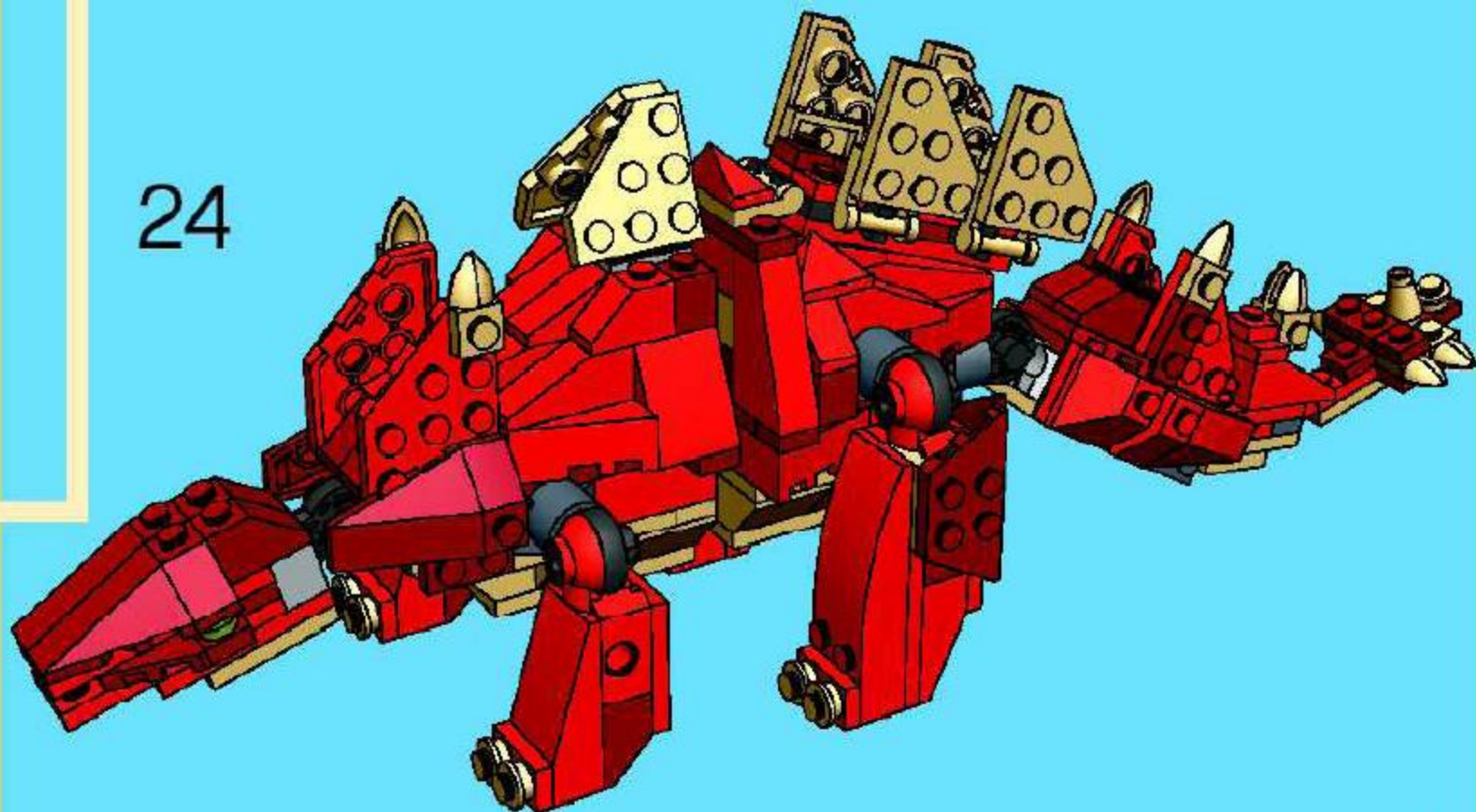

34



52



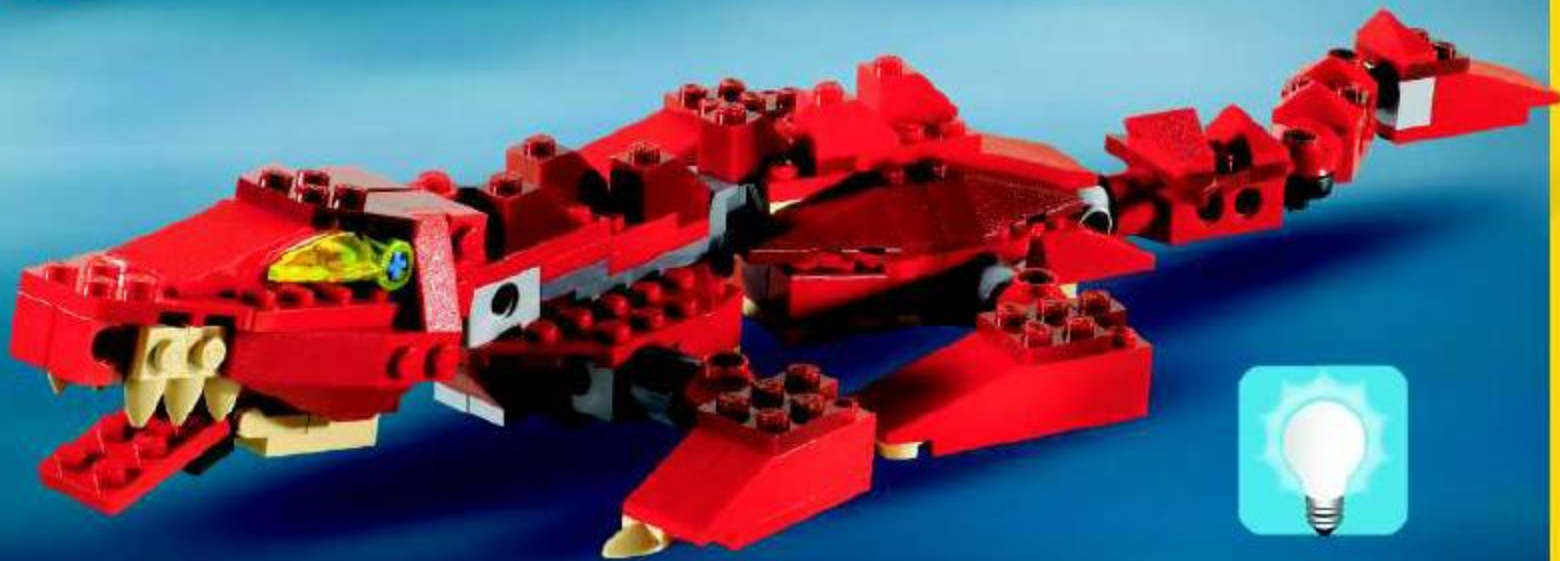

LEGO

CREATOR

4417



4416



4415



4418



©2006 The LEGO Group.



4891



CREATOR

6-12

4892 - 2

4296272



Ideas



Instructions



Advanced Build
Profimodell
Construction avancée
Costruzione avanzata
Geavanceerd bouwen
Construcción avanzada
Byg avanceret
Täiaväli rakentajalle
Bygg avancerat
Construção Avançada
Εξελιγμένες Κατασκευές
Profiknek



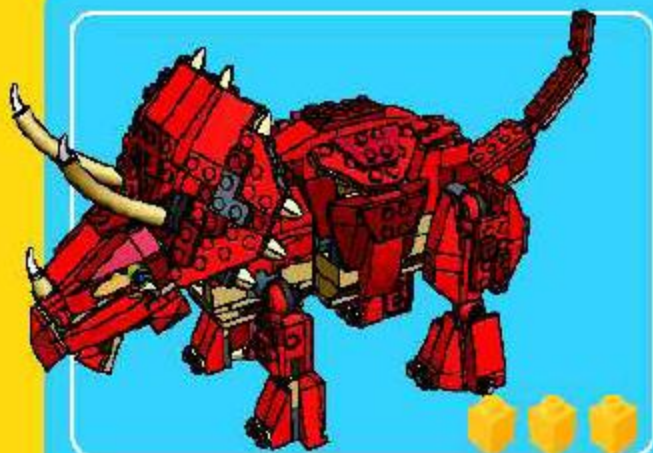

1

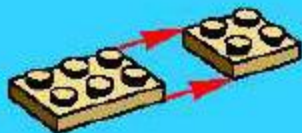

2



3



4

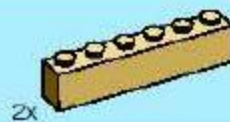

5

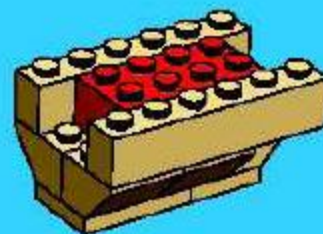



1x

6



1x

7



2x

8



1x



2x

9



2x



2x

10



2x



2x

11

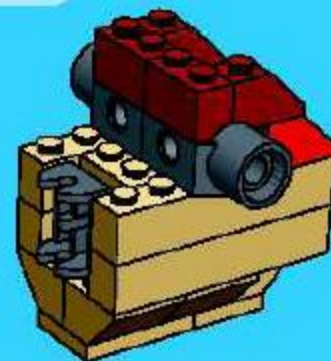

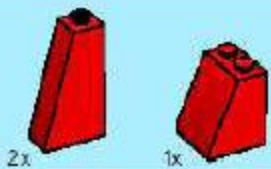

12



13

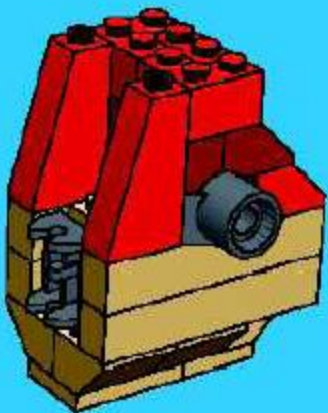

14

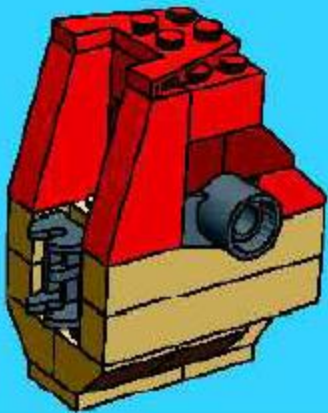



1x



1x

1

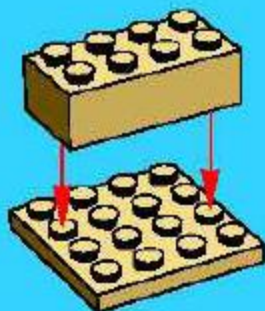

4x

2



2x

3



1x



1x

4

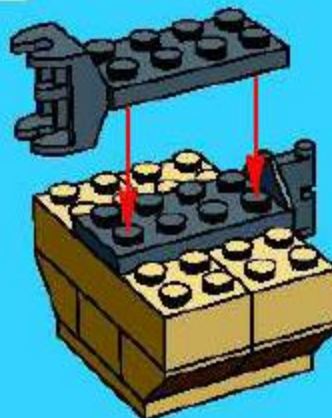



1x

5



1x



1x

6



2x

4x

4x

7

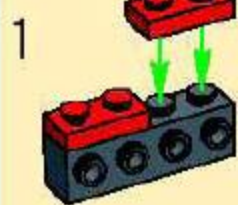
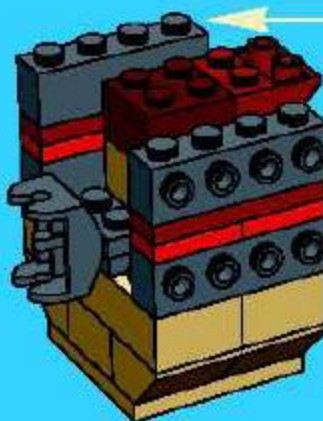

1

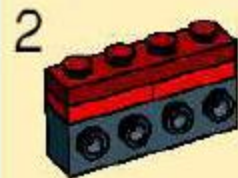

2

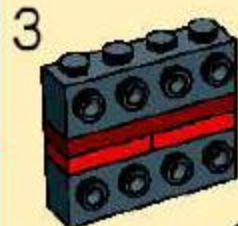

3

2x



1x

1x

8

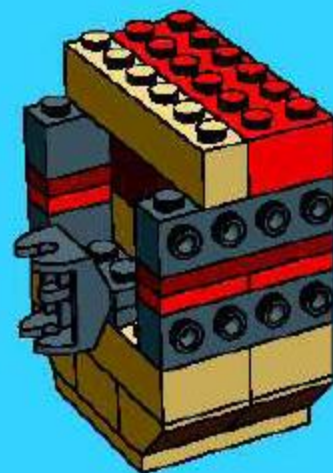

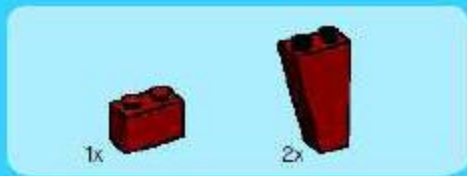

9



1

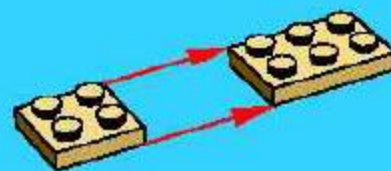

15

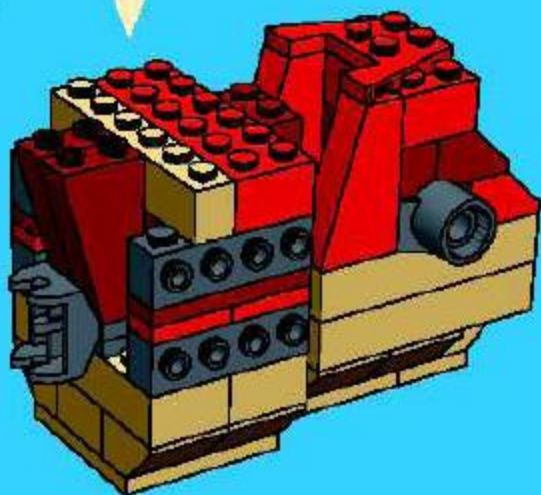

2





2x

3



2x



1x

4



4x



2x



2x

5



2x



1x

6

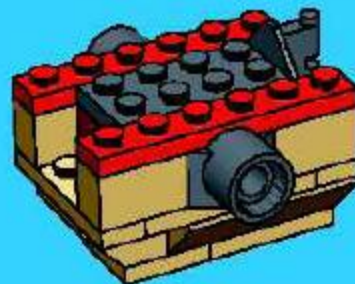

1x



1x



1x

7



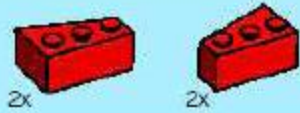

2x

2x

8



1x

2x

1x

10



2x

2x

9

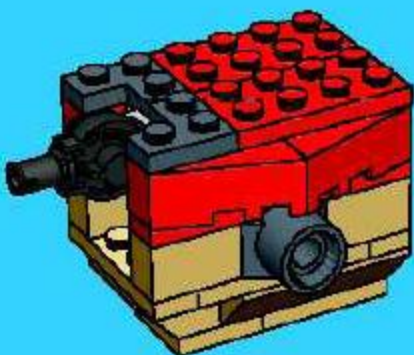

2x

11

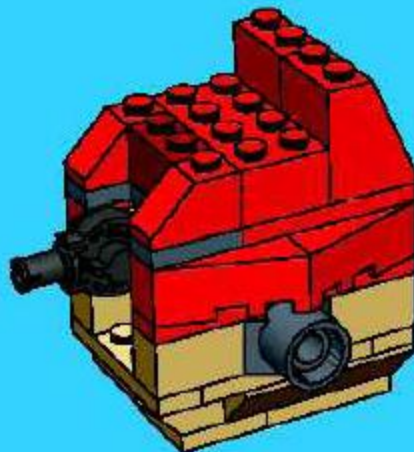

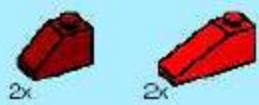

12

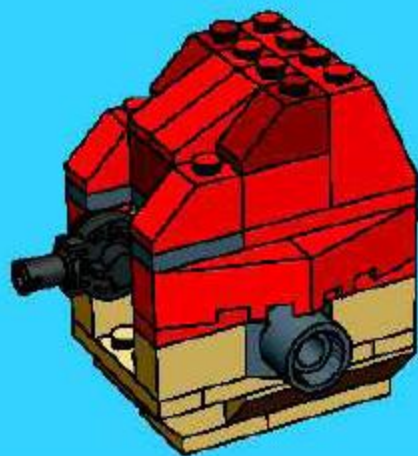

13



16

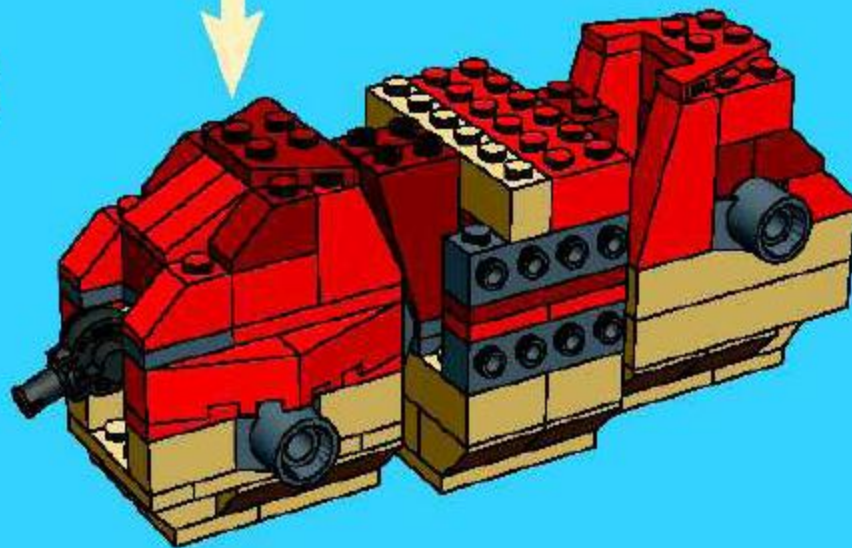

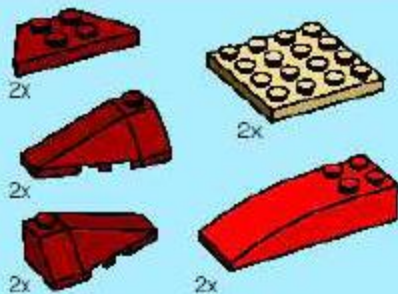

17

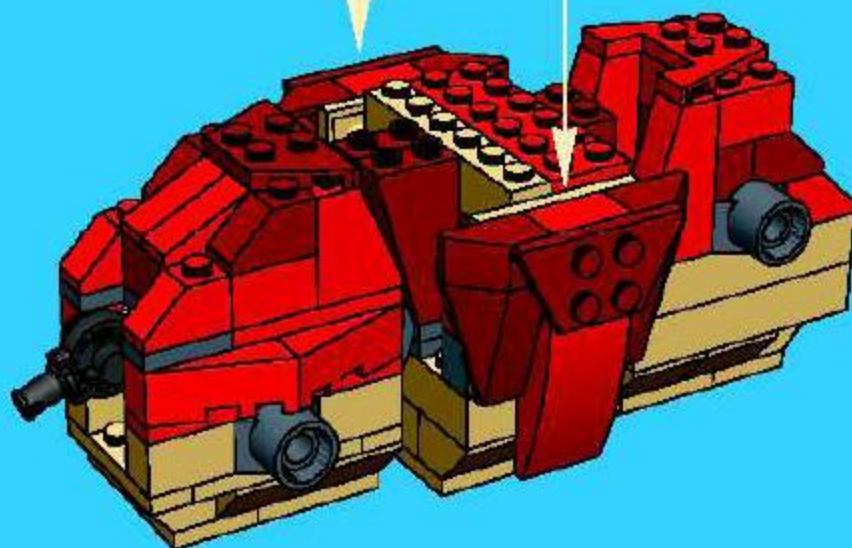
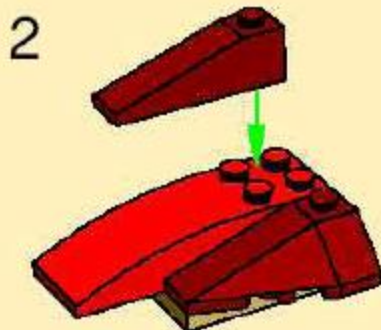
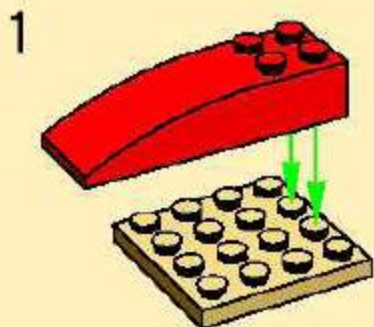

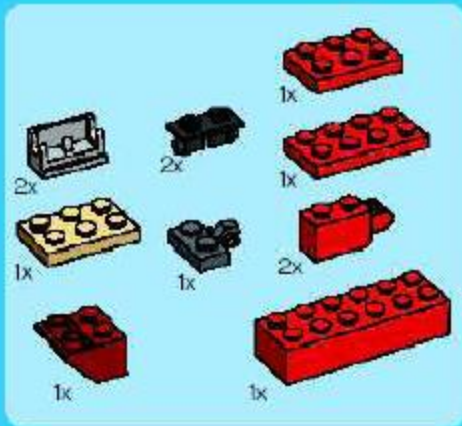

18

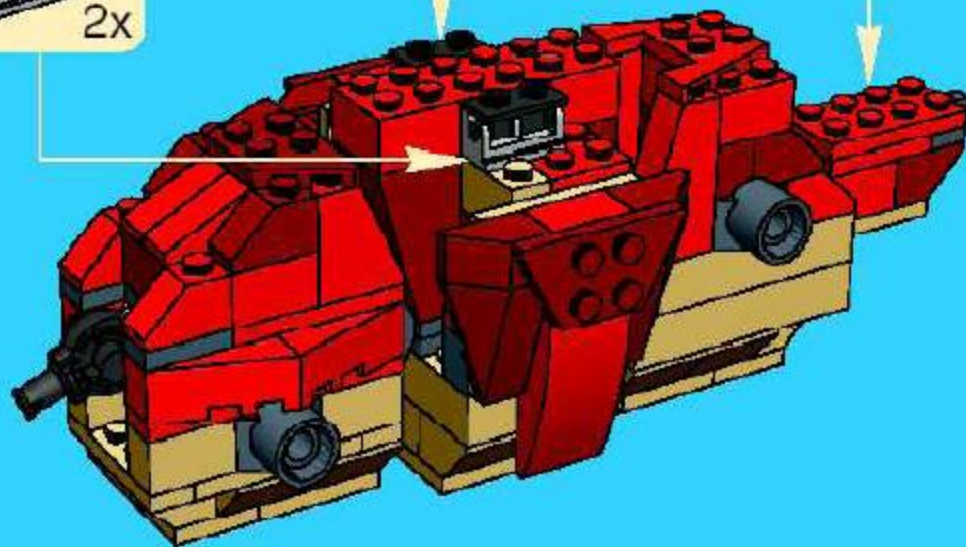
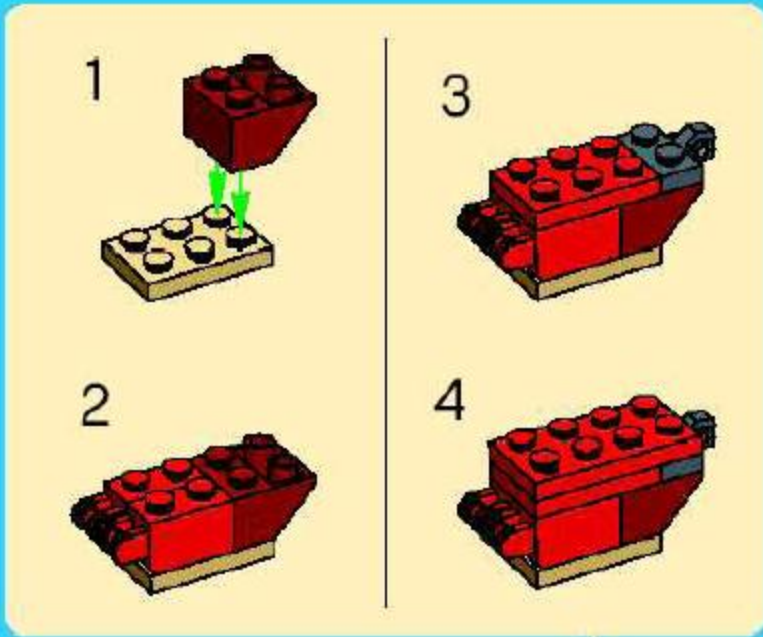

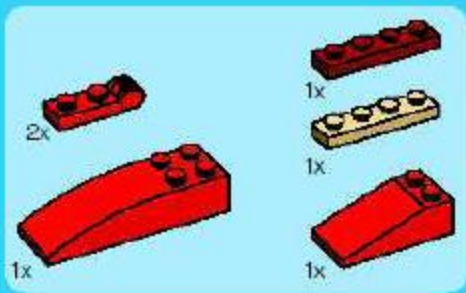

19

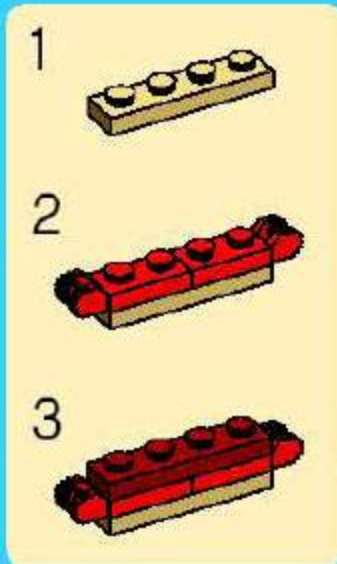



20





4x



2x



2x

21

1

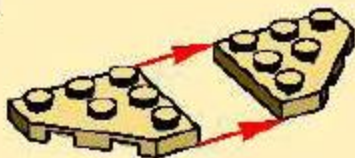

2



3



2x

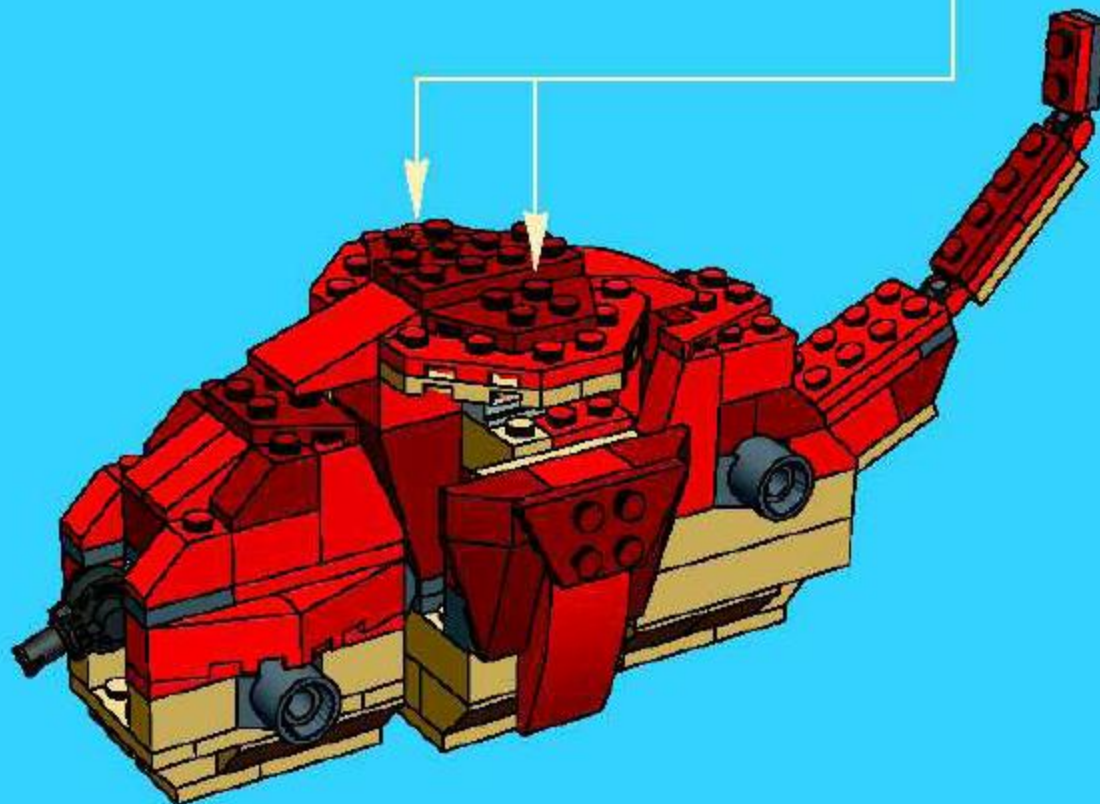



1

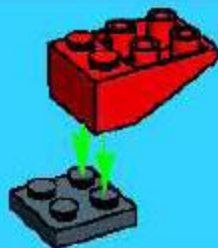

2



3

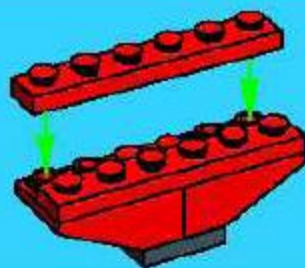

1x

4



1x



1x

5

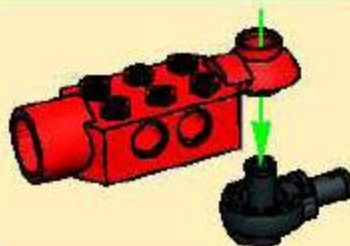

2x



1x

6



1x

7

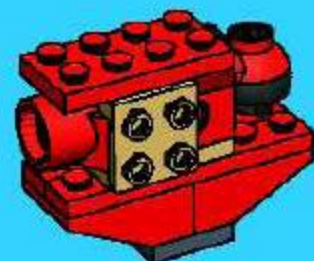



8

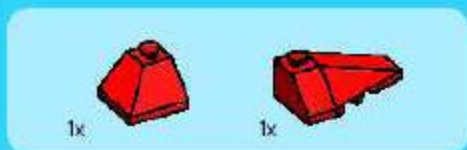
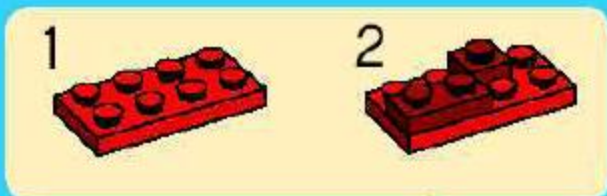

9

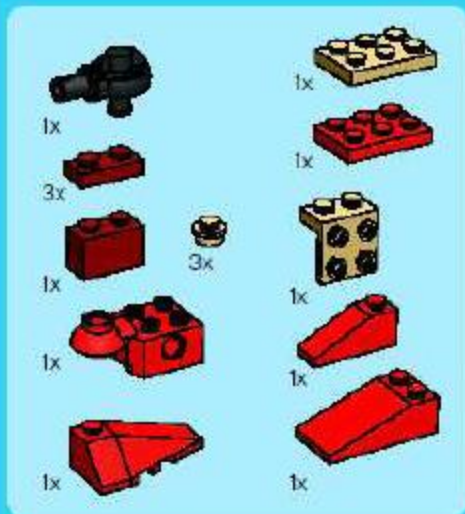

10

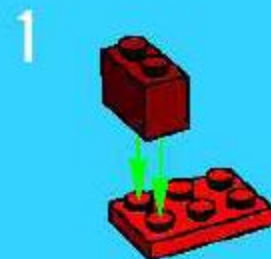

3



4



5



6

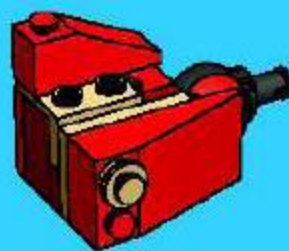

7



8

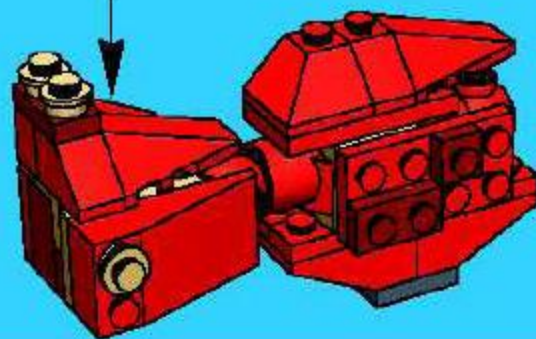

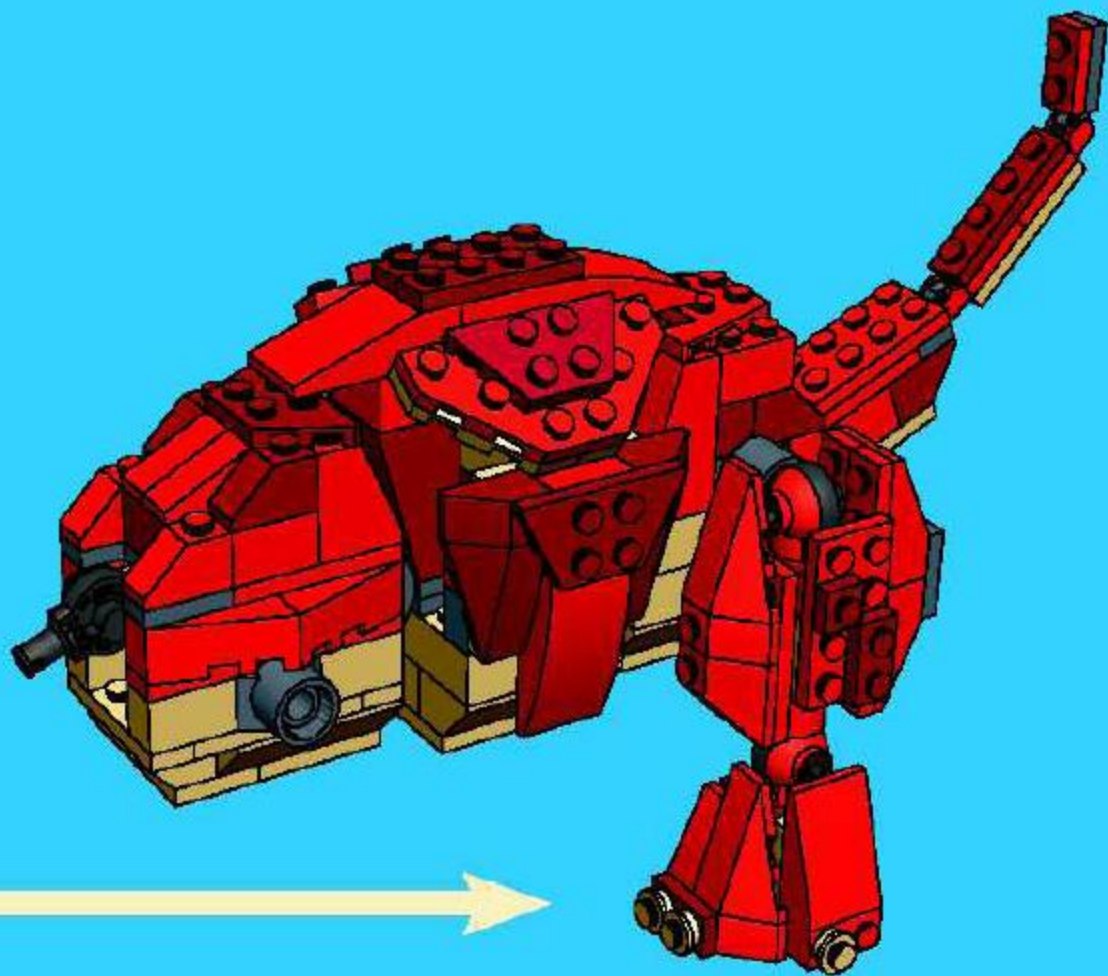

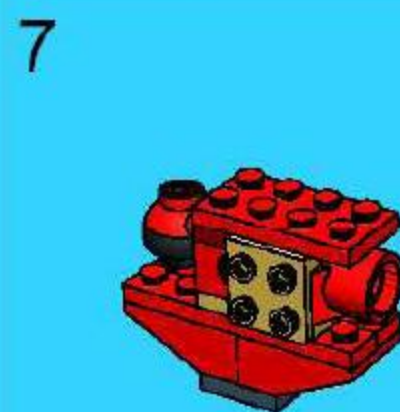
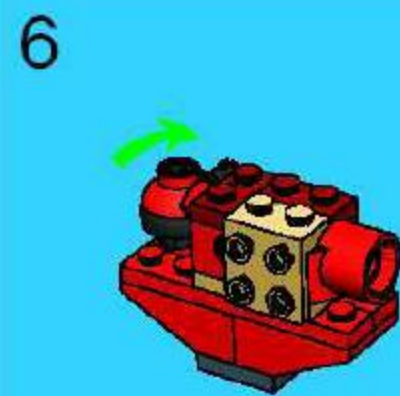
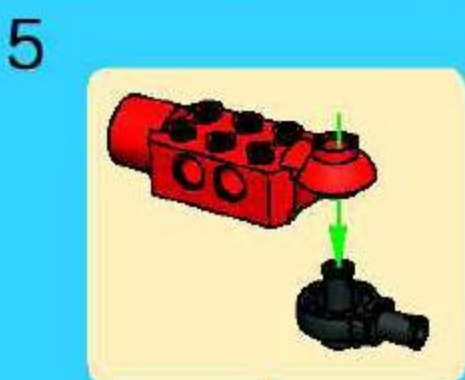
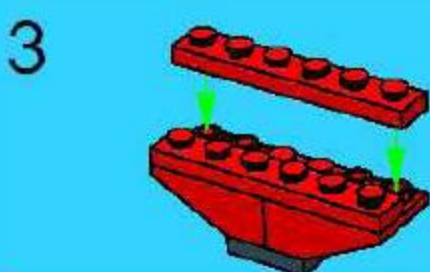
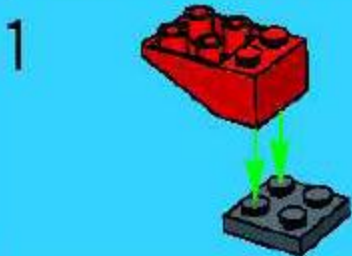



8



9

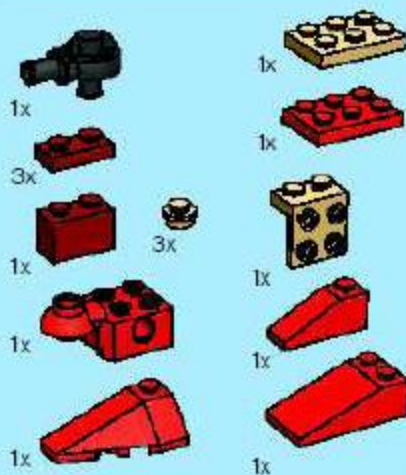

10



3



4



5



6



7



8

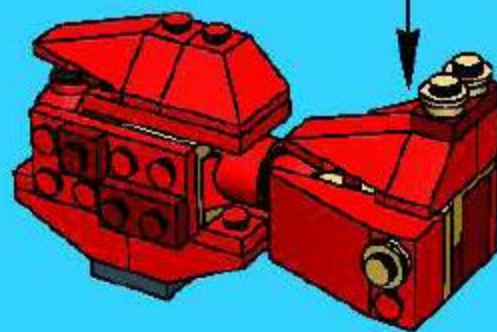





24



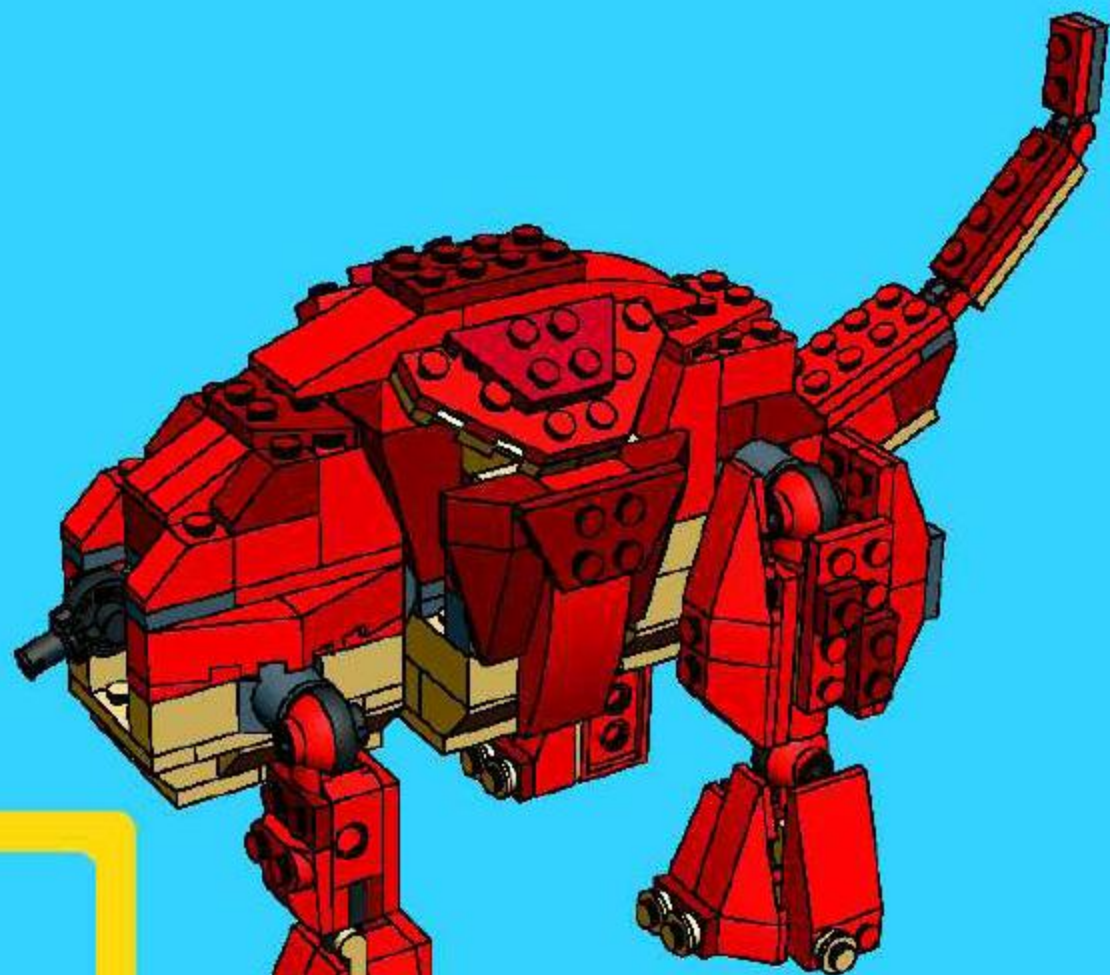

7

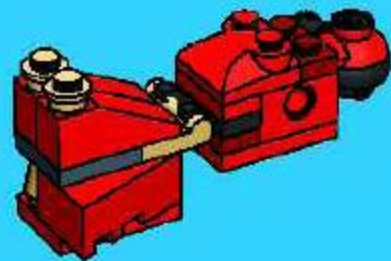

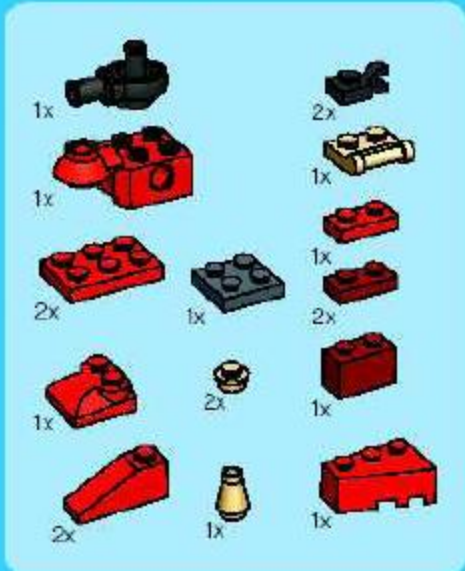

25

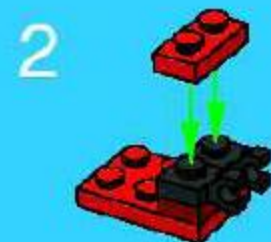

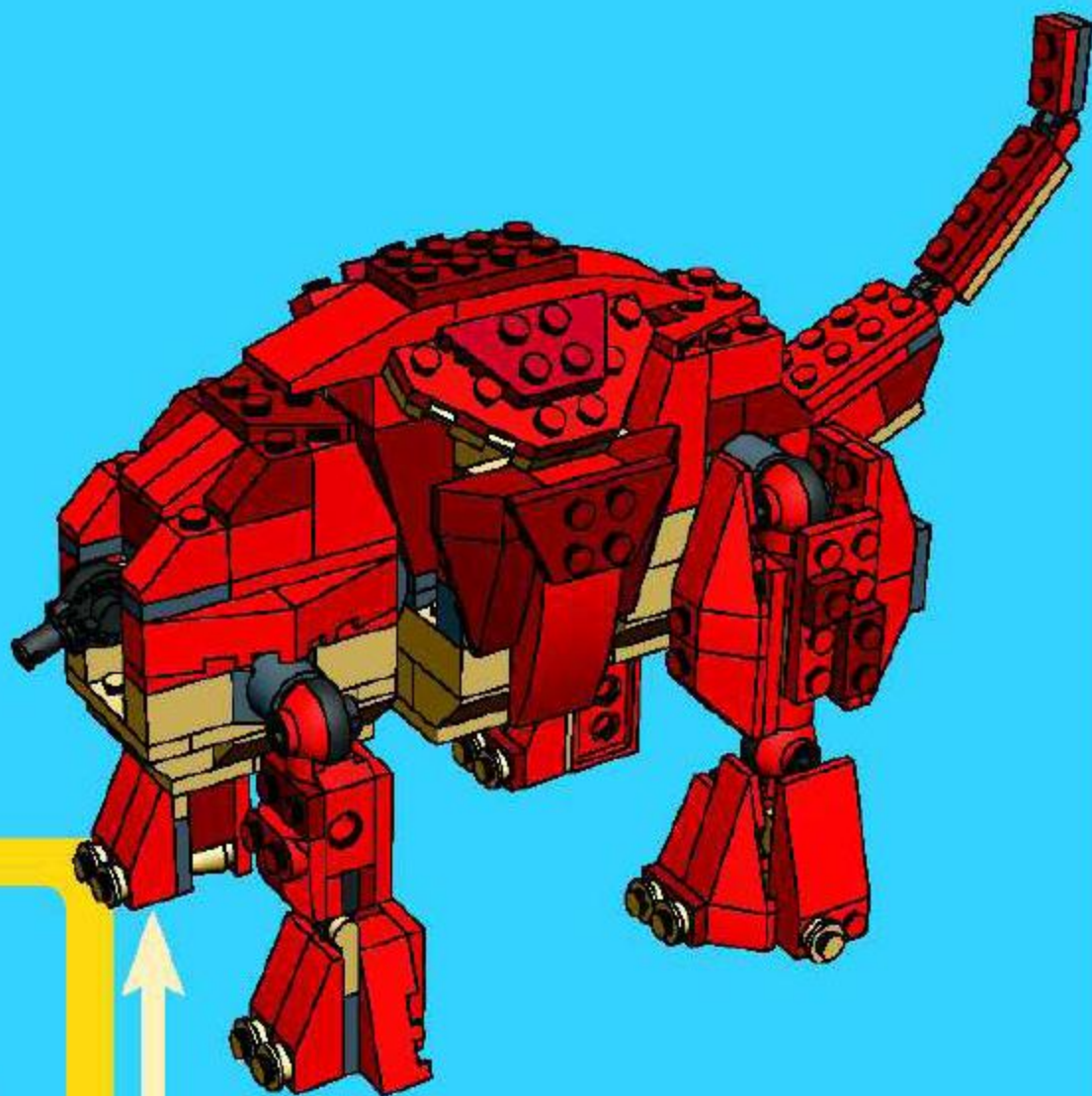

7





1

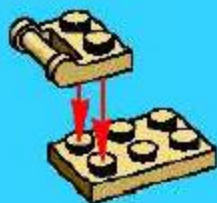

2



3

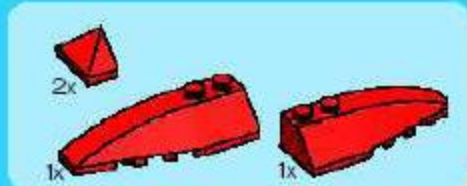
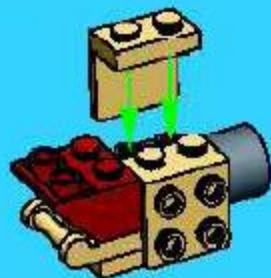

4

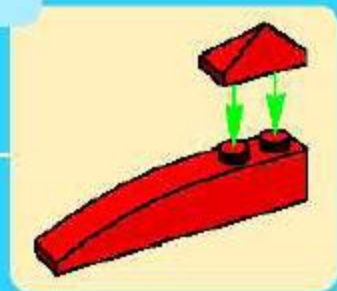

5





6



7



8

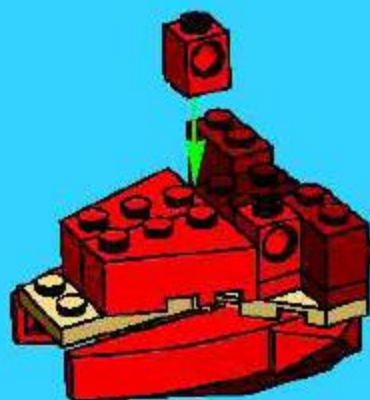

9

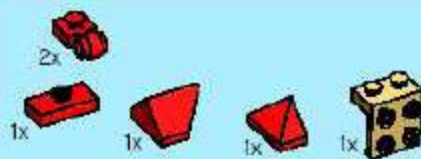
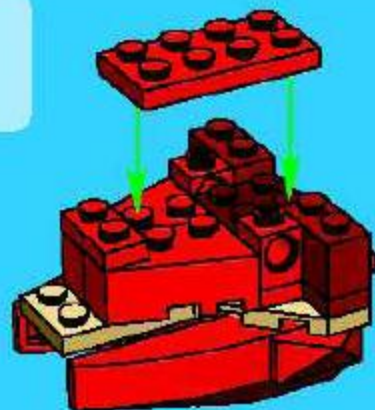

10

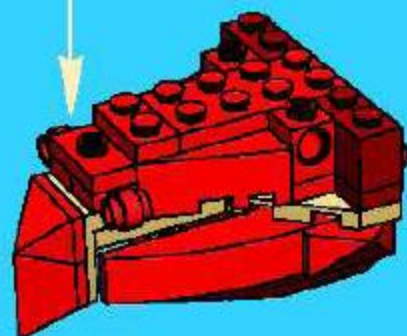
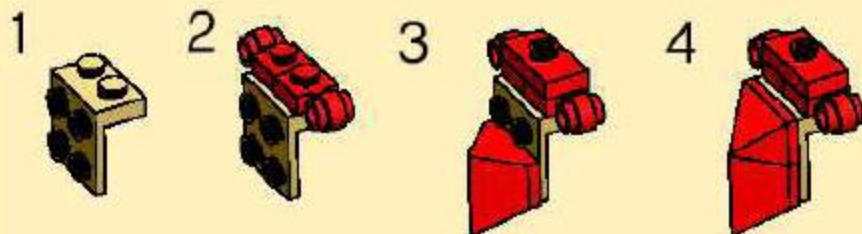



11



12

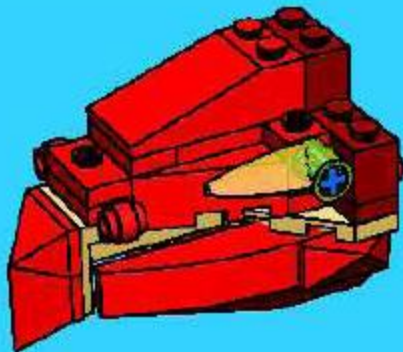

13

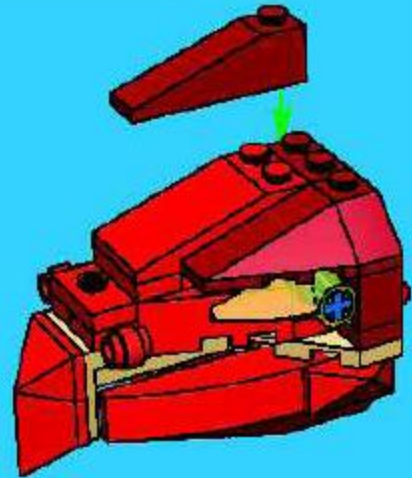

14





1x



2x



1x

15



1

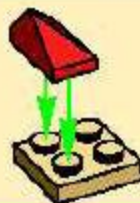

2



26

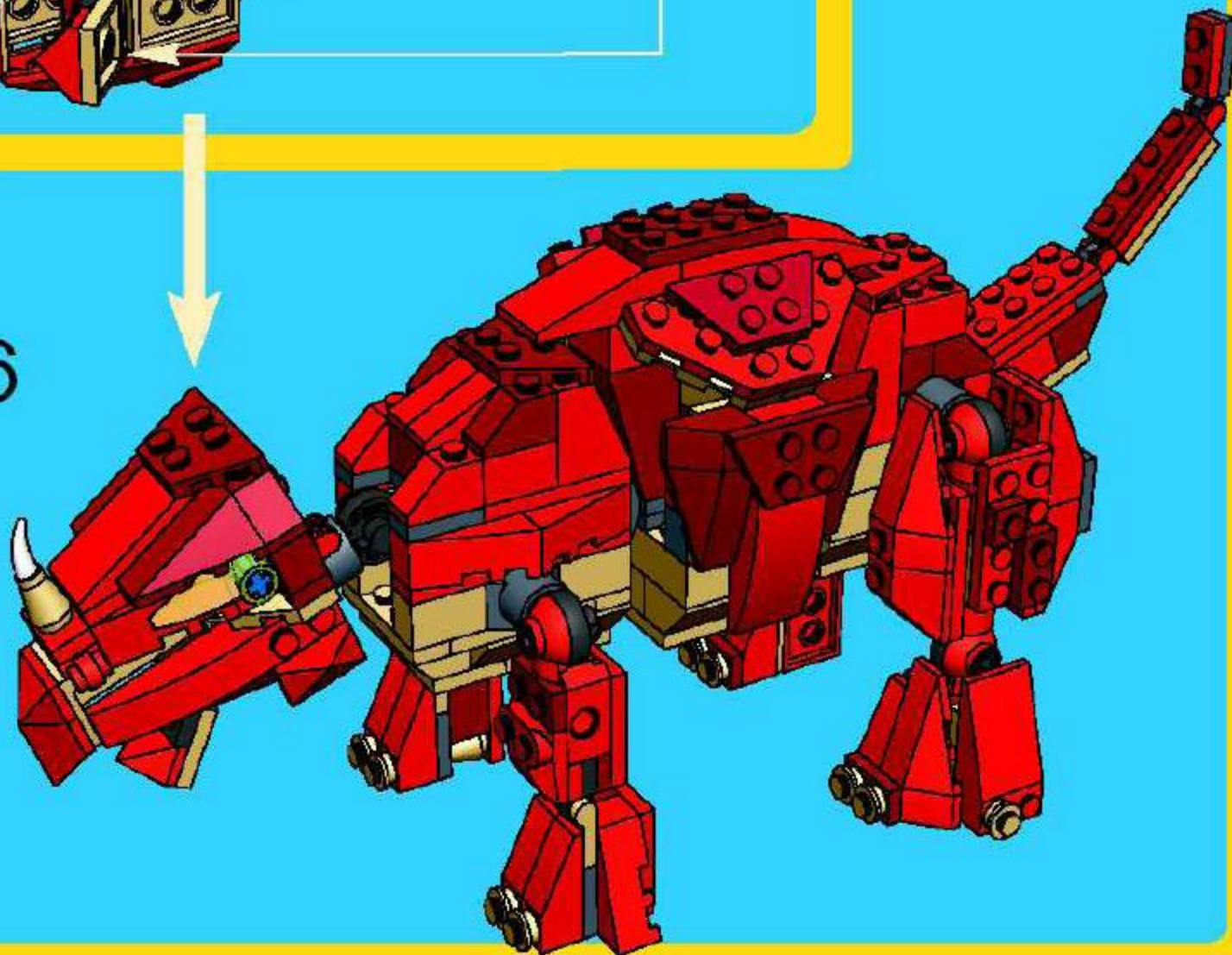

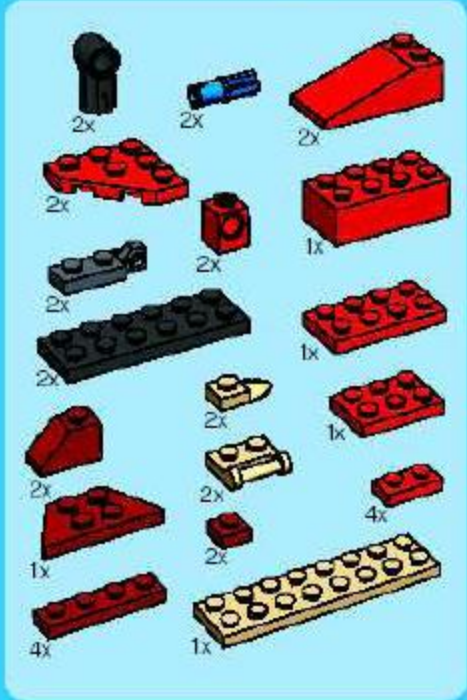

27

1



2

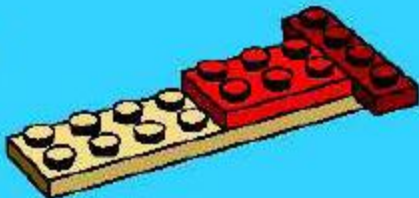

3



4

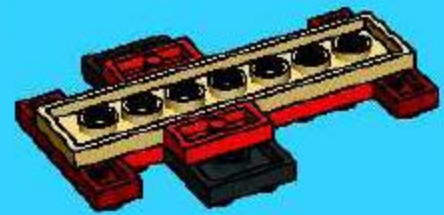

5



6



7

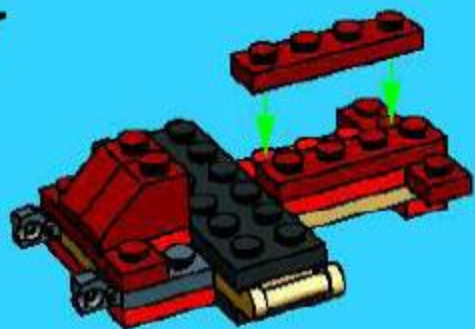

1

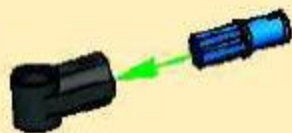

2

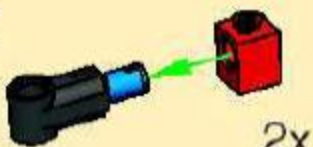

8

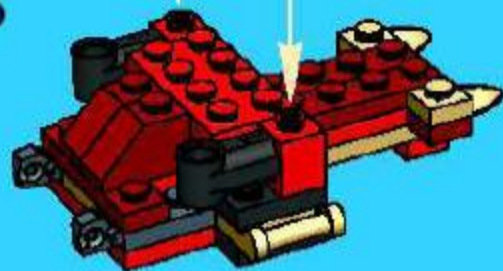

9



10



11



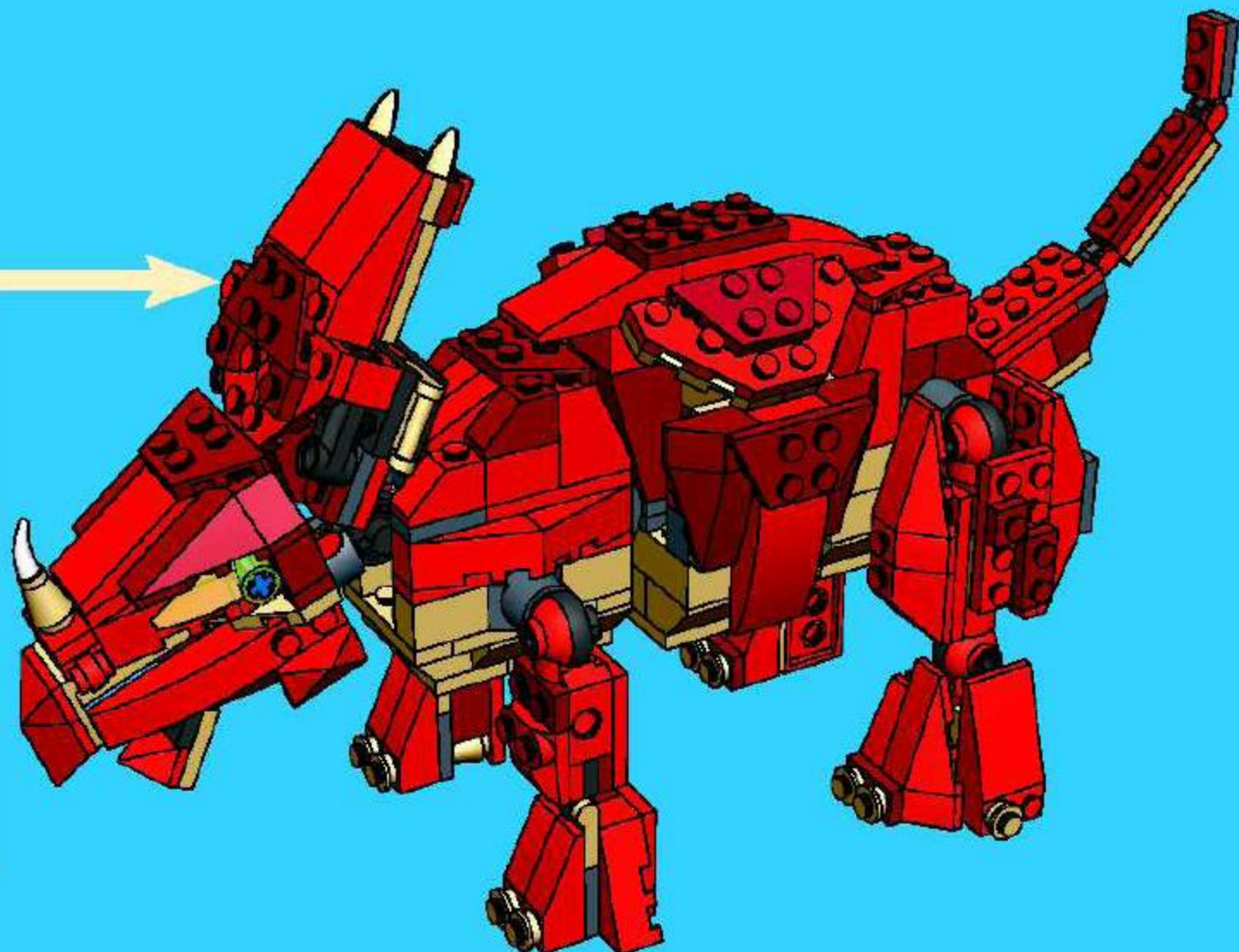

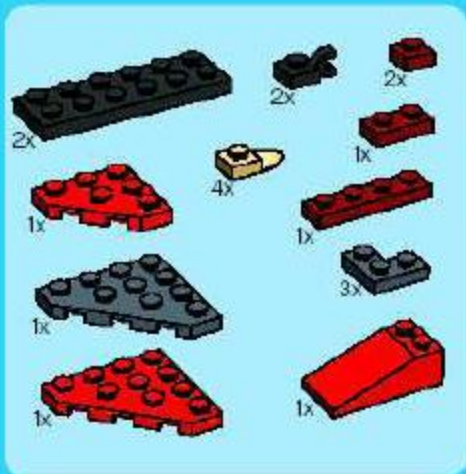

28

1



2



3



4



5

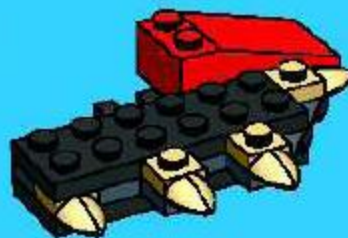

6

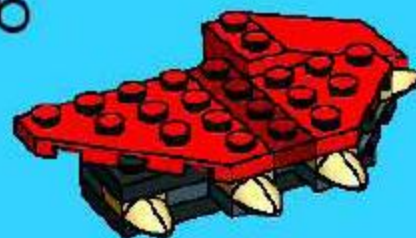

7



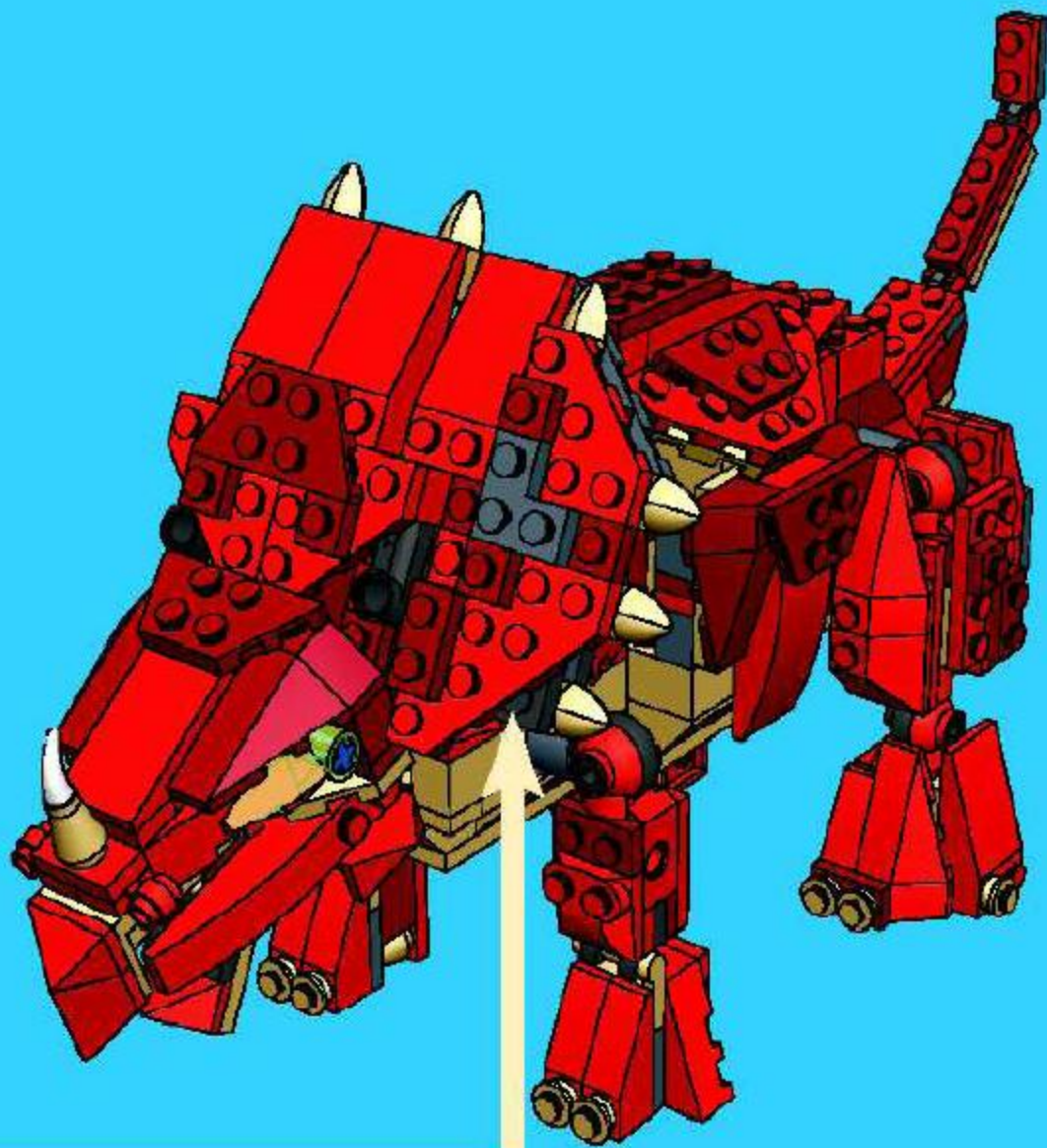

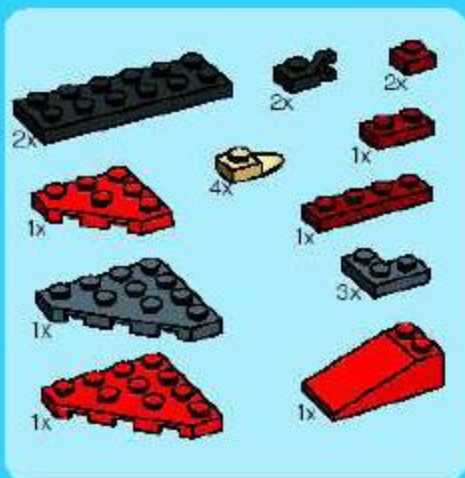

29

1



2



3

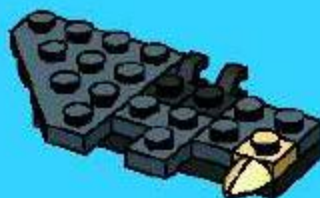

4



5



6



7



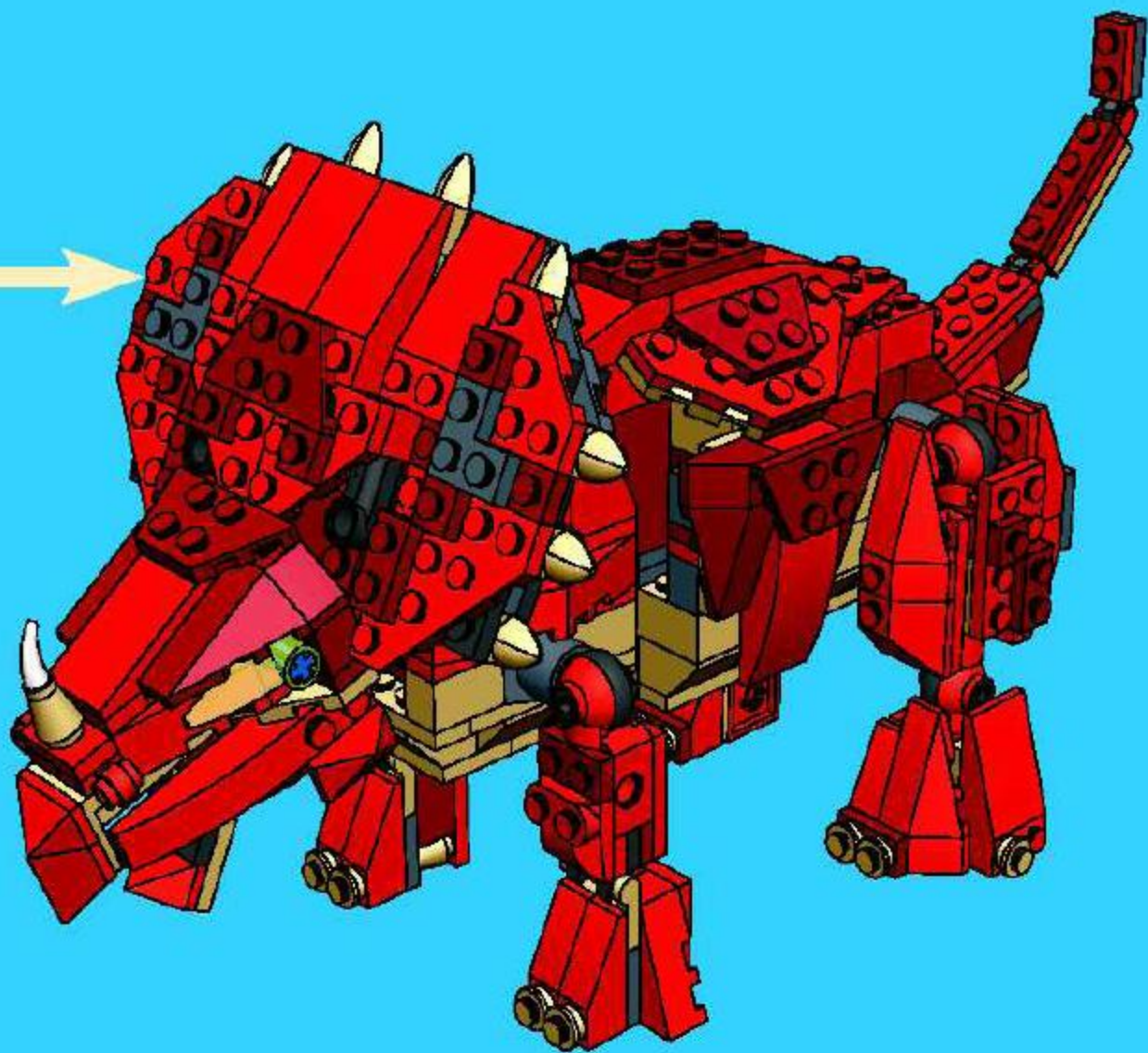



2x



2x

30



2x

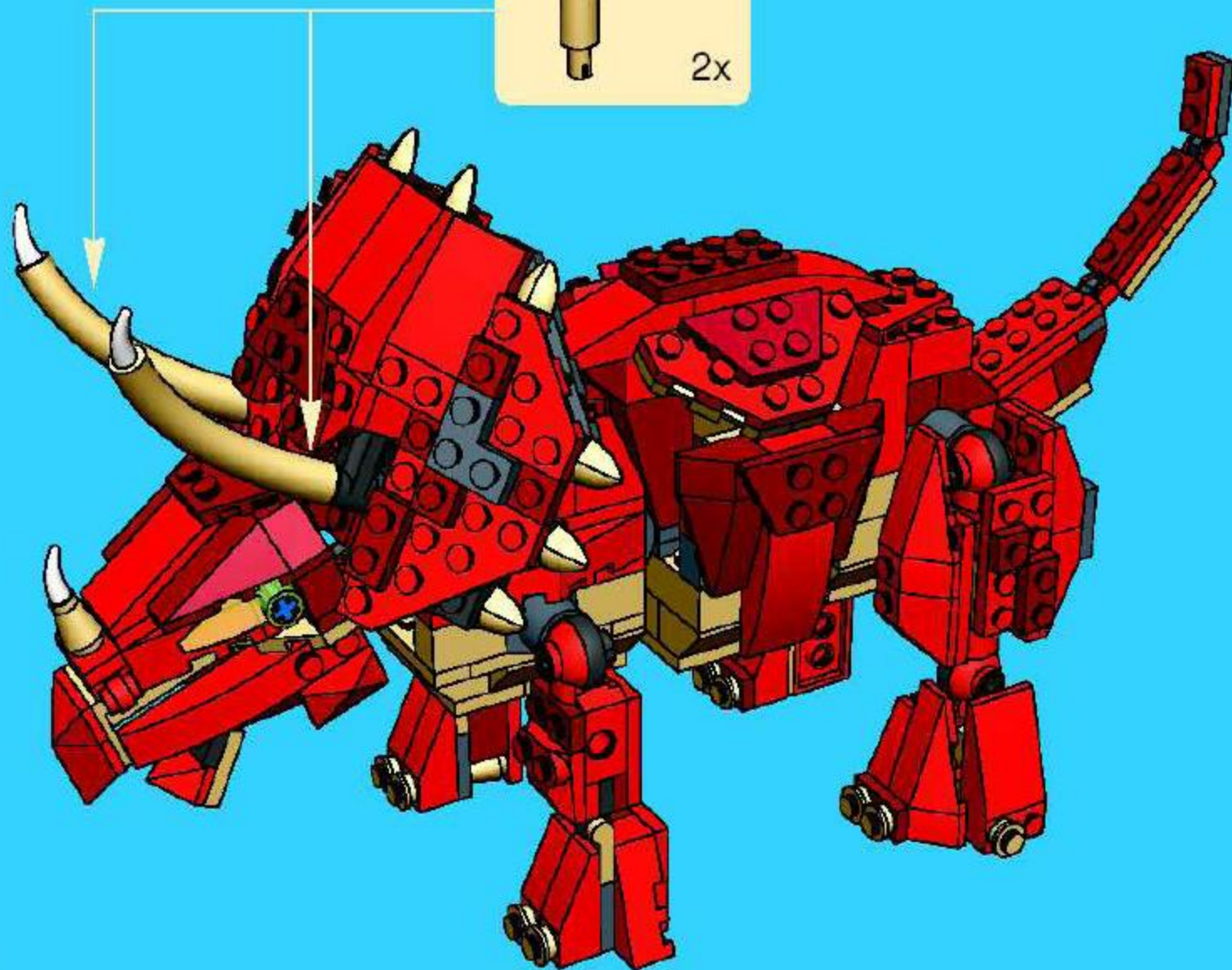

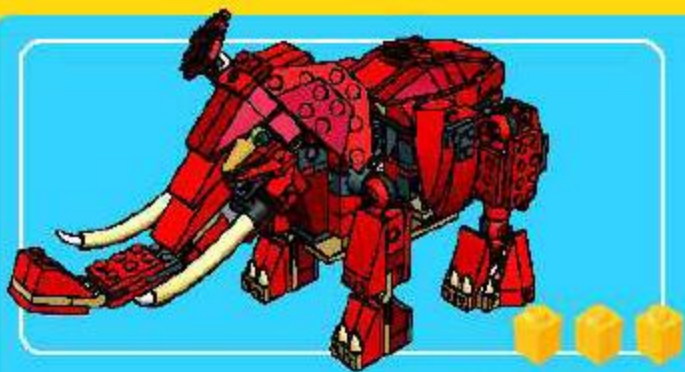

1

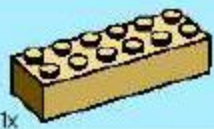

2



3



4



5

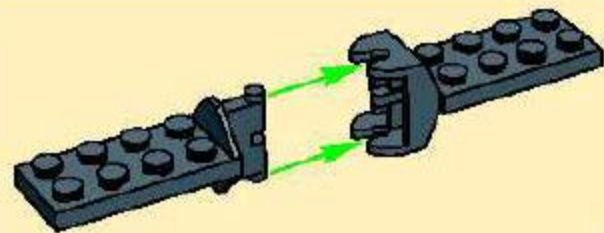



6

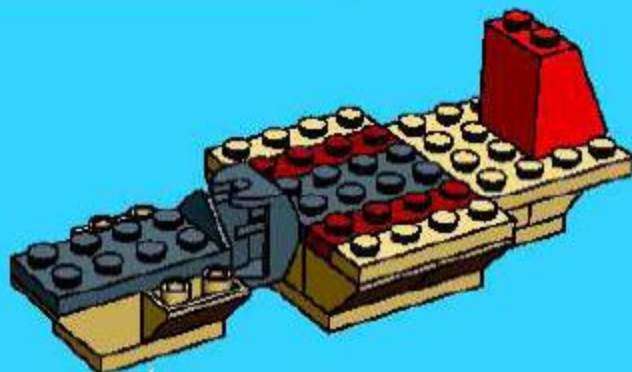

1



2



2x



2x



7



8

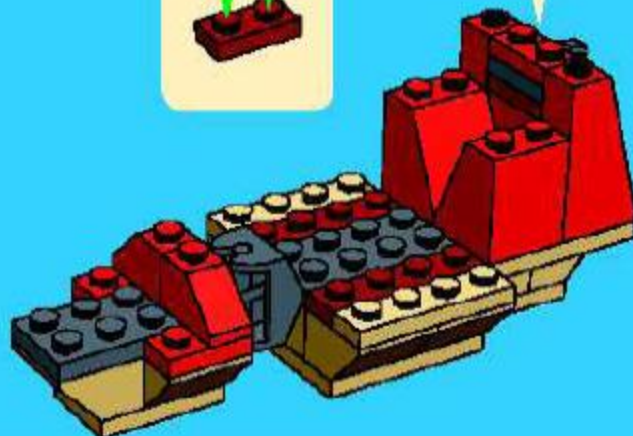

1x



2x



1x



1x



9

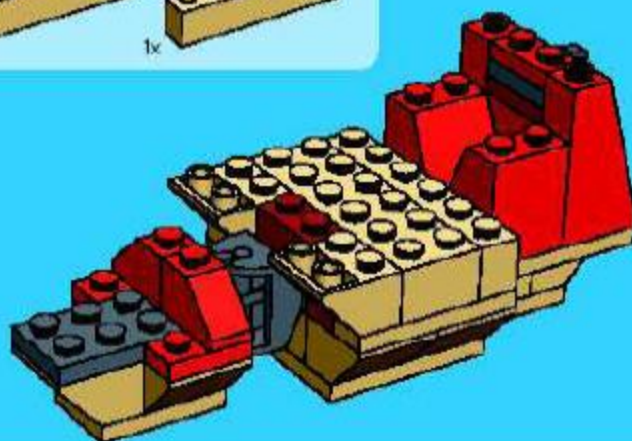

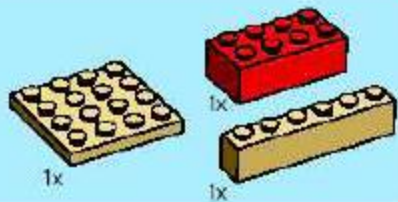

10

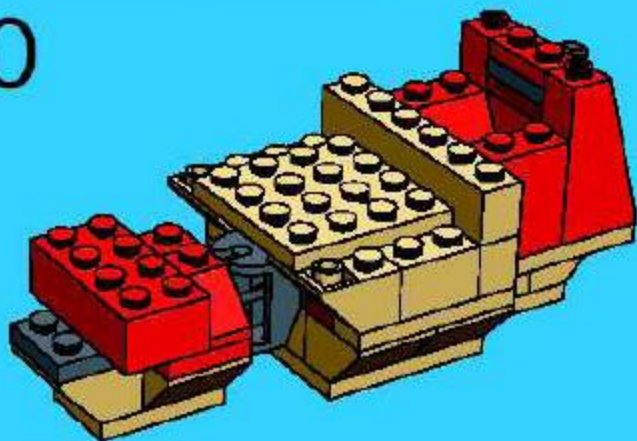

11

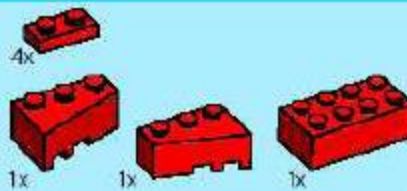
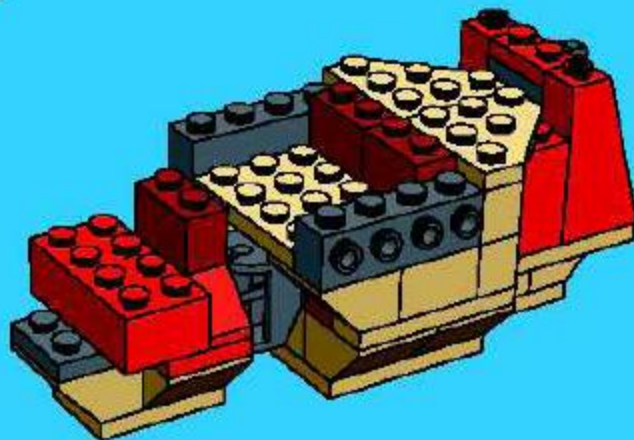

12

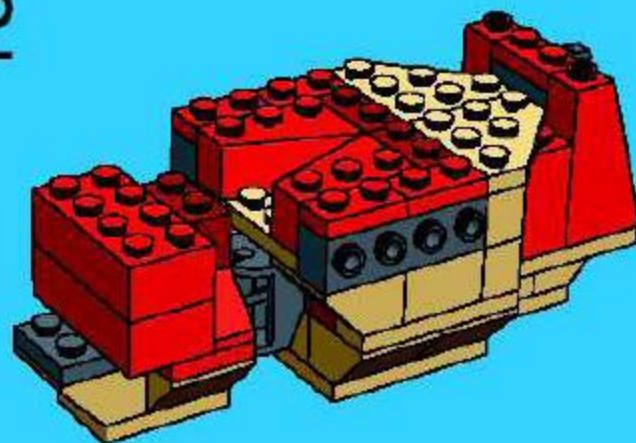

13

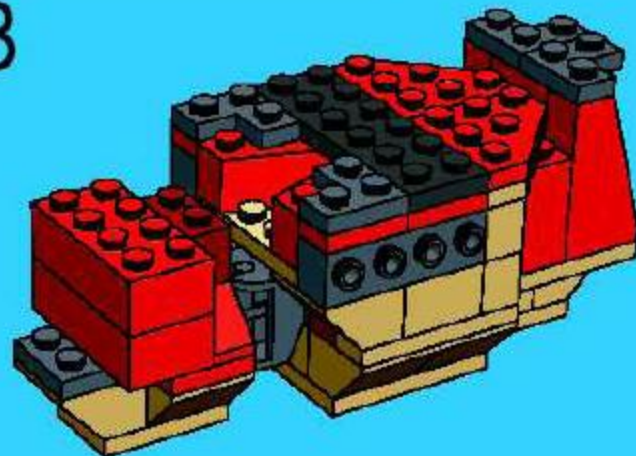



4x



1x



1x

14

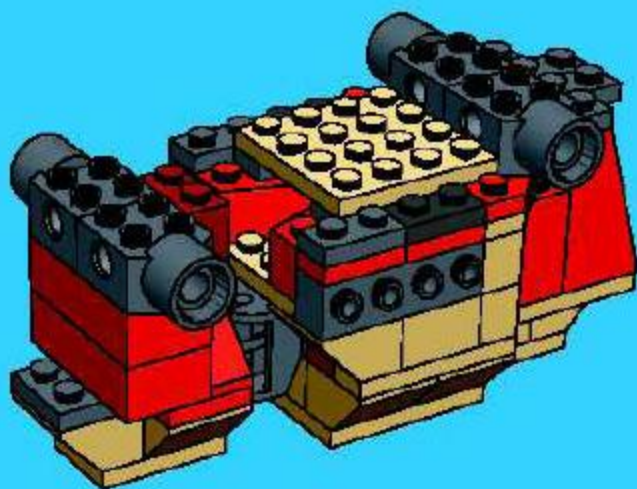

1x



2x



2x

15





16

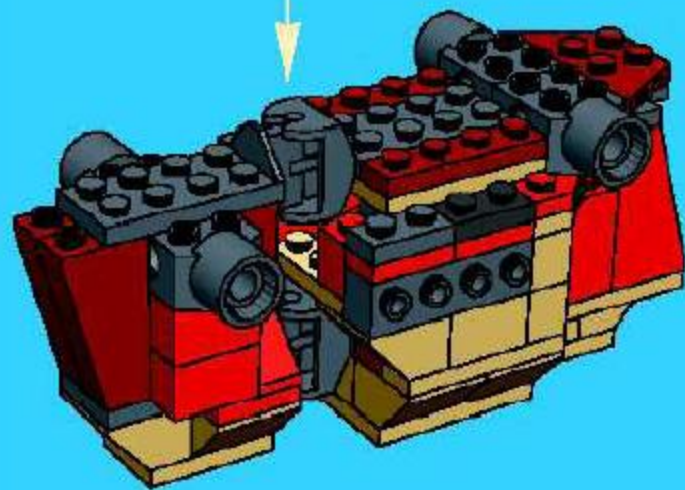
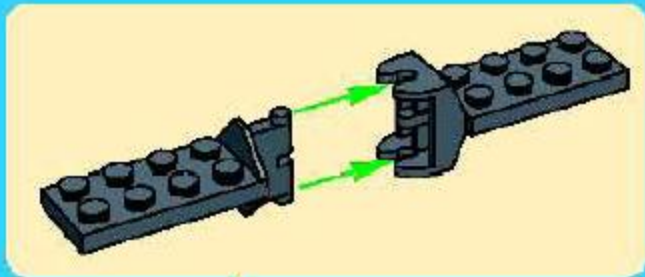

17

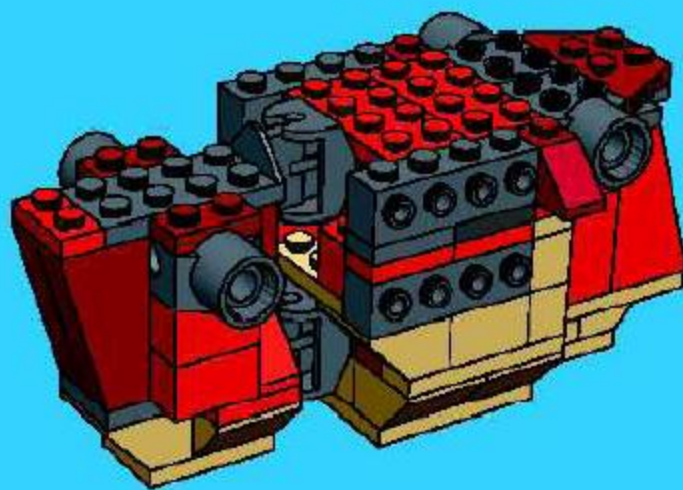

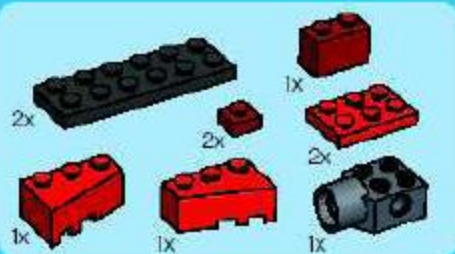

18



19



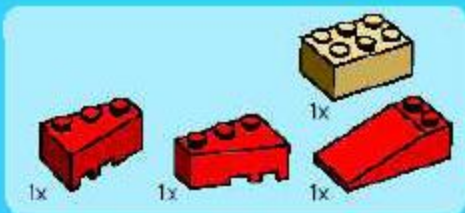

20



21

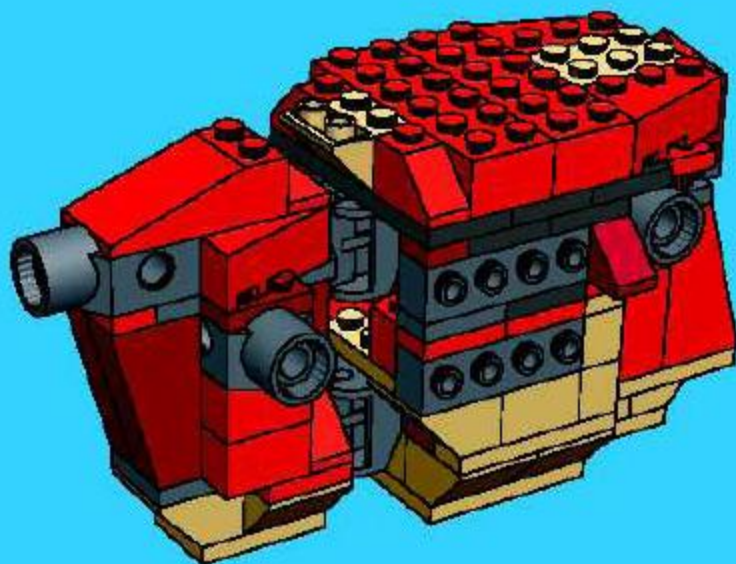

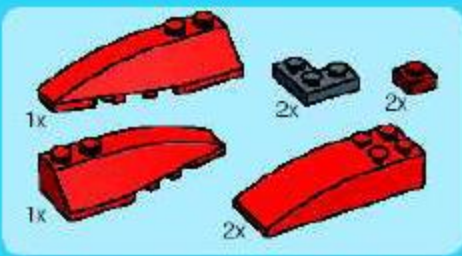

22

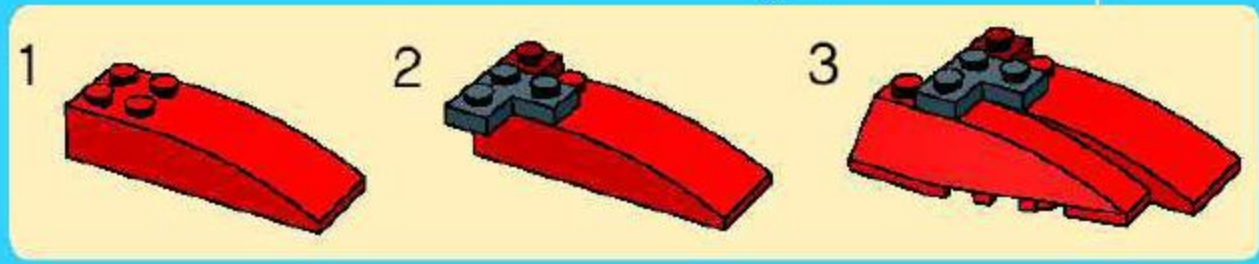
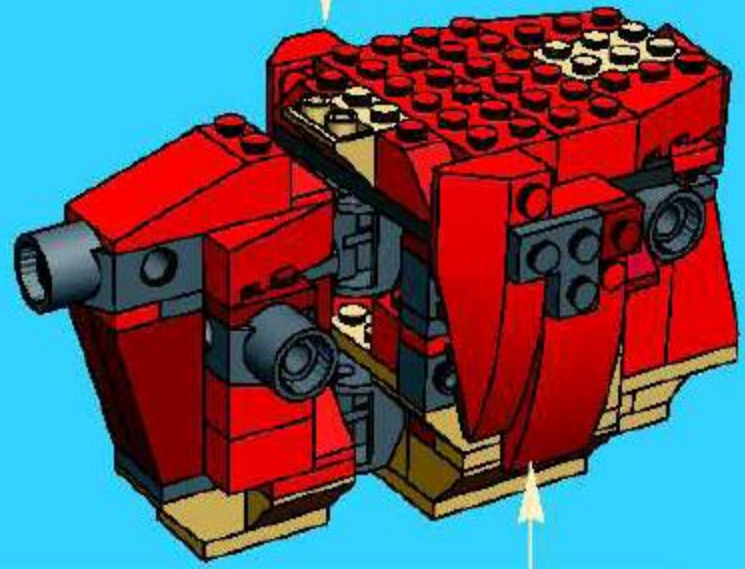
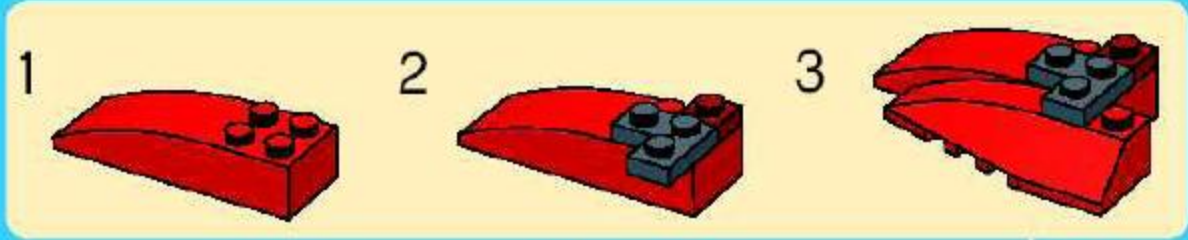

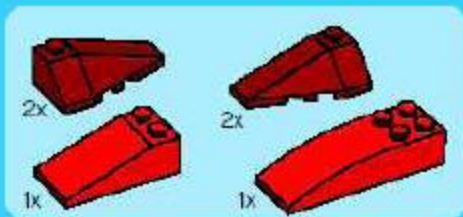

23

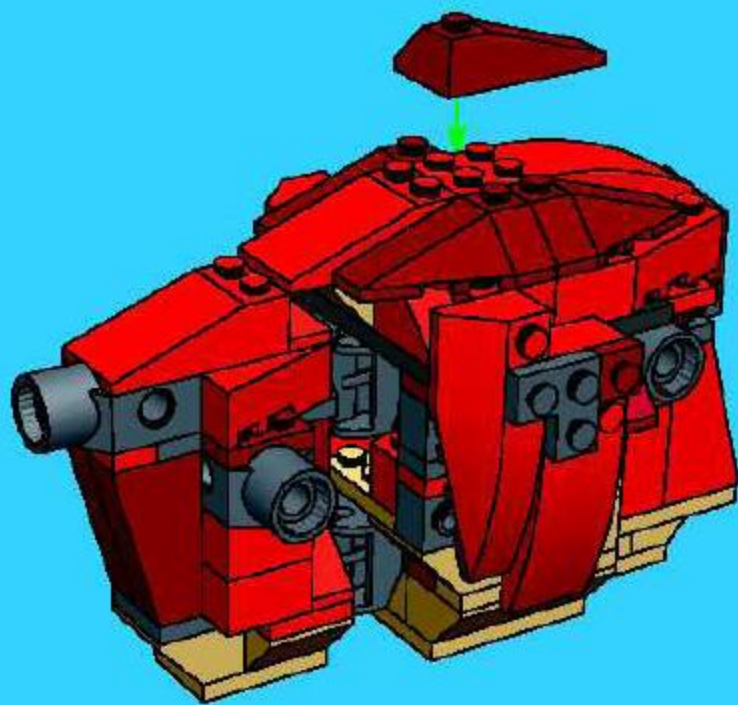



24

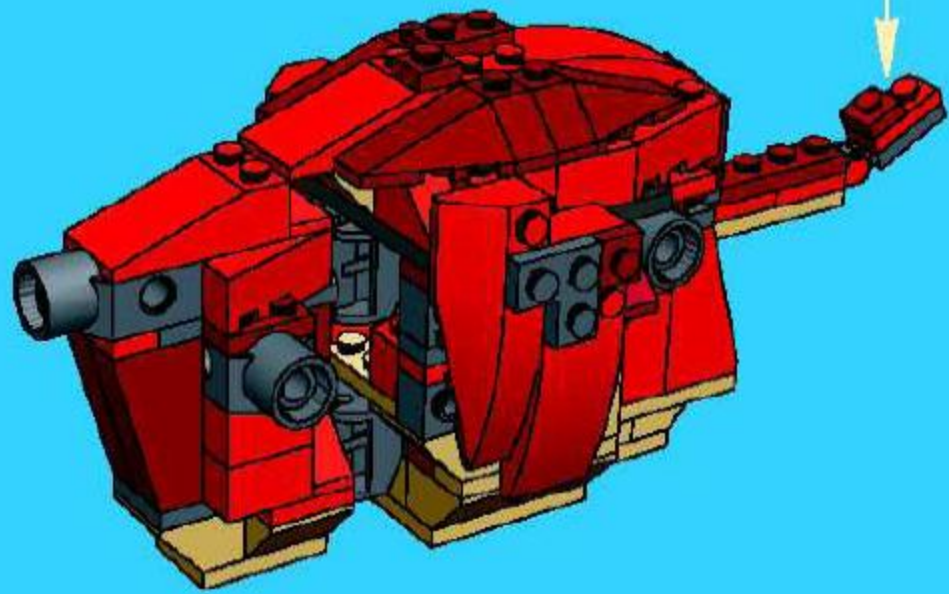
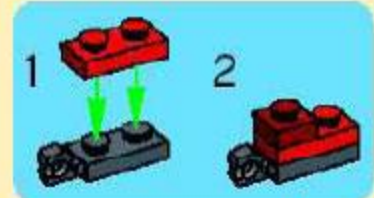
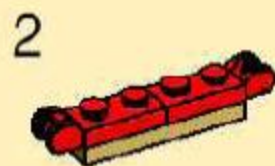

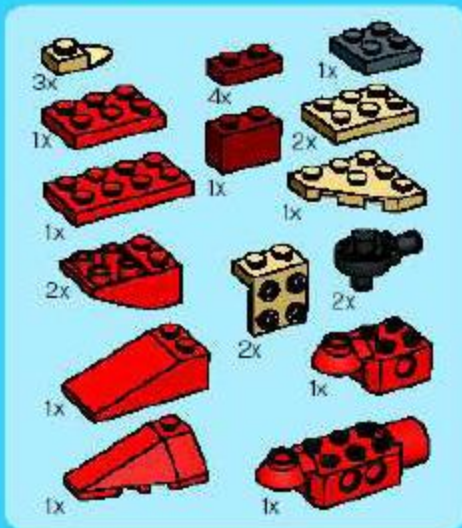

25

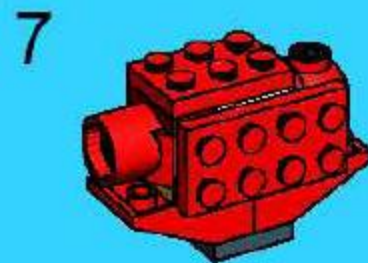
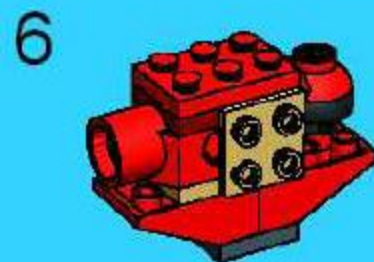

1



2



3



4

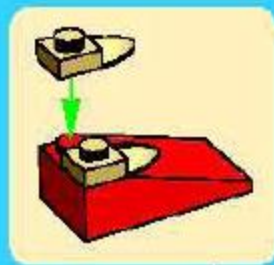

5



6



7

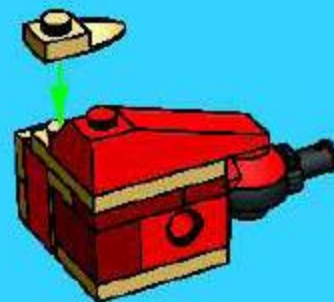

8

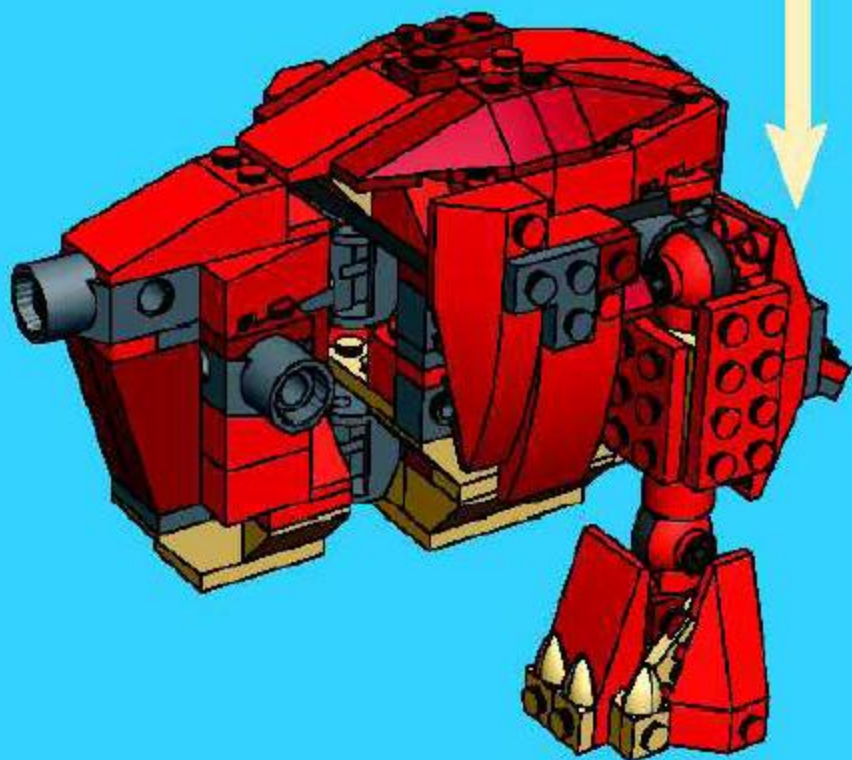
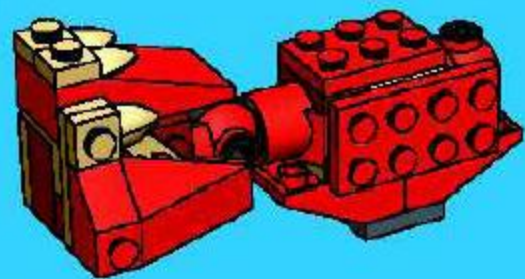



26

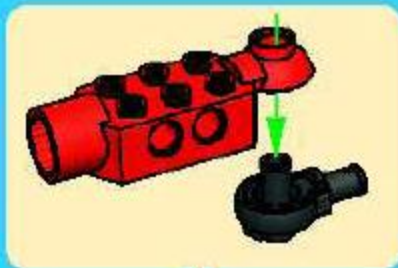
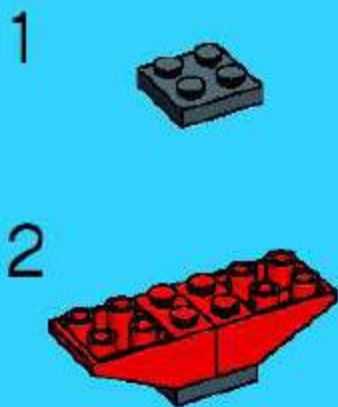

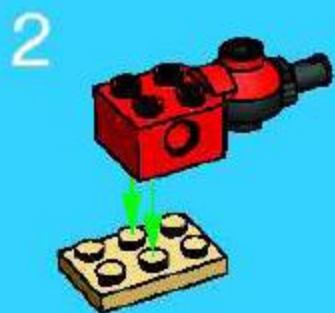

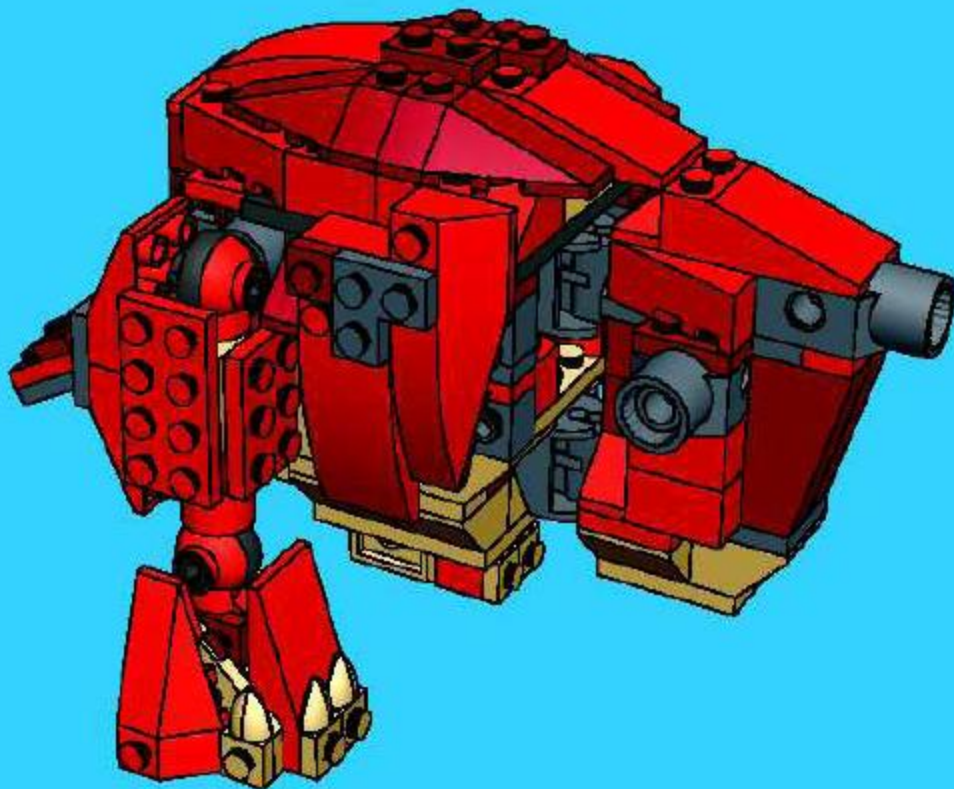

8

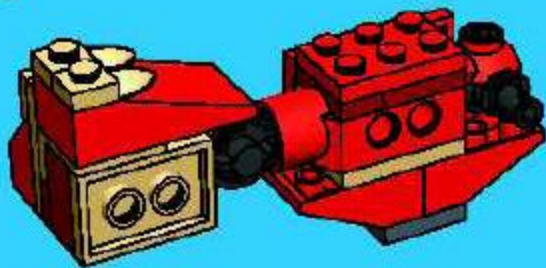

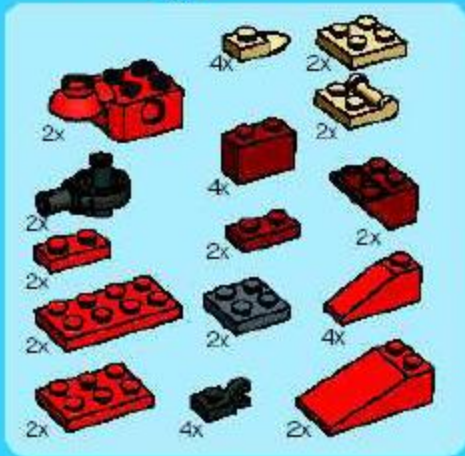
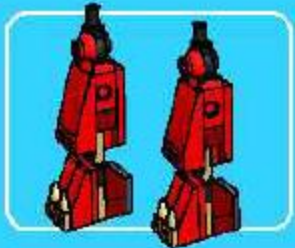

28

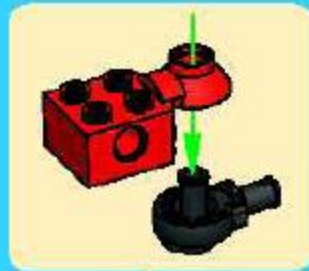
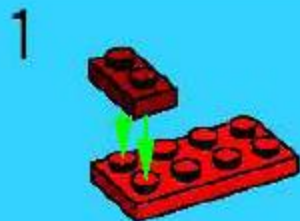

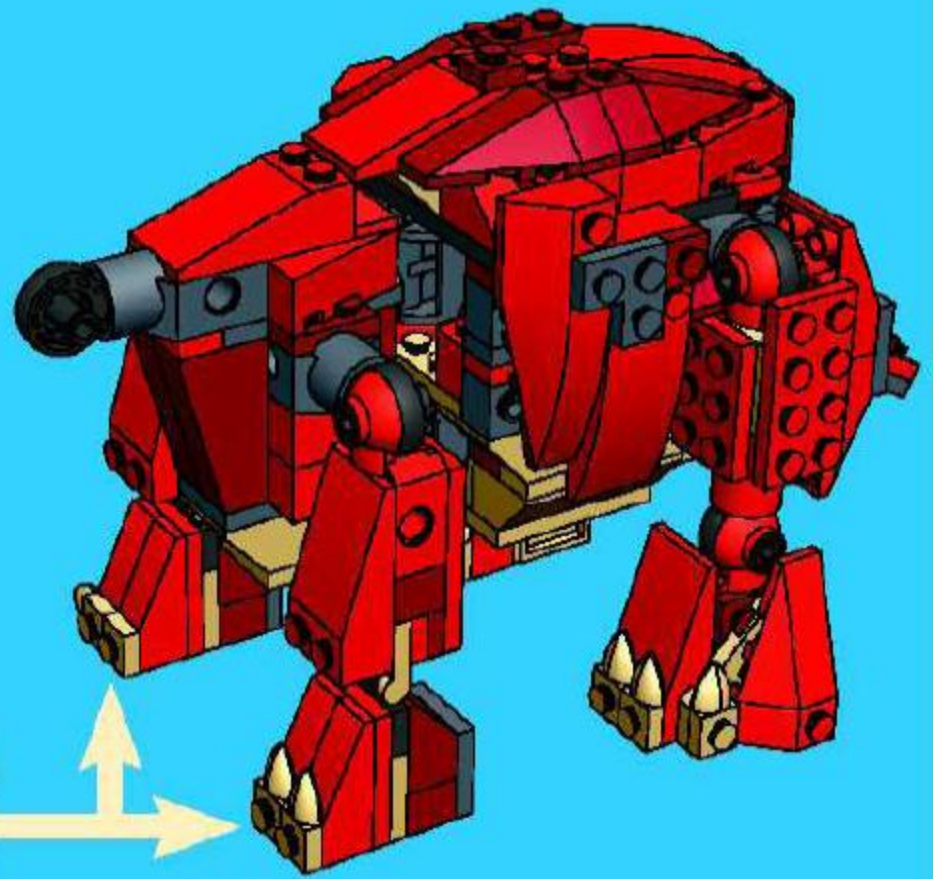

7

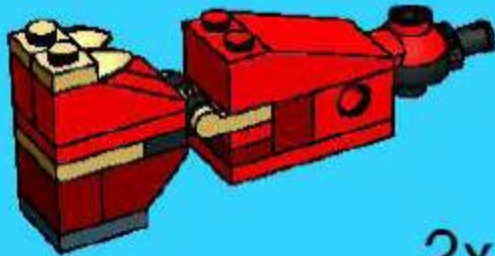

2x



1x



2x

1

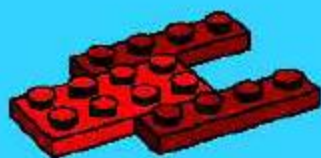

2x



1x

2



1x



1x

3





2x



2x

4

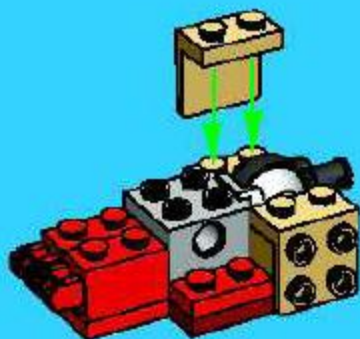

2x



1x

6



2x



2x



1x

5



2x

7

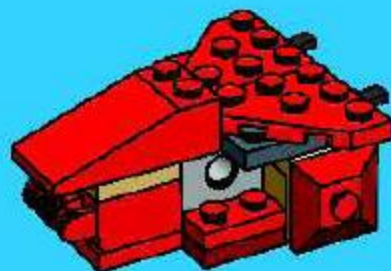



8

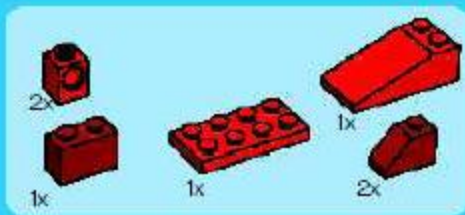
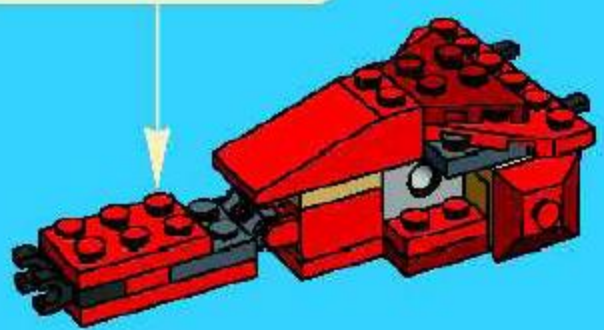
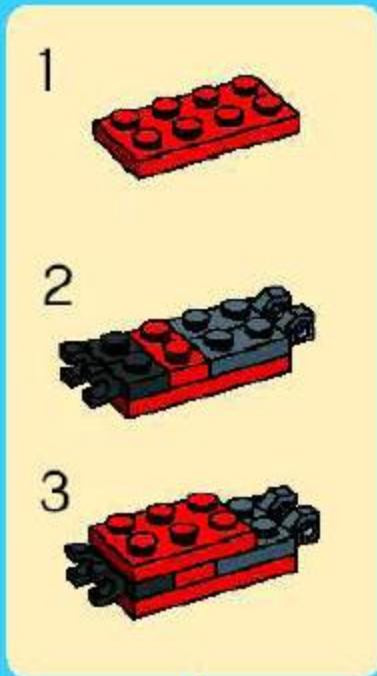

9

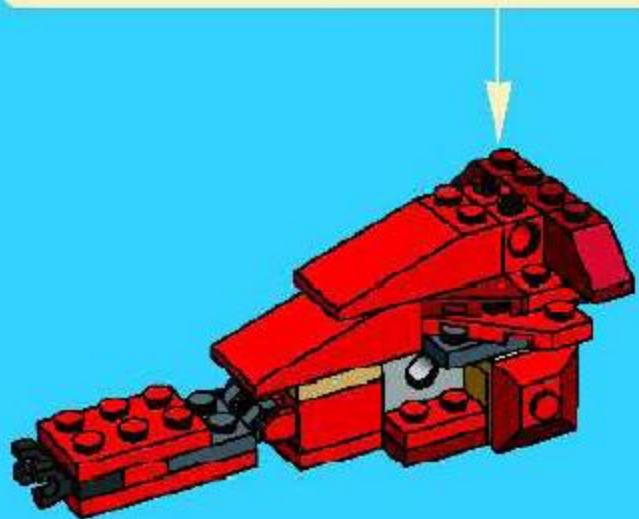
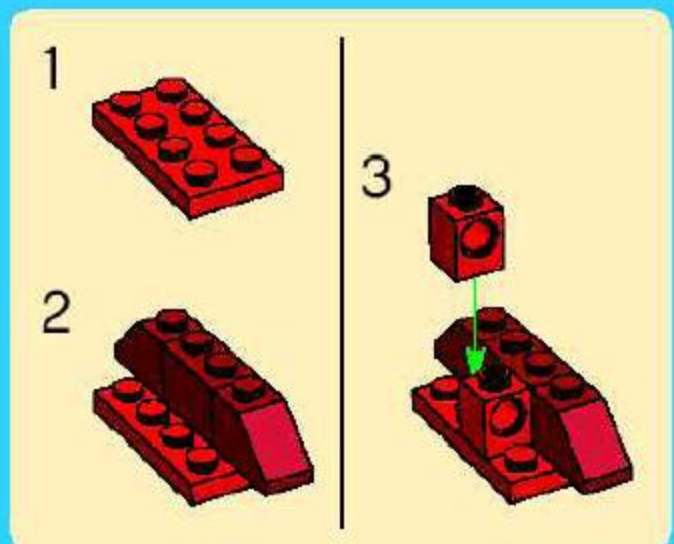



2x



2x

10

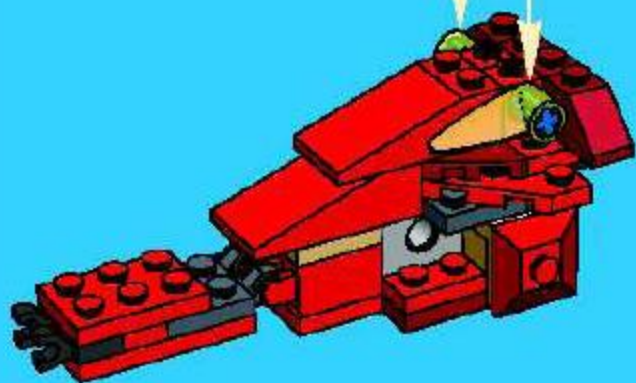
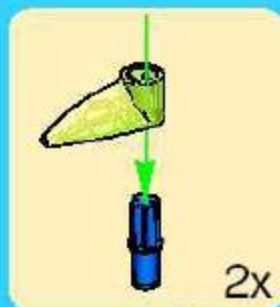

1x



1x



1x



1x



1x



2x

11

1



2



3

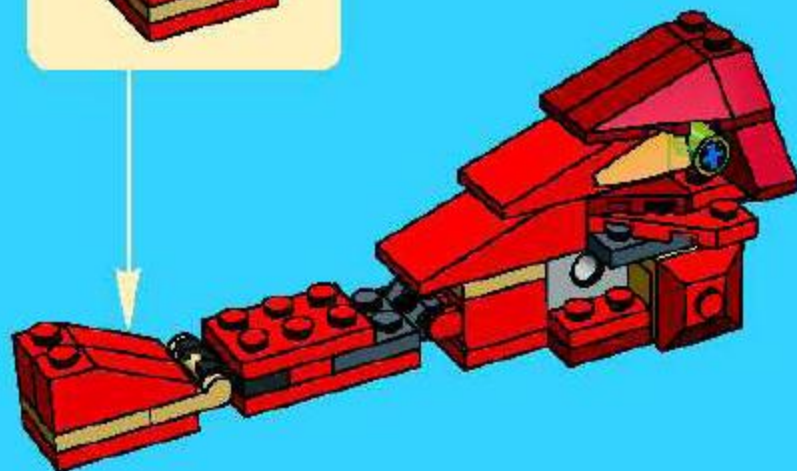



12

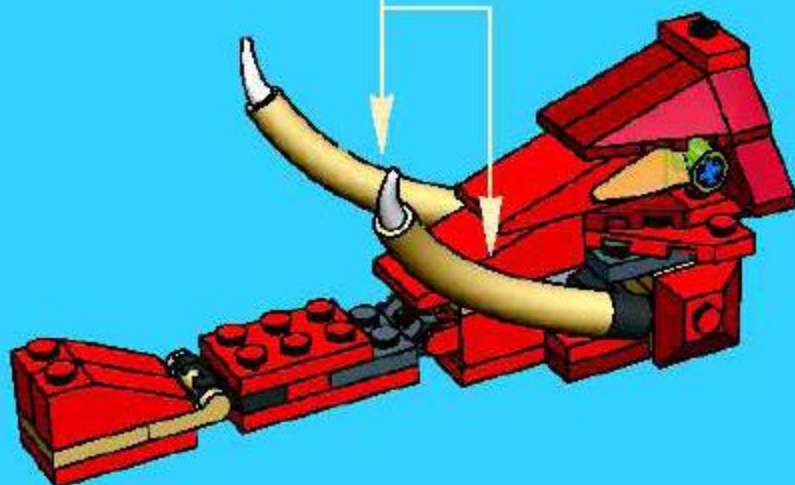
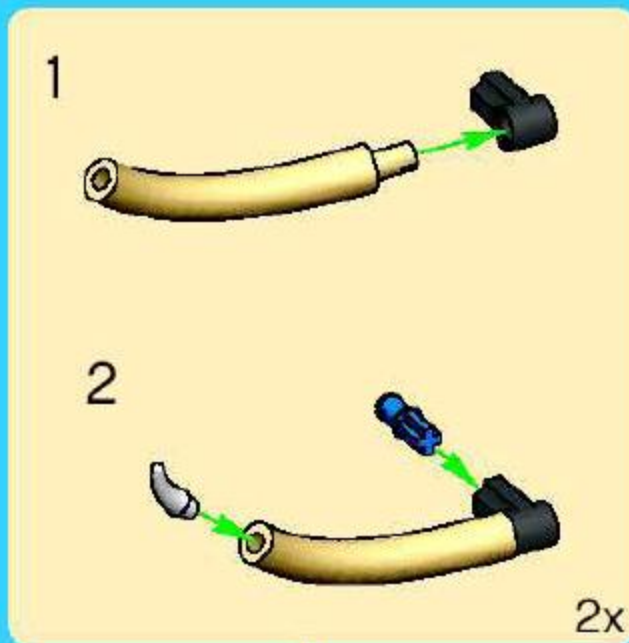

29

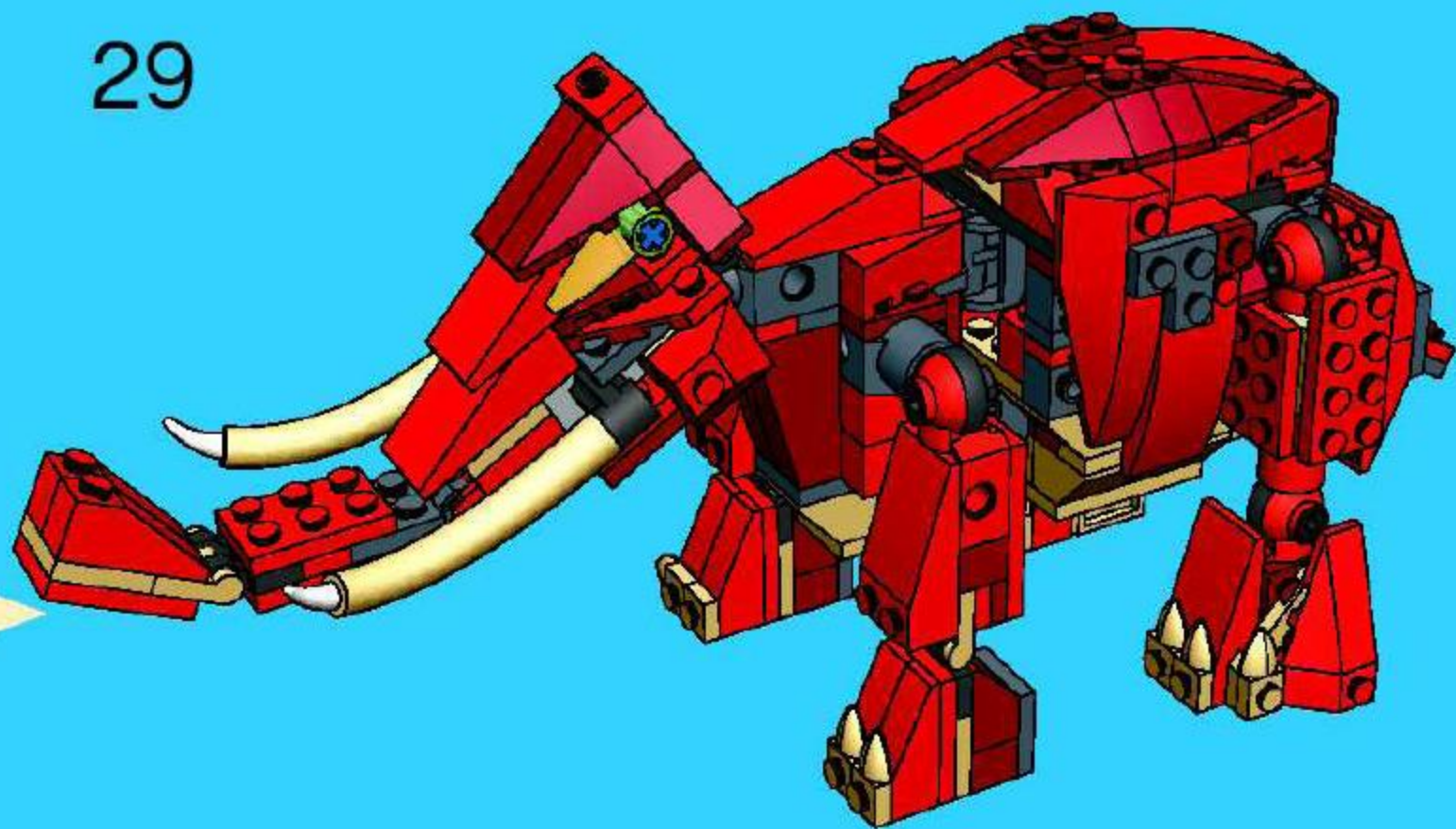

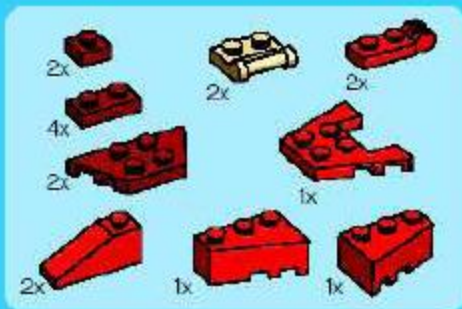

30

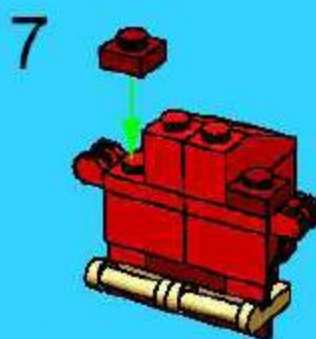

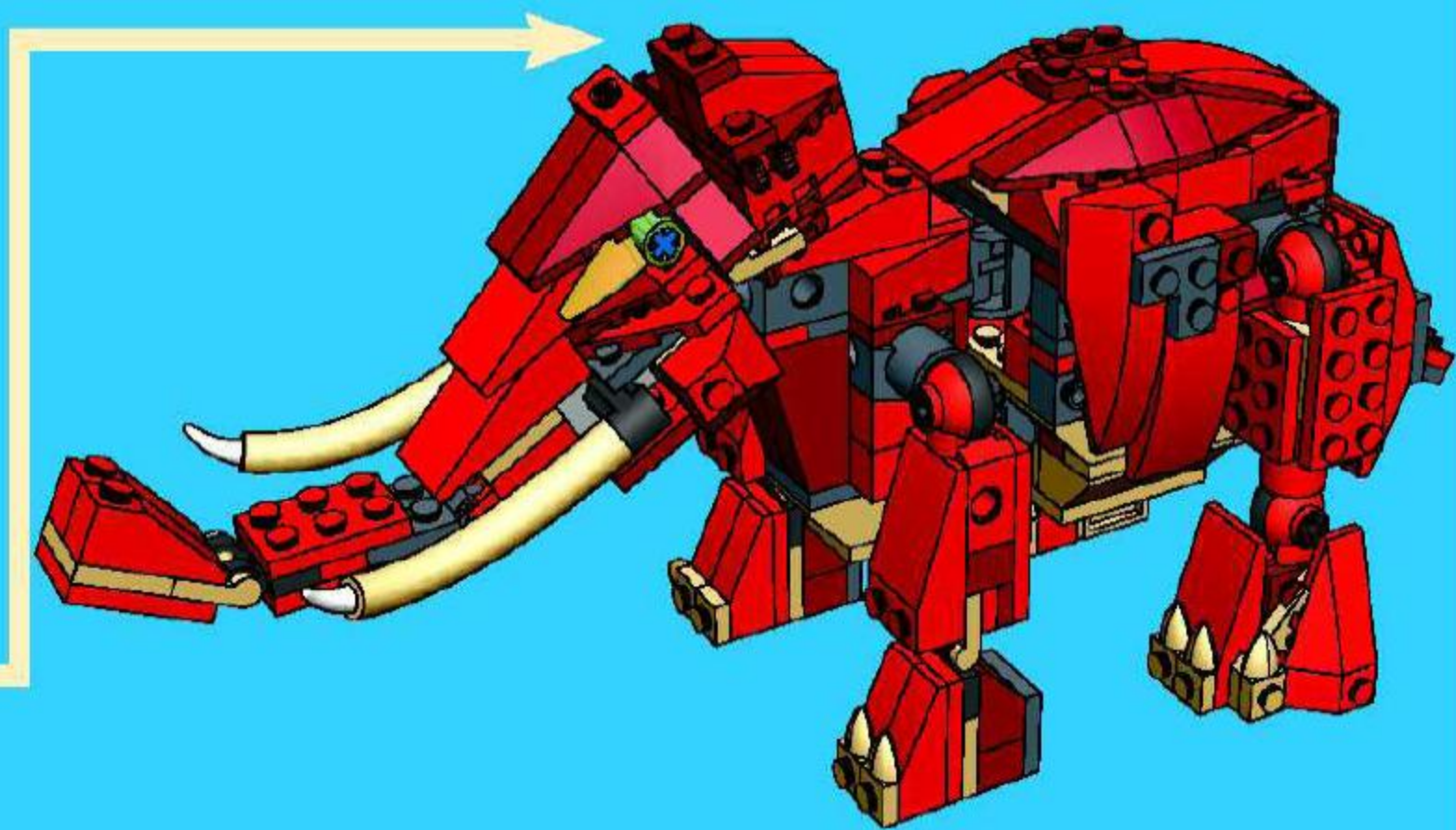

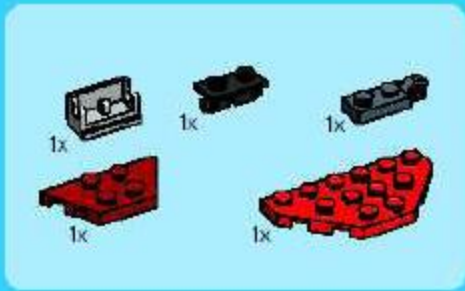

31

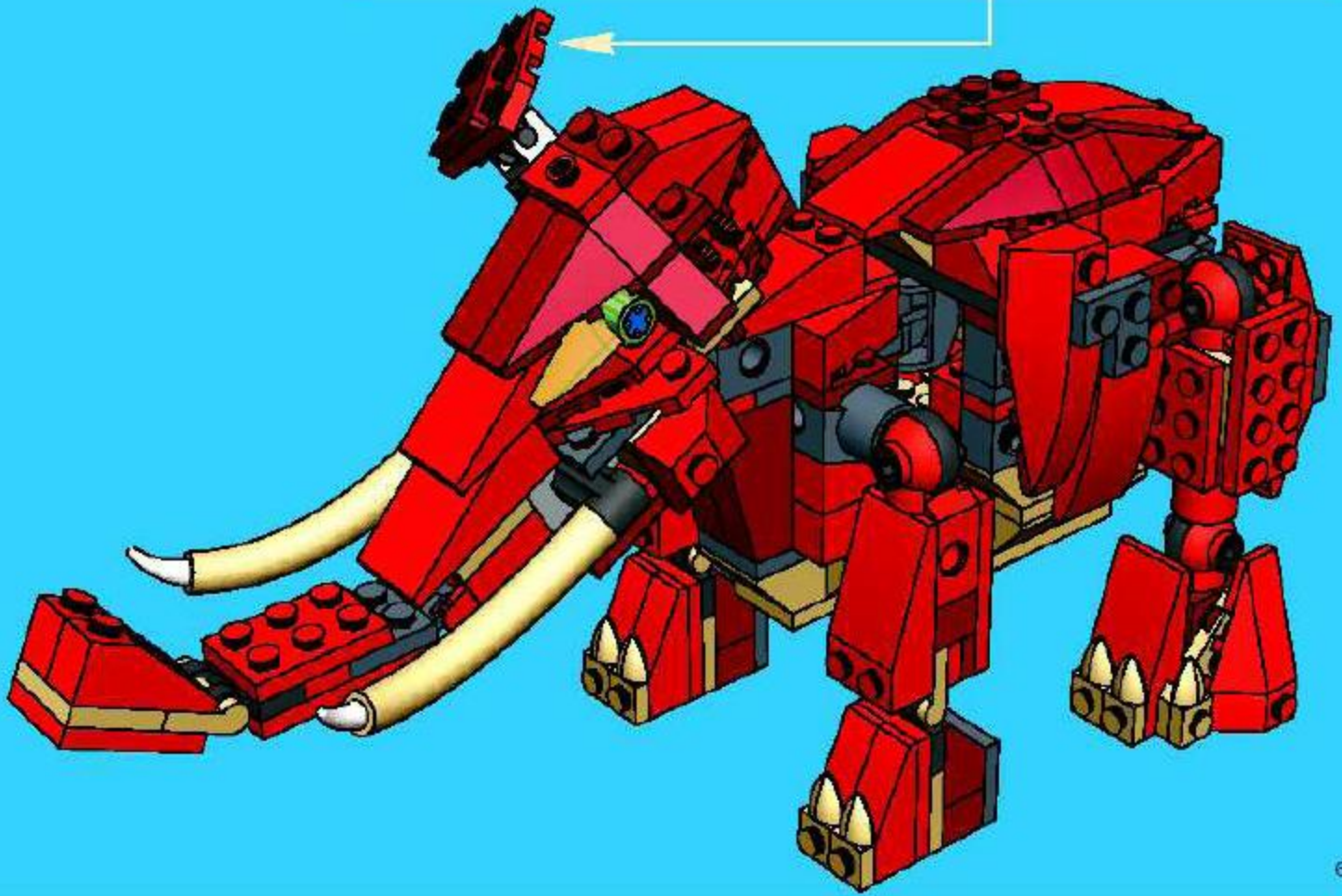
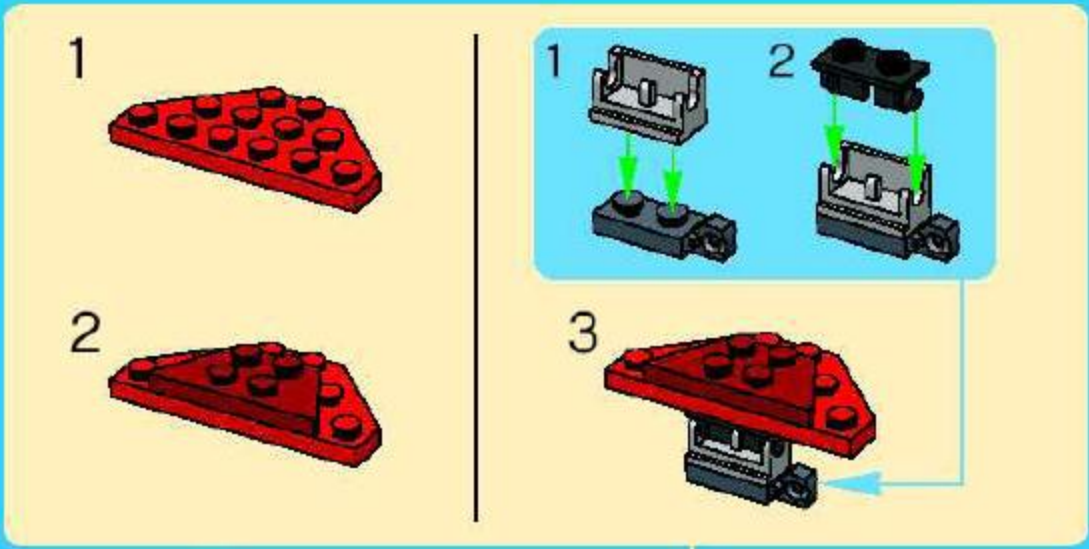

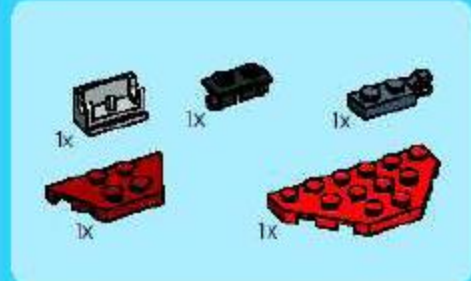

32

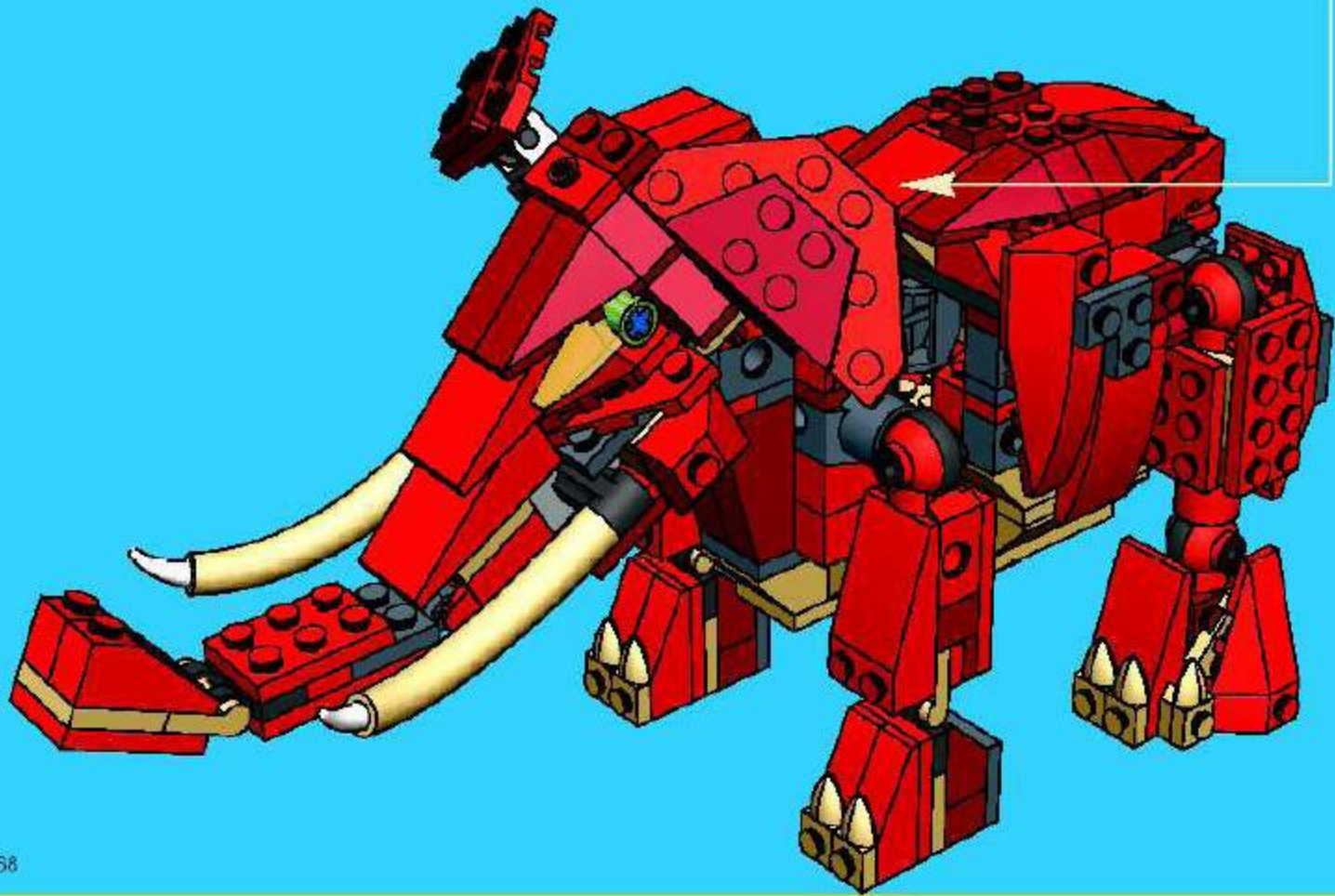
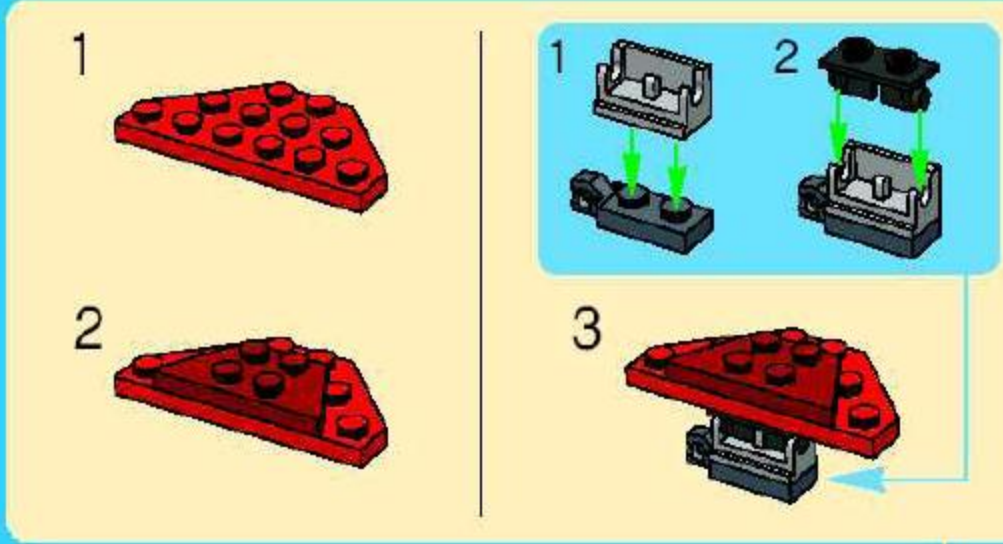



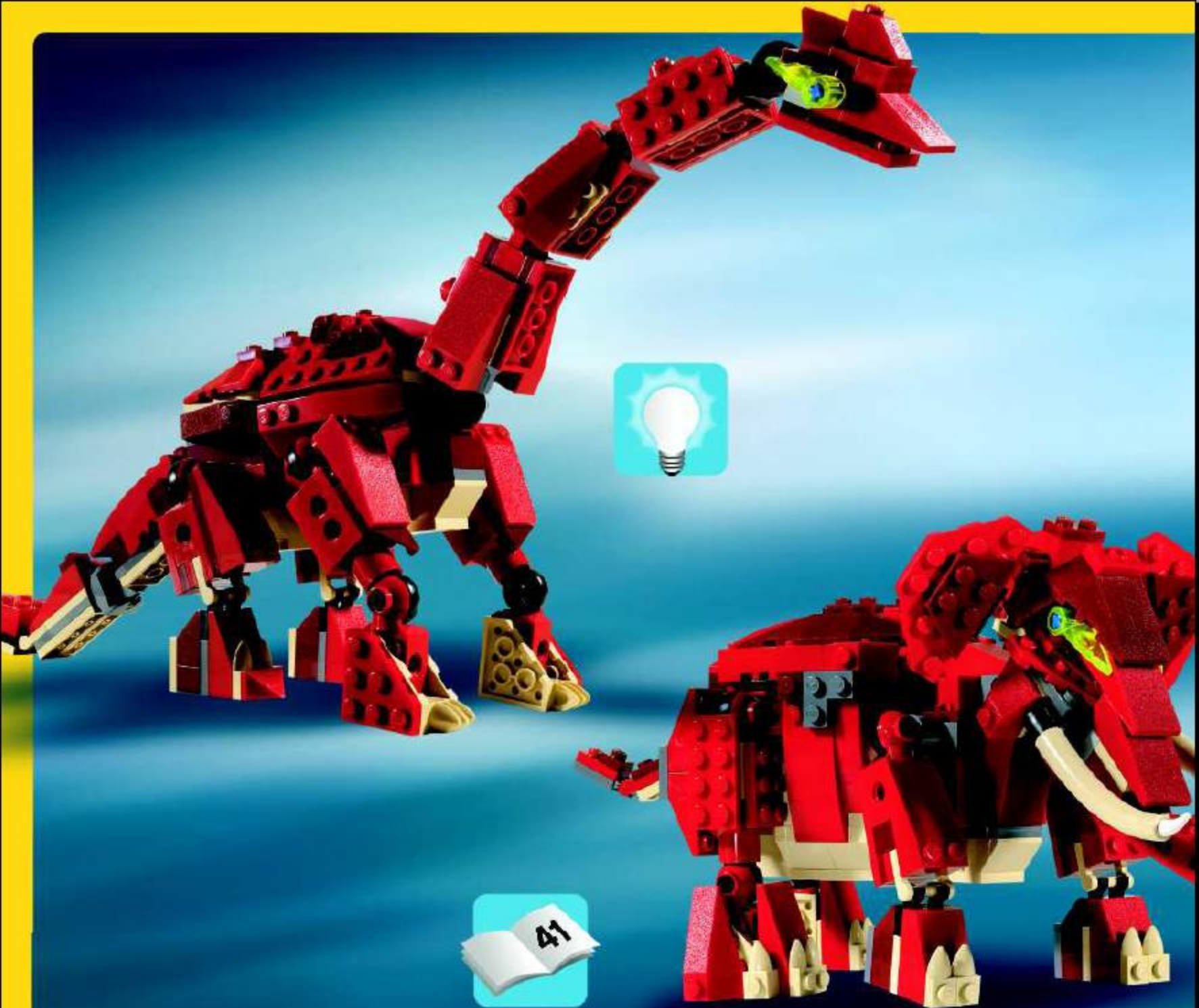





2x
4181138



3x
300121



2x
295721



3x
4180544



4x
650521



4x
656421



8x
428621



8x
4129539



4x
374721



3x
4251818



4x
4121934



4x
4225923



2x
4162628



1x
4280466



1x
4285467



2x
4163087



2x
4220515



1x
4258055



4x
4195004



2x
4287616



2x
4173322



2x
4180409



2x
4180419



4x
654121



4x
245021



2x
241921



2x
4178728



1x
4238305



8x
302121



10x
302021



4x
4183050



2x
4161412



2x
379421



12x
302321



6x
365621



2x
4181134



1x
414319



1x
4159739



5x
4112982



4x
4109995



14x
418806



1x
4113088



9x
4118790



4x
4114054



3x
4113233



4x
4243824



6x
4208072



2x
4239402



3x
4129997



10x
4161734



5x
4217562



1x
4278046



10x
4224793



2x
4163577



2x
3005749



4x
4273397



7x
4257178



14x
4183454



6x
4209500



2x
4276180



18x
4162562



10x
4183901



11x
4164219



3x
4183068



3x
4183875



3x
4183876



4x
4206482



2x
4121715



2x
4264952



2x
4265488



5x
4225973



4x
4210725



2x
4210728



6x
4210635



4x
4211094



5x
4210883



2x
4210892



3x
4211210



2x
4211469



1x
4211440



2x
4227525



6x
379526



2x
393826



6x
4213374



10x
601925



2x
4107095

Discover the **LEGO® UNIVERSE!**
 Entdecke das **LEGO® UNIVERSUM!**
 Découvre **L'UNIVERS LEGO® !**

FREE LEGO Magazines
 Des Magazines LEGO GRATUITS !
 KOSTENLOSE LEGO Magazine



Sign up now! Jetzt anmelden! Abonne-toi maintenant !

<http://club.LEGO.com/signup>

SHOP at HOME



www.LEGOshop.com/catalog

Win! Gagne! 当たります Gewinne!

Win LEGO products

We would like to know what you think about your new LEGO product. Log on to the web address below for further instructions.

Gagne des produits LEGO

Nous aimerions savoir ce que tu penses de ton nouveau produit LEGO. Tu obtiendras davantage d'informations en visitant le site Internet indique ci-dessous.

Gewinne LEGO produkte

Wir sind sehr an deiner Meinung über dein neues LEGO Produkt interessiert. Gehe einfach zu der unten angegebenen Webadresse – dort findest du weitere Informationen.

Estimado usuario LEGO

Al contestar algunas preguntas en inglés, francés, alemán o japonés, en el sitio www.acnielsen.aim.dk/lego, podrás participar en el sorteo de algunos valiosos premios LEGO.

Caro Consumidor da LEGO

Ao responder a algumas perguntas em Inglês, Francês, Alemão ou Japonês no endereço www.acnielsen.aim.dk/lego irá participar num concurso para ganhar valiosos prémios da LEGO.

Kedves ifjú LEGO Vásárló

Ha ellátogatsz a www.acnielsen.aim.dk/lego honlapra és ott angol, francia, német vagy japán nyelven megválaszolsz néhány kérdést, akkor részt veszel egy versenyben, amelyben értékes LEGO díjakat nyerhetsz.

抽選でレゴ®製品が当たります

私たちは、皆さんがお買い求めのレゴ®製品についてどんな感想をお持ちか、知りたいを思っています。質問に答えて、楽しいレゴ製品の抽選に応募しませんか。アンケートの回答には、ほんの分ほどしかかかりません！詳しくは、以下のウェブアドレスまでアクセスして下さい。

www.acnielsen.aim.dk/LEGO



Any questions regarding your new LEGO product, please contact:

Customer Service | Kundenservice

Service Consommateurs | Servicio Al Consumidor

at www.lego.com/service or dial

 : 00800 5346 5555

 : 1-800-422-5346



CREATOR

4417



4416



4415



4418



©2006 The LEGO Group.



4891

